

**iMilani**

innovative  
italian  
ideas

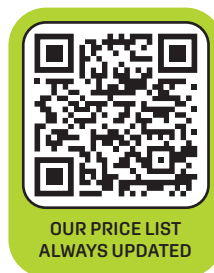

# TECHNOLOGY. DYNAMISM. PEOPLE.



*me716*

**iMiCUBE**

A brand of:  
**i'M**

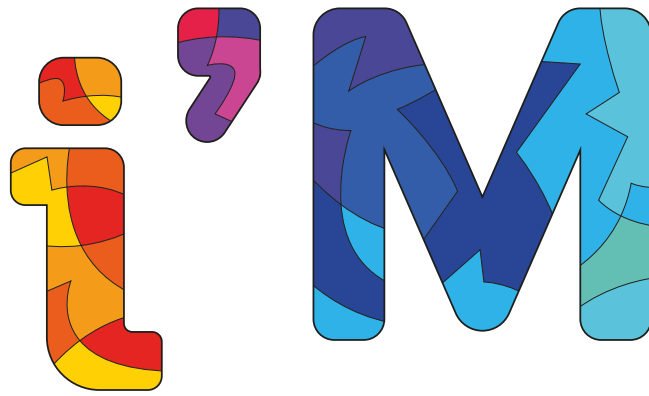

# i'M

## A GROUP, AN IDEOLOGY, THREE SPECIFIC AREAS OF MEMBERSHIP

We are people who regard research, innovation, sustainability and the human factor as indispensable values of any business. From kindergartens to work organisation, all the way to health plans: **i'M** is a family, a laboratory of ideas where the team determines the Group's success and outlines a strategy that favours not only the economic aspect, but also an efficient style of service that knows how to meet market demands.



Investments in training and innovation enable **Anicrin** to design and produce in vitro diagnostic devices and plastic medical instruments for the fields of bacteriology, clinical chemistry and pharmaceuticals, dynamically responding to the needs of scientific research.



From Montessori educational materials to furniture for kindergartens, schools, libraries and cultural centres, **GAM** imagines and designs interconnected and functional learning environments to support the individual in its growth and education.



For 50 years we have been looking for ethical and sustainable solutions for the molding of plastic bins.

We are people who believe in quality, innovation and sustainability as essential values in business, as guides to behaviour and as the real substance of any modern vision. These are the values we rely on to inform the everyday conduct of our work, with the deep conviction that espousing them does not invite the risk being unprepared for an already imminent future, with its need for interaction, speed and mutual satisfaction between customer and supplier, who, now more than ever, are partners in the challenge for competitiveness.

These are the values of our present and our past, rooted in **the story of an enterprise begun by Mario Milani in 1929** and carried forward by **Gianni Milani**. It was the latter who, in 1972, had the illuminated idea of the innovative importance of plastic containers as a tool to help businesses manage space more rationally.

Now the third generation will write the next chapter of this story with iMilani CEO **Roberto Milani**, who envisioned this new business venture as a natural consequence of the need to enter the market with a streamlined, "open space and open mind" production process.

**Gianluca Marzano**, also CEO of iMilani, follows the technical, marketing and commercial offices with his twenty-years experience as CEO in companies in this field.

iMilani is therefore eager to face the challenge of the present as a modern and reliable player, ready to accommodate the demands of the industrial world and of the wider community. Regarding the latter, it pursues 100% environmentally friendly policies and positions itself as an eco-sustainable company that prioritises the use of recycled and recyclable materials, within a controlled and fully internal production chain.

iMilani wants to serve customers with product lines tailored to their needs. It has thus come up with the "iMiCUBE" line, a series of boxes and containers with a wide usage spectrum and the "iMiLOG" line, a range of specialised containers designed exclusively for use with automatic systems, whether they are stacker cranes or mini-shuttles.

**iMilani is ready.**



**Roberto Milani**  
CEO

**Gianluca Marzano**  
CEO



## TEAM

# PEOPLE AT THE CENTRE OF THE SYSTEM

People are our strength, the vehicle to increase and develop knowledge, skills, design and experience that only people can activate.

We put our experience in designing standard products and customised solutions to suit all storage and handling requirements at the service of the customer. Together we define dimensions, openings and characteristics of the crates, from the choice of colour to the application of the logo, following customers from customization of the order to after-sales.

**Win:Win**  
 Chi fa del bene  
 vince sempre!



WIN:WIN

## THE SPORTS AND SOLIDARITY EVENT BETWEEN COMPANIES

Every year **iMilani** hosts the most highly awaited inter-company summer tournament. Born as a challenge between departments of the company itself, since 2015 it has taken the name **“Win:Win who does good always wins”** and today includes more than 20 participating and organising companies, which compete in football, beach volleyball and basketball.

The spirit that unites the companies is the desire to do sport, to create a bridge between companies and employees, enhance partnerships and concretely help the territory. The result is an event that involves the community and combines sport, fun, territory, music and ecology under a single objective: that of social commitment.

## THE BENEFICENT SOUL

The entire proceeds of the tournament have always been donated to the non-profit organisation "Le scarpette delle formichine" and other associations in the area that finance projects for the inclusion and reintegration of people in the community and the world of work, as well as supporting social and health facilities.



## VOLUNTEERS

Every year a team of volunteers devotes their time and enthusiasm to the organisation, preparation and service of the tournament, to ensure the best possible success of the evenings.

## THE PHOTO CONTEST

In each edition of the tournament, photography enthusiasts compete to capture the most special and significant moments of the evenings: athletes, spectators, the kitchen, volunteers and participants become the subjects of the photo contest. The shots of the registered participants will be voted by a social jury and a quality jury: the most voted ones will receive attractive prizes.

## WELFARE: LEARNING HOW TO LIVE BETTER

We care about the well-being of our team, because not only it improves the company productivity, but also determines a positive impact on the society.

We believe in the importance of listening to our collaborators and we are constantly working to offer a welfare program that concretely responds to the needs of workers.

### CONTINUOUS TRAINING FOR SPECIFIC SKILLS

iMilani supports the professional growth of its employees, providing professional and language training courses to its collaborators, which contribute to the formation of a diversified and competent team.

### A COMPLETE PREVENTION PROGRAMME

We are committed to ensuring and concretely improving the health of our employees by raising awareness of the importance of prevention and a balanced lifestyle. Thanks to the Sanbassiano Oncology Association, we have introduced in-company days dedicated to healthy eating and cancer prevention, to learn about one's own body and detect any physiological changes at an early stage. Added to these are the first physiotherapy project with a mobile clinic directly in the company thanks to the collaboration with Fisiolab 8.14 and the creation of a company gym. The iMilani team is periodically followed by physiotherapists and personal trainers who create a specific and complete programme of physiotherapy prevention and rehabilitation, through gym workouts, designed for the needs and objectives of each employee.



Fisiolab 8.14



iMiGYM



## WIN:WIN SUMMER CAMP

iMilani hosts the Win: Win Camp, the multisport summer camp dedicated to children who want to grow through sport and fun.



## SCHOOL-TO-WORK ALTERNATION

Every year we host local high school students who have to carry out an alternation school-to-work period, with the aim of consolidating through practical experience the knowledge acquired during their studies.

At iMilani we support and accompany students in their vocational training and in the process of enhancing and developing the transversal skills that the world of work requires.



ECOLOGY AND SUSTAINABILITY.

# BECAUSE THE EARTH IS THE MOST IMPORTANT VESSEL OF ALL

ALESSIA ZECCHINI

APNEA WORLD CHAMPION  
WORLD RECORD HOLDER



The planet is the biggest home we have. The home that someone tomorrow will live in without even having anticipated it. It is a home open to anyone. It is perfect. That's how we find it, and how we should leave when we finally go. Or even better than we found it. We want to make the same commitment also when our plastic product reaches the end of its life, meaning after 450 years.

Environmental protection is a priority, not an option. And we don't just mean our surrounding environment, but also, and above all, that expanse of water so vast that it covers over 70% of the Earth's surface: the sea.

The iMilani commitment to recycling of post-consumption household plastic, involves the processing of more than 1200 tons per year: a little contribution towards a "Plastic-free Sea".





Our commitment to environmental protection is concretely translated into the **Ghostnet Campaign**, the operation supported together with **Sea Shepherd Italy** aimed at fighting “ghost nets”, fishing gear made of plastic that are abandoned in the seas and deposited on the seabed, polluting the environment and threatening the marine ecosystem.

Together with Sea Shepherd Italy we are committed to recovering hundreds of thousands of ghost nets to process them into a new recycled and recyclable product, useful for new Sea Shepherd operations.

But we should not view plastic as a demon, but rather as we would the clay of the ancients, lending itself to man's imagination and taking on forms and applications useful to us in everyday life, giving rein to the imaginative project, “*Plastic-free Sea*”.



ACADiMi



Emotion Centre



## EMOTION CENTRE

# THE FUTURE IS A CONTAINER OF INNOVATION

Everyone talks about innovation. We like to make it happen.

We strongly believe in this word, we put it into effect and place it at the heart of every design, every product and every process we create.

The iMilani Emotion Centre is intended to be a representation of our history and technological evolution in plastic crate moulding. From the first container to today, we have innovated our production processes, producing sustainable products that adapt to every logistical and storage need.



# MATERIAL: POLYPROPYLENE AT ITS BEST

## TOP QUALITY POLYPROPYLENE AND POLYPROPYLENE FOR FOOD PRODUCTS

PP

Top quality polypropylene is a non-toxic, odourless plastic that is resistant to solvents and acids. It can be washed and sterilised and is water-resistant and non-hygroscopic. Its chemical and mechanical properties make it perfect for the manufacture of boxes and containers, ideal for handling in automatic warehouses.



### Food safety

Polypropylene for food use is a material that conforms to current EU legislation governing the characteristics of packaging and containers for contact with food. This plastic material is very widespread in the food industry, from product preparation and packaging to storage and shipment.

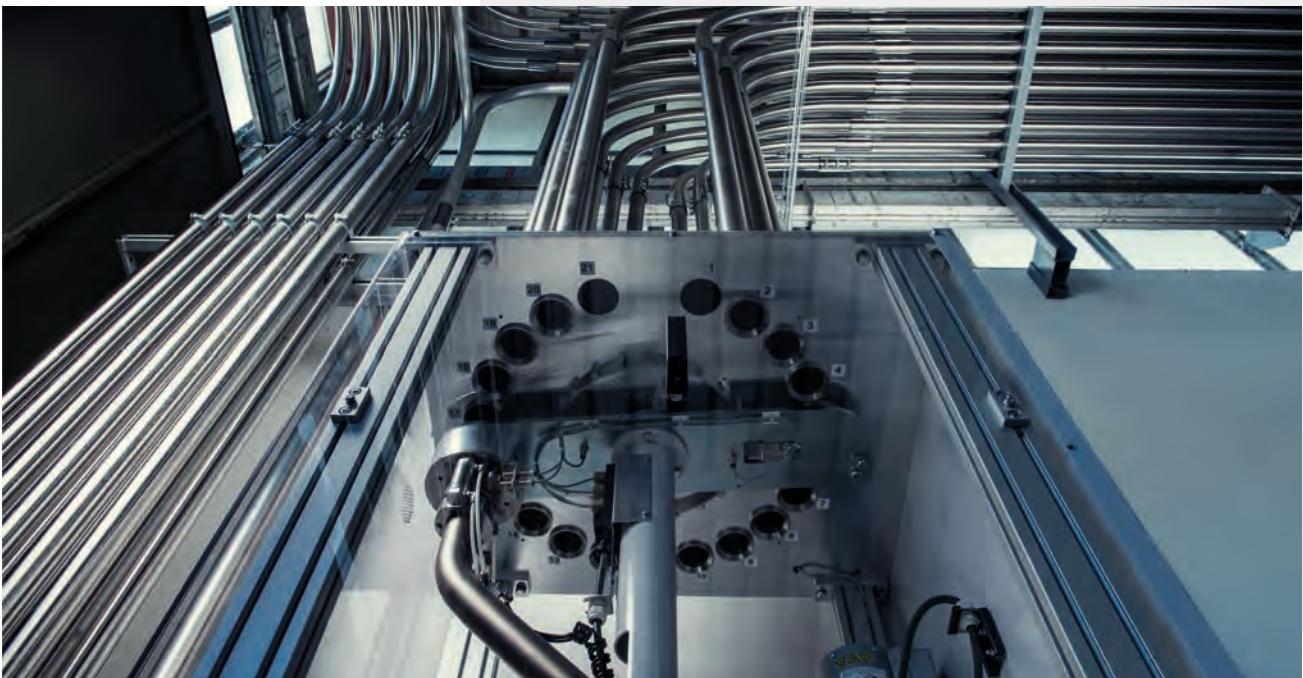

PP branching under presses.

## ECOGREEN



Ecogreen is an environmentally friendly solution that gives new life to recycled plastic, derived from the re-use of post-consumption plastic waste.

## CONDUCTIVE POLYPROPYLENE – ESD



Conductive polypropylene is a high-quality plastic, perfect for protection against electrostatic discharges. Boxes made from conductive polypropylene are perfect for storing and transporting sensitive electrical components.

## FIREPROOF POLYPROPYLENE CLASS V0

PP V0

Fireproof polypropylene, replicable in different colours, prevents fire risks in automated warehouses and is a viable alternative where the use of traditional fire sprinkler systems is not possible.



Impact test  
with pendulum.

## MATERIAL CHARACTERISATION DEPARTMENT

# THE RAW MATERIAL AT THE CENTRE OF OUR ATTENTION

When materials arrive at our company, the first thing they see are our laboratories. Each new arrival is carefully checked and certified according to our strict quality standards, with composition tests and mechanical, thermal and functional tests. Only materials that pass these tests are placed in our silos.

When the products have been moulded and the plastic has stabilised, this is the time for further tests: bottom bending and box structure resilience. Only after this process takes place products are released from the plant and sent to customers.



## MELT FLOW TESTER

This is a testing machine that determines the Melt Flow Rate of plastic, in other words the fluidity properties of the raw material in accordance with ASTM and ISO international standards.

This value is extremely important during the raw material transformation phase, because thermoplastic materials are processed under pressure and at a certain temperature. The ability of these melted materials to flow under pressure at a certain temperature is essential to the science and technology behind polymers.

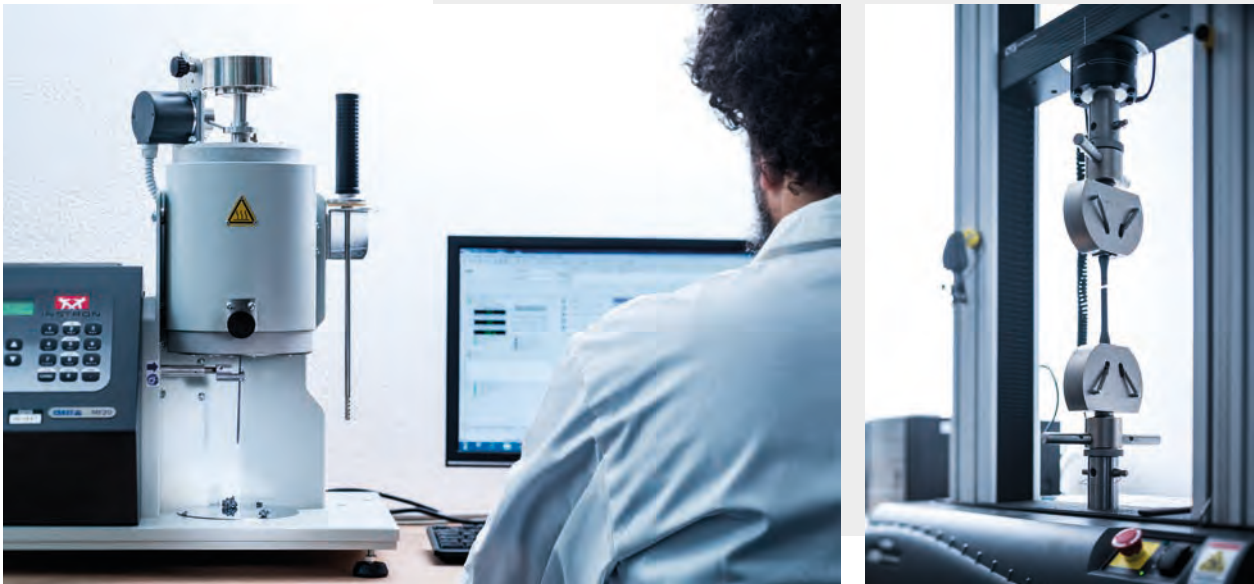

Melt Flow Tester.

## TRACTION TEST

During the product design phase, we need to optimise the usage of materials in order to create items that are strong, but also light and rigid at the same time. Two of the reference properties are elasticity and resistance to traction. The traction test is carried out using two vices that secure the extremities of specifically-shaped test pieces and subject them to traction. The test result is a value indicating the breakage or yield load of the raw material. When suitably measured with an extensometer, the test piece also provides the traction elasticity module. The machine is designed to carry out tests on a wide range of test pieces in accordance with ASTM and ISO international standards.

## IMPACT TEST WITH PENDULUM

For users of the materials, impact resistance is one of the most important properties. It provides an efficient assessment of the cost/performance ratio during product development and quality control.

Because components might yield when subjected to a force that is lesser than the critical breakage force, it is necessary to accurately determine the propagation of fractures following an impact. The pendulum machine is designed to carry out Charpy and Izod type tests on a wide range of test pieces in accordance with ASTM and ISO international standards.



MOULD DEPARTMENT

THE MOST INNOVATIVE  
INJECTION MOULDING  
IS MADE IN IMILANI

**18 injection** moulds operating on **3 shifts**.

From the moulding of small parts to boxes sized 800 x 600 mm. The moulds are designed for the application

of labels with an IML In-Mould Labelling system. This is used both for customisation and the application of barcodes, on-machine weighing and tolerance testing.



## THE PROCESS

The mixture of various “grains” and colours is heated until a homogeneous and mouldable paste is achieved. This is then inserted into the mould to create a product in the desired shape: a box, a finishing element or a mechanical part. The presses and moulds are connected via silos,

rollers, testing positions, and technical and commercial information systems making up the company’s control and value chain. At the end of the process each product is tested and checked to ensure that there are no imperfections. The product is delivered to the customer only if it is just perfect.



Roller conveyor

## NOISE TESTING AREA

# SILENCE AS A GUARANTEE

Innovation requires research, control and investment. We subject the totes to numerous quietness tests to ensure maximum acoustic comfort in the warehouse during their impact on the automatic roller conveyors.

The test area allows us to improve the surface and geometry of the totes, so as to avoid accidental breaks and promote maximum grip on the rollers of the conveyor systems, even at full load.

# iMiLOG

In addition to offering a wide range of boxes and containers, as well as accessories such as pallets and covers, iMilani also provides expertise in logistics automation.

In this regard, the **iMiLOG** specialist division can provide its technical staff for advice and the implementation of specific systems, using either the dedicated **SPACE** series or boxes and trays made to specific customer requirements.

**iMiLOG** works with leading manufacturers of logistics automation nationally and in Europe.

To request assistance from our technicians, send an email to [automation@imilog.it](mailto:automation@imilog.it)

Our boxes are integrated with the systems of:

**AUTOMHA**

**cassoli**  
AUTOMATIC MATERIAL HANDLING

CUBAR

DEMATIC

**Ferretto Group**  
on just one provider

**FRETOR**  
DROVEDAN  
CORPORATE LIFE

**JUNGHEINRICH**

**Logico**

**MECALUX**

**T&W**  
LIVING LOGISTICS

**trascar**  
AUTOMATION & LOGISTICS

**zancaner**  
Handling Automation & More



# Jo-Box

## THE AMR THAT OPTIMISES WAREHOUSE OPERATIONS FOR SMALL LOADS

**Jo-Box** is the Autonomous Mobile Robot (AMR) to support human labor; it is a compact and efficient system that moves within programmed routes performing the required missions.

Anyone can activate **Jo-Box** and call it to carry out a mission. The interface management software is extremely functional. Available A.P.I. for mission management by higher-level software.



From the **FMS** (Fleet Management System) web interface it is possible to view the status of the AMR fleet, remotely connect to each robot, assign tasks, consult the history of missions performed, view any alarm statuses, set preferred and repetitive missions.



From the **Map Editor** it is possible to define and edit the predetermined paths of the robots, the docking points and the navigation rules in each area of the work area



One or more maps on one or more layers, can be added and configured through a simple and intuitive interface



Through the **Fleet Lookout** it is possible to graphically view the progress of a fleet in real time and reconstruct the progress of a mission in all its parameters, instant by instant

# Jo3oX

**THE LOW COST AGV  
FOR HANDLING OF SMALL LOADS**





**iMilani**  
HQ



HQ



**anicrin**  
HQ



DISTRIBUTORS IMILANI



# I'M IN THE WORLD

---



CARPENTERY



**STORAGE  
COMPAT™**



**i'M**  
**Shanghai**



PP <b>2X</b> signal yellow RAL 1003	PP <b>05</b> yellow RAL 1021	PP <b>1C</b> melon yellow RAL 1028	PP <b>HE</b> signal orange RAL 2010	PP <b>24</b> deep orange RAL 2011
PP <b>2N</b> carmine RAL 3002	PP <b>1G</b> ruby red RAL 3003	PP <b>03</b> red RAL 3020	PP <b>JV</b> signal purple RAL 4008	PP <b>3Z</b> telemagenta RAL 4010
PP <b>04</b> blue PANTONE 660C	PP <b>XB</b> turquoise PANTONE 2925C	PP <b>3P</b> aqua blue RAL 5021	PP <b>27</b> signal blue RAL 5005	PP <b>IG</b> sapphire blue RAL 5003
PP <b>QD</b> leaf green RAL 6002	PP <b>JW</b> plastic green RAL 6011	PP <b>14</b> iMilani green PANTONE 382C	PP <b>2F</b> light green RAL 6027	PP <b>02</b> green RAL 6032
PP <b>1B</b> signal grey RAL 7004	PP <b>XL</b> anthracite grey RAL 7016	PP <b>08</b> light grey RAL 7035	PP <b>01</b> grey RAL 7046	PP <b>07</b> black RAL 9011

Colours on request +7%

## PERSONALISED MARKING

In addition to the application of adhesive or IML labels for RFID radio frequency tracking and barcode identification, it is possible to customise the bins with your company logo using two different systems, for quantity and shipment within 60 days of design approval:

- Logo embossed in the crates, obtained during the moulding stage, therefore the same colour as the boxes
- Hot marking using mobile characters or with a clichè accurate to the company logo.

Available colours:



Available in all colours

LOGISTIC



**NX** NEXIT 28



**AT** ATHENA 86 86



Discover our products

SPACE SAVER



**KR** KRONOS 98



**DE** DELTA 106



**MI** MINERVA 114

C-PARTS



**CO** COMPAT 120



**ZE** ZEUS 130



**PR** PRACTIBOX 136



**RK** RK 156

AUTOMOTIVE



**KLT** R-KLT 178



**KLT** RL-KLT 186



**KLT** 1421-KLT 194



**KLT** 4618-KLT  
4680-KLT 196



**OD** ODETTE 200

ACCESSORIES



**CA** MATS 206



**SA** SAFELID 208



**MO** MOTION 212



**CN** CONTAINER 216



**PA-CV** PALLET  
& COVER 222



**LH** HOLDER 230

STEEL



**STEEL** FOX 246



**STEEL** QUICK 260



**STEEL** FRAME 280



**STEEL** PICK 290



**STEEL** SQUARE 300

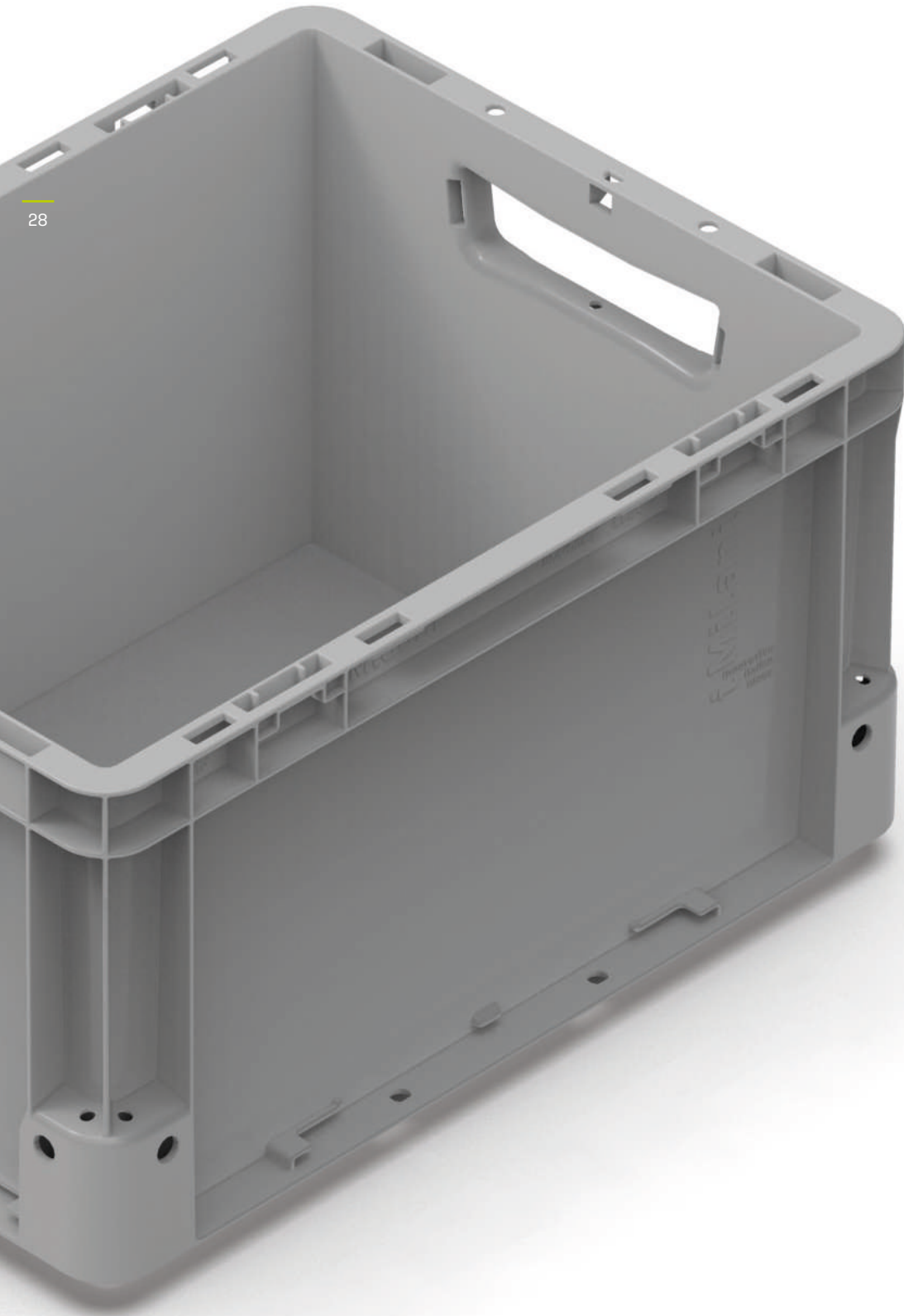

# NEXIT

The new **NEXIT** programme offers a complete range of solutions for any requirement.

Each EURO based dimension of this programme is available in different heights.

Each height offers aesthetic and functional

versions.

Available in the:

200x150 - 300x200 - 400x300 - 600x400 series, heights from:

75 - 120 - 170 - 220 - 270 - 320 - 420 mm.

## HANDLES

moulded closed



	H	75	120	170	220	270	320	420
200 x 150	■	■						
200 x 150	■	■						
300 x 200	■	■	■	■				
300 x 200	■	■	■	■				
400 x 300	■	■						
400 x 300	■	■	■	■	■			
600 x 400	■	■						
600 x 400	■	■	■	■				

open

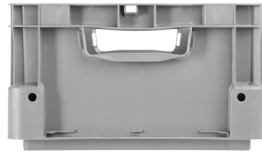

	H	75	120	170	220	270	320	420
400 x 300				■	■	■	■	
400 x 300								
600 x 400				■	■	■	■	■
600 x 400						■	■	■



## CARTER

1MICUBE

handles closing casing included \*



	H	75	120	170	220	270	320	420
400 x 300				■	■	■	■	
400 x 300								
600 x 400				■	■	■	■	■
600 x 400						■	■	■



\* supplied assembled

## BOTTOMS

closed bottom



load capacity 20 kg

reinforced bottom

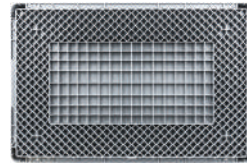

load capacity 50 kg

reinforced perforated bottom

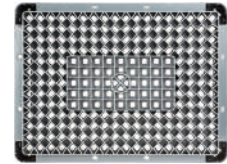

load capacity 50 kg

## WALLS

closed walls



perforated walls

only for 400 x 300  
and 600 x 400

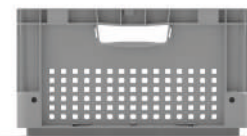

available in heights:  
120 - 170 - 220 - 270 - 320 - 420

picking

only for 400 x 300  
and 600 x 400



available in heights:  
220 - 270 - 320 - 420

## ACCESSORIES

separate lid



hinged lid



snap hinged lid

only for 200 x 150  
and 300 x 200



2 parts lid

only for 400 x 300  
and 600 x 400



# 200 x 150 mm H 75 mm

ARTICLE	WALLS		BOTTOM			HANDLES		GR.	PACKAGING		UNIT PRICE €
	Closed	Perforated	Closed	Perforated	Reinforced	Closed	Open		Qty. per pack.	Qty. per pallet	
NX 2108A 5101	■		■			■		184	32	1152	
NX 2108A 5401	■		■			■		192	32	1152	



**A**

Closed bottom  
Load capacity 15 kg



**A**

Stacked edge height	60 mm
Usable stacked height / with lid	57 mm / 61 mm
Usable internal dimensions	163 x 113 x 72 H mm
Volume	1,4 L
Pieces per package / pallet	📦 32 🚚 1152
Package dimensions	620 x 420 x 290 H mm
Pallet dimensions	1200 x 800 x 2325 H mm

**DATASHEET**

	ARTICLE	SEPARATE LID	HINGED LID	SNAP HINGED LID	GR.	PACKAGING		UNIT PRICE €	
						Qty. per pack.	Qty. per pallet		
1	NX 21SE 5101	■			72	1	1920		
	NX 21SE 5401	■			75	1	1920		
2	NX 21HG 5101		■		72	1	1920		
	NX 21HG 5401		■		75	1	1920		
3	NX 21HH 5101			■	73	1	1920		
	NX 21HH 5401			■	76	1	1920		
4	NX SEAL23 5113		1x	1x		500			



## DATASHEET

Separate lid	200 x 150 mm
1 Pieces per pack.	1
Pieces per pallet / dims.	1920 / 1200 x 800 x 942 H mm
Hinged lid	200 x 150 mm
2 Pieces per pack.	1
Pieces per pallet / dims.	1920 / 1200 x 800 x 942 H mm
Snap hinged lid	200 x 150 mm
3 Pieces per pack.	1
Pieces per pallet / dims.	1920 / 1200 x 800 x 942 H mm
Disposable security seal	
4 Pieces per pack	500

iMilani srl reserves the right to alter the characteristics of products without notice. The values shown are nominal, with a +/- 1% tolerance for size, depending on the material, and a +/- 3% for weight.

# 200 x 150 mm H 120 mm

ARTICLE	WALLS		BOTTOM			HANDLES		GR.	PACKAGING		UNIT PRICE €
	Closed	Perforated	Closed	Perforated	Reinforced	Closed	Open		Qty. per pack.	Qty. per pallet	
NX 2112A 5101	■		■			■		258	24	672	
NX 2112A 5401	■		■			■		269	24	672	



Closed bottom  
Load capacity 15 kg



**A**



**A**

Stacked edge height	105 mm
Usable stacked height / with lid	102 mm / 106 mm
Usable internal dimensions	163 x 113 x 117 H mm
Volume	2,3 L
Pieces per package / pallet	📦 24 🚚 672
Package dimensions	620 x 420 x 365 H mm
Pallet dimensions	1200 x 800 x 2370 H mm

**DATASHEET**



	ARTICLE	SEPARATE LID	HINGED LID	SNAP HINGED LID	GR.	PACKAGING		UNIT PRICE €	
						Qty. per pack.	Qty. per pallet		
1	NX 21SE 5101	■			72	1	1920		
	NX 21SE 5401	■			75	1	1920		
2	NX 21HG 5101		■		72	1	1920		
	NX 21HG 5401		■		75	1	1920		
3	NX 21HH 5101			■	73	1	1920		
	NX 21HH 5401			■	76	1	1920		
4	NX SEAL23 5113		1x	1x		500			



## DATASHEET

Separate lid	200 x 150 mm
1 Pieces per pack.	1
Pieces per pallet / dims.	1920 / 1200 x 800 x 942 H mm
Hinged lid	200 x 150 mm
2 Pieces per pack.	1
Pieces per pallet / dims.	1920 / 1200 x 800 x 942 H mm
Snap hinged lid	200 x 150 mm
3 Pieces per pack.	1
Pieces per pallet / dims.	1920 / 1200 x 800 x 942 H mm
Disposable security seal	
4 Pieces per pack	500

iMilani srl reserves the right to alter the characteristics of products without notice. The values shown are nominal, with a +/- 1% tolerance for size, depending on the material, and a +/- 3% for weight.

# 300 x 200 mm H 75 mm



ARTICLE	WALLS		BOTTOM			HANDLES		GR.	PACKAGING		UNIT PRICE €
	Closed	Perforated	Closed	Perforated	Reinforced	Closed	Open		Qty. per pack.	Qty. per pallet	
NX 3208A 5101	■		■			■		335	20	560	
NX 3208A 5401	■		■			■		350	20	560	

**A**

Closed bottom  
Load capacity 15 kg



**A**

Stacked edge height	60 mm
Usable stacked height / with lid	57 mm / 61 mm
Usable internal dimensions	261 x 161 x 72 H mm
Volume	3,2 L
Pieces per package / pallet	📦 20 🚚 560
Package dimensions	620 x 420 x 350 H mm
Pallet dimensions	1200 x 800 x 2325 H mm

**DATASHEET**

	ARTICLE	SEPARATE LID	HINGED LID	SNAP HINGED LID	GR.	PACKAGING		UNIT PRICE €	
						Qty. per pack.	Qty. per pallet		
1	NX 32SE 5101	■			138	1	1120		
	NX 32SE 5401	■			134	1	1120		
2	NX 32HG 5101		■		136	1	1120		
	NX 32HG 5401		■		142	1	1120		
3	NX 32HH 5101			■	137	1	1120		
	NX 32HH 5401			■	143	1	1120		
4	NX SEAL23 5113		2 x	2 x		500			



1



2



3



4

## DATASHEET

	Separate lid	300 x 200 mm
1	Pieces per pack.	1
	Pieces per pallet / dims.	1120/1200x800x1072Hmm
	Hinged lid	300 x 200 mm
2	Pieces per pack.	1
	Pieces per pallet / dims.	1120/1200x800x1072Hmm
	Snap hinged lid	300 x 200 mm
3	Pieces per pack.	1
	Pieces per pallet / dims.	1120/1200x800x1072Hmm
	Disposable security seal	
4	Pieces per pack	500

# 300 x 200 mm H 120 mm

ARTICLE	WALLS		BOTTOM			HANDLES		GR.	PACKAGING		UNIT PRICE €
	Closed	Perforated	Closed	Perforated	Reinforced	Closed	Open		Qty. per pack.	Qty. per pallet	
NX 3212A 5101	■		■			■		450	16	320	
NX 3212A 5401	■		■			■		470	16	320	











Closed bottom  
Load capacity 15 kg



A	
Stacked edge height	105 mm
Usable stacked height / with lid	102 mm / 106 mm
Usable internal dimensions	261 x 161 x 117 H mm
Volume	5,2 L
Pieces per package / pallet	📦 16 🚚 320
Package dimensions	620 x 420 x 470 H mm
Pallet dimensions	1200 x 800 x 2370 H mm

DATASHEET

	ARTICLE	SEPARATE LID	HINGED LID	SNAP HINGED LID	GR.	PACKAGING		UNIT PRICE €	
						Qty. per pack.	Qty. per pallet		
1	NX 32SE 5101	■			138	1	1120		 
	NX 32SE 5401	■			134	1	1120		
2	NX 32HG 5101		■		136	1	1120		 
	NX 32HG 5401		■		142	1	1120		
3	NX 32HH 5101			■	137	1	1120		 
	NX 32HH 5401			■	143	1	1120		
4	NX SEAL23 5113		2 x	2 x		500			 
5	LH TYT	Label holders - for long sides only				10			



1



2



3



4

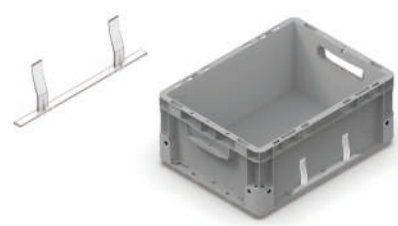

5

## DATASHEET

	Separate lid	300 x 200 mm
1	Pieces per pack.	📦 1
	Pieces per pallet / dimens.	📦 1120/1200x800x1072H mm
	Hinged lid	300 x 200 mm
2	Pieces per pack.	📦 1
	Pieces per pallet / dimens.	📦 1120/1200x800x1072H mm
	Snap hinged lid	300 x 200 mm
3	Pieces per pack.	📦 1
	Pieces per pallet / dimens.	📦 1120/1200x800x1072H mm
4	Disposable security seal	
	Pieces per pack	📦 500
5	Label holders	
	Pieces per pack	📦 10

# 300 x 200 mm H 170 mm

ARTICLE	WALLS		BOTTOM			HANDLES		GR.	PACKAGING		UNIT PRICE €
	Closed	Perforated	Closed	Perforated	Reinforced	Closed	Open		Qty. per pack.	Qty. per pallet	
NX 3217A 5101	■		■			■		552	12	240	
NX 3217A 5401	■		■			■		576	12	240	



Closed bottom  
Load capacity 15 kg











**A**



**A**

Stacked edge height	155 mm
Usable stacked height / with lid	152 mm / 156 mm
Usable internal dimensions	261 x 161 x 167 H mm
Volume	7,4 L
Pieces per package / pallet	📦 12 🚚 240
Package dimensions	620 x 420 x 515 H mm
Pallet dimensions	1200 x 800 x 2490 H mm

**DATASHEET**

	ARTICLE	SEPARATE LID	HINGED LID	SNAP HINGED LID	GR.	PACKAGING		UNIT PRICE €	
						Qty. per pack.	Qty. per pallet		
1	NX 32SE 5101	■			138	1	1120		 
	NX 32SE 5401	■			134	1	1120		
2	NX 32HG 5101		■		136	1	1120		 
	NX 32HG 5401		■		142	1	1120		
3	NX 32HH 5101			■	137	1	1120		 
	NX 32HH 5401			■	143	1	1120		
4	NX SEAL23 5113		2 x	2 x		500			 
5	LH TYT	Label holders - for long sides only				10			



1



2



3



4

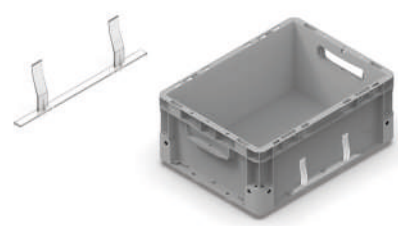

5

## DATASHEET

	Separate lid	300 x 200 mm
1	Pieces per pack.	📦 1
	Pieces per pallet / dims.	📦 1120/1200x800x1072Hmm
	Hinged lid	300 x 200 mm
2	Pieces per pack.	📦 1
	Pieces per pallet / dims.	📦 1120/1200x800x1072Hmm
	Snap hinged lid	300 x 200 mm
3	Pieces per pack.	📦 1
	Pieces per pallet / dims.	📦 1120/1200x800x1072Hmm
4	Disposable security seal	
	Pieces per pack	📦 500
5	Label holders	
	Pieces per pack	📦 10

	ARTICLE	WALLS		BOTTOM			HANDLES		GR.	PACKAGING		UNIT PRICE €
		Closed	Perforated	Closed	Perforated	Reinforced	Closed	Open		Qty. per pack.	Qty. per pallet	
A	NX 3222A 5101	■		■			■		654	8	160	
	NX 3222A 5401	■		■			■		683	8	160	

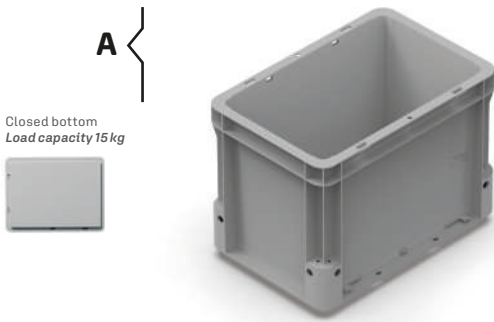

A	
Stacked edge height	205 mm
Usable stacked height / with lid	202 mm / 206 mm
Usable internal dimensions	261 x 161 x 217 H mm
Volume	9,6 L
Pieces per package / pallet	📦 8 🚚 160
Package dimensions	620 x 420 x 460 H mm
Pallet dimensions	1200 x 800 x 2215 H mm

DATASHEET



	ARTICLE	SEPARATE LID	HINGED LID	SNAP HINGED LID	GR.	PACKAGING		UNIT PRICE €	
						Qty. per pack.	Qty. per pallet		
1	NX 32SE 5101	■			138	1	1120		
	NX 32SE 5401	■			134	1	1120		ECOGREEN
2	NX 32HG 5101		■		136	1	1120		
	NX 32HG 5401		■		142	1	1120		ECOGREEN
3	NX 32HH 5101			■	137	1	1120		
	NX 32HH 5401			■	143	1	1120		ECOGREEN
4	NX SEAL23 5113		2 x	2 x		500			
5	LH TYT	Label holders - for long sides only				10			



1



2



3



4

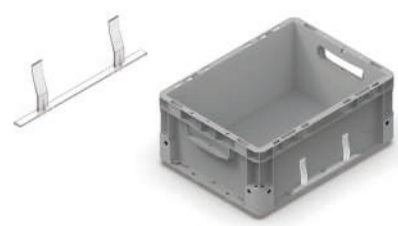

5

## DATASHEET

	Separate lid	300 x 200 mm
1	Pieces per pack.	1
	Pieces per pallet / dims.	1120/1200x800x1072H mm
	Hinged lid	300 x 200 mm
2	Pieces per pack.	1
	Pieces per pallet / dims.	1120/1200x800x1072H mm
	Snap hinged lid	300 x 200 mm
3	Pieces per pack.	1
	Pieces per pallet / dims.	1120/1200x800x1072H mm
4	Disposable security seal	
	Pieces per pack	500
5	Label holders	
	Pieces per pack	10

iMilani srl reserves the right to alter the characteristics of products without notice. The values shown are nominal, with a +/- 1% tolerance for size, depending on the material, and a +/- 3% for weight.

	ARTICLE	WALLS		BOTTOM			HANDLES		GR.	PACKAGING		UNIT PRICE €
		Closed	Perforated	Closed	Perforated	Reinforced	Closed	Open		Qty. per pack.	Qty. per pallet	
 ECOGREEN	A NX 4308A5101	■		■			■		595	14	280	
	A NX 4308A5401	■		■			■		621	14	280	
 ECOGREEN	C NX 4308C5101	■				■	■		810	14	280	
	<b>ARTICLE ON REQUEST</b>											
 ECOGREEN	C NX 4308C5401	■				■	■		864	14	280	

**A**

Closed bottom  
Load capacity 20 kg

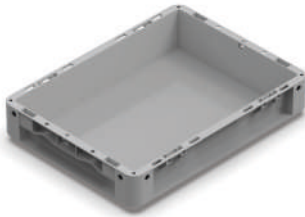

**C**

Reinforced bottom  
Load capacity 50 kg



**A**

Stacked edge height	60 mm
Usable stacked height / with lid	57 mm / 61 mm
Usable internal dimensions	361 x 261 x 72 H mm
Volume	6,9 L
Pieces per package / pallet	14  280
Package dimensions	620 x 420 x 470 H mm
Pallet dimensions	1200 x 800 x 2325 H mm

**C**

Stacked edge height	60 mm
Usable stacked height / with lid	45 mm / 49 mm
Usable internal dimensions	361 x 261 x 60 H mm
Volume	5,8 L
Pieces per package / pallet	14  280
Package dimensions	620 x 420 x 470 H mm
Pallet dimensions	1200 x 800 x 2325 H mm









DATASHEET

**ARTICLES ON REQUEST**

Minimum order.....200 boxes  
Guaranteed shipping within.....60 days

# 400 x 300 mm

iMICUBE

	ARTICLE	SEPARATE LID	HINGED LID	2 PARTS LID	GR.	PACKAGING		UNIT PRICE €	
						Qty. per pack.	Qty. per pallet		
1	NX 43SE 5101	■			327	1	480		
	NX 43SE 5401	■			341	1	480		
2	NX 43HG 5101		■		319	1	480		
	NX 43HG 5401		■		333	1	480		
3	NX 43CR 5101			■	486	1	480		
	NX 43CR 5401			■	508	1	480		
4	NX SEAL46 5113			2 x		500			
5	AT LOCK 8113		2 x			10			



1



2



3







4





5

## DATASHEET

Separate lid	400 x 300 mm
1 Pieces per pack.	 1
Pieces per pallet / dims.	 480 / 1200x800x870 H mm

Hinged lid	400 x 300 mm
2 Pieces per pack.	 1
Pieces per pallet / dims.	 480 / 1200x800x870 H mm

2-parts lid	400 x 300 mm
3 Pieces per pack.	 1
Pieces per pallet / dtmens.	 480 / 1200x800x870 H mm

Disposable security seal	
4 Pieces per pack	 500

Pair closing clips	
5 Pieces per pack	 10

iMilani srl reserves the right to alter the characteristics of products without notice. The values shown are nominal, with a +/- 1% tolerance for size, depending on the material, and a +/- 3% for weight.

	ARTICLE	WALLS		BOTTOM			HANDLES		GR.	PACKAGING		UNIT PRICE €
		Closed	Perforated	Closed	Perforated	Reinforced	Closed	Open		Qty. per pack.	Qty. per pallet	
♻️ ECO GREEN	A NX 4312A 5101	■		■			■		761	8	160	
	A NX 4312A 5401	■		■			■		794	8	160	
♻️	C NX 4312C 5101	■				■	■		976	8	160	
♻️	P NX 4312P 5101		■		■	■	■		914	8	160	
⚠️	ARTICLE ON REQUEST											
♻️	C NX 4312C 5401	■				■	■		1020	8	160	
♻️	P NX 4312P 5401		■		■	■	■		955	8	160	

**A**

Closed bottom  
Load capacity 20 kg



**C**

Reinforced bottom  
Load capacity 50 kg

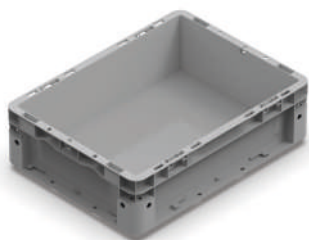

**P**

Reinforced perforated bottom  
Load capacity 50 kg



A	
Stacked edge height	105 mm
Usable stacked height / with lid	102 mm / 106 mm
Usable internal dimensions	361 x 261 x 117 H mm
Volume	11,3 L
Pieces per package / pallet	📦 8 🚚 160
Package dimensions	620 x 420 x 470 H mm
Pallet dimensions	1200 x 800 x 2370 H mm
C	
Stacked edge height	105 mm
Usable stacked height / with lid	90 mm / 94 mm
Usable internal dimensions	361 x 261 x 105 H mm
Volume	10,1 L
Pieces per package / pallet	📦 8 🚚 160
Package dimensions	620 x 420 x 470 H mm
Pallet dimensions	1200 x 800 x 2370 H mm
P	
Stacked edge height	105 mm
Usable stacked height / with lid	90 mm / 94 mm
Usable internal dimensions	361 x 261 x 105 H mm
Volume	10,1 L
Pieces per package / pallet	📦 8 🚚 160
Package dimensions	620 x 420 x 470 H mm
Pallet dimensions	1200 x 800 x 2370 H mm













DATASHEET

iMilani srl reserves the right to alter the characteristics of products without notice. The values shown are nominal, with a +/- 1% tolerance for size, depending on the material, and a +/- 3% for weight.

⚠️ **ARTICLES ON REQUEST**  
 Minimum order.....200 boxes  
 Guaranteed shipping within.....60 days

# 400 x 300 mm

iMICUBE

	ARTICLE	SEPARATE LID	HINGED LID	2 PARTS LID	GR.	PACKAGING		UNIT PRICE €	
						Qty. per pack.	Qty. per pallet		
1	NX 43SE 5101	■				327	1 480		 
	NX 43SE 5401	■				341	1 480		
2	NX 43HG 5101		■			319	1 480	 	
	NX 43HG 5401		■			333	1 480		
3	NX 43CR 5101			■		486	1 480	 	
	NX 43CR 5401			■		508	1 480		
4	NX SEAL46 5113			2 x			500	 	
5	AT LOCK 8113		2 x				10	 	
6	LH TYT	Label holders for all sides					10	 	



1



2



3



4











5



6

## DATASHEET

Separate lid	400 x 300 mm
1 Pieces per pack.	 1
Pieces per pallet / dims.	 480 / 1200x800x870 Hmm
Hinged lid	400 x 300 mm
2 Pieces per pack.	 1
Pieces per pallet / dims.	 480 / 1200x800x870 Hmm
2-parts lid	400 x 300 mm
3 Pieces per pack.	 1
Pieces per pallet / dims.	 480 / 1200x800x870 Hmm
Disposable security seal	
4 Pieces per pack	 10
Pair closing clips	
5 Pieces per pack	 500
Label holders	
6 Pieces per pack	 10

iMilani srl reserves the right to alter the characteristics of products without notice. The values shown are nominal, with a +/- 1% tolerance for size, depending on the material, and a +/- 3% for weight.

	ARTICLE	WALLS		BOTTOM			HANDLES		GR.	PACKAGING		UNIT PRICE €
		Closed	Perforated	Closed	Perforated	Reinforced	Closed	Open		Qty. per pack.	Qty. per pallet	
	B NX 4317B 5101	■		■			■		899	6	120	
	A NX 4317A 5401	■		■			■		939	6	120	
	D NX 4317D 5101	■				■		■	1115	6	120	
	S NX 4317S 5101		■		■	■		■	1034	6	120	
	ARTICLE ON REQUEST											
	C NX 4317C 5401	■				■	■		1165	6	120	
	P NX 4317P 5401		■		■	■	■		1081	6	120	

Closed bottom  
Load capacity 20 kg



A\* - B

Reinforced bottom  
Load capacity 50 kg



C\* - D

Reinforced perforated bottom  
Load capacity 50 kg



P\* - S

### A - B

Stacked edge height	155 mm
Usable stacked height / with lid	152 mm / 156 mm
Usable internal dimensions	361 x 261 x 167 H mm
Volume	16,1 L
Pieces per package / pallet	6  120
Package dimensions	620 x 420 x 515 H mm
Pallet dimensions	1200 x 800 x 2490 H mm

### C - D

Stacked edge height	155 mm
Usable stacked height / with lid	140 mm / 144 mm
Usable internal dimensions	361 x 261 x 155 H mm
Volume	15 L
Pieces per package / pallet	6  120
Package dimensions	620 x 420 x 515 H mm
Pallet dimensions	1200 x 800 x 2490 H mm

### P - S

Stacked edge height	155 mm
Usable stacked height / with lid	140 mm / 144 mm
Usable internal dimensions	361 x 261 x 155 H mm
Volume	15 L
Pieces per package / pallet	6  120
Package dimensions	620 x 420 x 515 H mm
Pallet dimensions	1200 x 800 x 2490 H mm

DATASHEET

\* **ECOGREEN** with closed moulded handle













iMilani srl reserves the right to alter the characteristics of products without notice. The values shown are nominal, with a +/- 1% tolerance for size, depending on the material, and a +/- 3% for weight.

#### ARTICLES ON REQUEST

Minimum order.....200 boxes  
Guaranteed shipping within.....60 days

# 400 x 300 mm

iMICUBE

	ARTICLE	SEPARATE LID	HINGED LID	2 PARTS LID	GR.	PACKAGING		UNIT PRICE €	
						Qty. per pack.	Qty. per pallet		
1	NX 43SE 5101	■				327	1 480		 
	NX 43SE 5401	■				341	1 480		
2	NX 43HG 5101		■			319	1 480		 
	NX 43HG 5401		■			333	1 480		
3	NX 43CR 5101			■		486	1 480		 
	NX 43CR 5401			■		508	1 480		
4	NX SEAL46 5113			2 x			500		 
5	AT LOCK 8113		2 x				10		 
6	LH TYT	Label holders for all sides					10		 



1



2



3



4











5



6

## DATASHEET

	Separate lid	400 x 300 mm
1	Pieces per pack.	 1
	Pieces per pallet / dimens.	 480 / 1200x800x870 Hmm
	Hinged lid	400 x 300 mm
2	Pieces per pack.	 1
	Pieces per pallet / dimens.	 480 / 1200x800x870 Hmm
	2-parts lid	400 x 300 mm
3	Pieces per pack.	 1
	Pieces per pallet / dimens.	 480 / 1200x800x870 Hmm
	Disposable security seal	
4	Pieces per pack	 10
	Pair closing clips	
5	Pieces per pack	 500
	Label holders	
6	Pieces per pack	 10

iMilani srl reserves the right to alter the characteristics of products without notice. The values shown are nominal, with a +/- 1% tolerance for size, depending on the material, and a +/- 3% for weight.

	ARTICLE	WALLS		BOTTOM			HANDLES		GR.	PACKAGING		UNIT PRICE €
		Closed	Perforated	Closed	Perforated	Reinforced	Closed	Open		Qty. per pack.	Qty. per pallet	
	B NX 4322B 5101	■		■			■		1146	4	80	
	A NX 4322A 5401	■		■			■		1198	4	80	
	D NX 4322D 5101	■				■	■		1257	4	80	
	ARTICLE ON REQUEST											
	C NX 4322C 5401	■				■	■		1314	4	80	

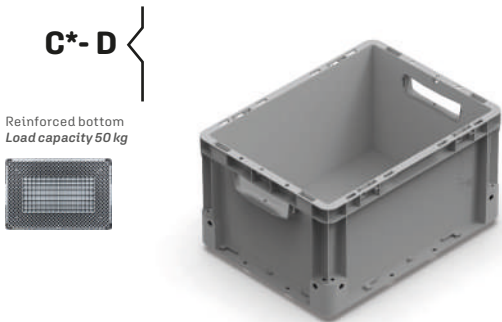
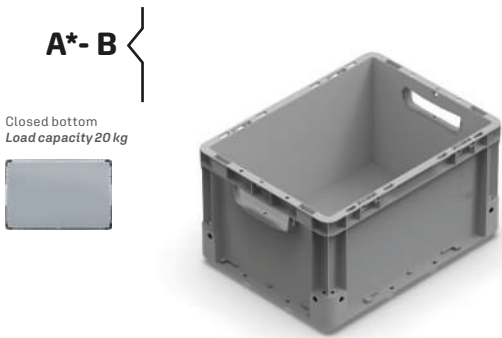

A - B	
Stacked edge height	205 mm
Usable stacked height / with lid	202 mm / 206 mm
Usable internal dimensions	361 x 261 x 217 H mm
Volume	20,9 L
Pieces per package / pallet	4  80
Package dimensions	620 x 420 x 460 H mm
Pallet dimensions	1200 x 800 x 2215 H mm
C - D	
Stacked edge height	205 mm
Usable stacked height / with lid	190 mm / 194 mm
Usable internal dimensions	361 x 261 x 205 H mm
Volume	19,8 L
Pieces per package / pallet	4  80
Package dimensions	620 x 420 x 460 H mm
Pallet dimensions	1200 x 800 x 2215 H mm

DATASHEET

\* **ECOGREEN** with closed moulded handle

CONTINUED ON NEXT PAGE



iMilani srl reserves the right to alter the characteristics of products without notice. The values shown are nominal, with a +/- 1% tolerance for size, depending on the material, and a +/- 3% for weight.













**ARTICLES ON REQUEST**

Minimum order.....200 boxes  
Guaranteed shipping within.....60 days



# 400 x 300 mm

iMICUBE

	ARTICLE	SEPARATE LID	HINGED LID	2 PARTS LID	GR.	PACKAGING		UNIT PRICE €	
						Qty. per pack.	Qty. per pallet		
1	NX 43SE 5101	■				327	1 480		 
	NX 43SE 5401	■				341	1 480		
2	NX 43HG 5101		■			319	1 480		 
	NX 43HG 5401		■			333	1 480		
3	NX 43CR 5101			■		486	1 480		 
	NX 43CR 5401			■		508	1 480		
4	NX SEAL46 5113			2 x			500		 
5	AT LOCK 8113		2 x				10		 
6	LH TYT	Label holders for all sides					10		 



1



2



3



4











5



6

## DATASHEET

	Separate lid	400 x 300 mm
1	Pieces per pack.	 1
	Pieces per pallet / dimens.	 480 / 1200x800x870 Hmm
	Hinged lid	400 x 300 mm
2	Pieces per pack.	 1
	Pieces per pallet / dimens.	 480 / 1200x800x870 Hmm
	2-parts lid	400 x 300 mm
3	Pieces per pack.	 1
	Pieces per pallet / dimens.	 480 / 1200x800x870 Hmm
	Disposable security seal	
4	Pieces per pack	 10
	Pair closing clips	
5	Pieces per pack	 500
	Label holders	
6	Pieces per pack	 10

iMilani srl reserves the right to alter the characteristics of products without notice. The values shown are nominal, with a +/- 1% tolerance for size, depending on the material, and a +/- 3% for weight.

	ARTICLE	WALLS			BOTTOM			HANDLES		GR.	PACKAGING		UNIT PRICE €
		Closed	Perforated	Picking short side	Closed	Perforated	Reinforced	Closed	Open		Qty. per pack.	Qty. per pallet	
	S NX 4322S 5101	■				■	■		■	1153	4	80	
	U NX 4322U 5101			■	■				■	1080	4	80	
	ARTICLE ON REQUEST												
	P NX 4322P 5401	■				■	■	■		1205	4	80	
	V NX 4322V 5401			■	■			■		1129	4	80	

Reinforced perforated bottom  
Load capacity 50 kg



Closed bottom  
Load capacity 20 kg

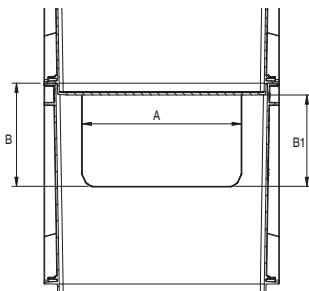
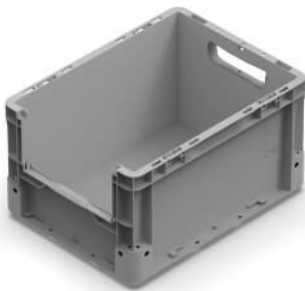

<b>A</b>	202
<b>B</b>	106
<b>B1</b>	91

\* **ECOGREEN** with closed moulded handle

◀◀ CONTINUED ON PREVIOUS PAGE

iMilani srl reserves the right to alter the characteristics of products without notice. The values shown are nominal, with a +/- 1% tolerance for size, depending on the material, and a +/- 3% for weight.

### P - S

Stacked edge height	205 mm
Usable stacked height / with lid	190 mm / 194 mm
Usable internal dimensions	361 x 261 x 205 H mm
Volume	19,8 L
Pieces per package / pallet	4  80
Package dimensions	620 x 420 x 460 H mm
Pallet dimensions	1200 x 800 x 2215 H mm

### V - U

Stacked edge height	205 mm
Usable stacked height / with lid	202 mm / 206 mm
Usable internal dimensions	361 x 261 x 217 H mm
Volume	20,9 L
Pieces per package / pallet	4  80
Package dimensions	620 x 420 x 460 H mm
Pallet dimensions	1200 x 800 x 2215 H mm











DATASHEET

**ARTICLES ON REQUEST**

Minimum order.....200 boxes  
Guaranteed shipping within.....60 days

# 400 x 300 mm

iMICUBE

	ARTICLE	SEPARATE LID	HINGED LID	2 PARTS LID	GR.	PACKAGING		UNIT PRICE €	
						Qty. per pack.	Qty. per pallet		
1	NX 43SE 5101	■			327	1	480		
	NX 43SE 5401	■			341	1	480		
2	NX 43HG 5101		■		319	1	480		
	NX 43HG 5401		■		333	1	480		
3	NX 43CR 5101			■	486	1	480		
	NX 43CR 5401			■	508	1	480		
4	NX SEAL46 5113			2 x		500			
5	AT LOCK 8113		2 x			10			
6	LH TYT	Label holders for all sides				10			
7	NX WC43226896	H220 Door				1			



1



2



3



4



5













6







7





## DATASHEET

Separate lid	400 x 300 mm
1 Pieces per pack.	 1
Pieces per pallet / dimens.	 480 / 1200x800x870 Hmm
Hinged lid	400 x 300 mm
2 Pieces per pack.	 1
Pieces per pallet / dimens.	 480 / 1200x800x870 Hmm
2-parts lid	400 x 300 mm
3 Pieces per pack.	 1
Pieces per pallet / dimens.	 480 / 1200x800x870 Hmm
Disposable security seal	
4 Pieces per pack	 500
Pair closing clips	
5 Pieces per pack	 10
Label holders	
6 Pieces per pack	 10
H220 Door	
7 Pieces per pack	 1

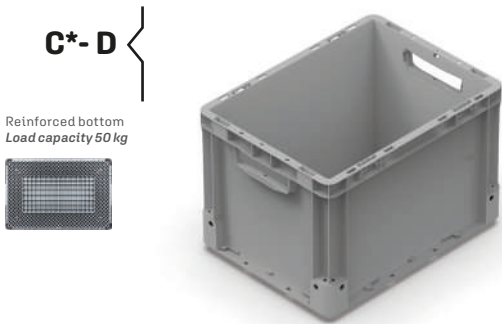
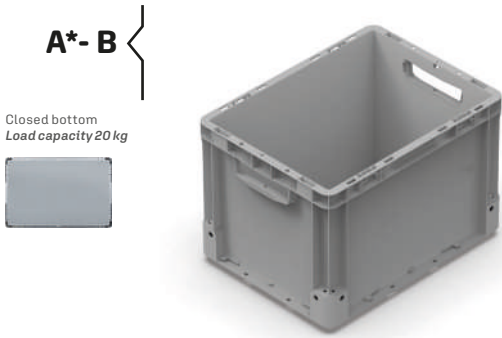
iMilani srl reserves the right to alter the characteristics of products without notice. The values shown are nominal, with a +/- 1% tolerance for size, depending on the material, and a +/- 3% for weight.

	ARTICLE	WALLS		BOTTOM			HANDLES		GR.	PACKAGING		UNIT PRICE €
		Closed	Perforated	Closed	Perforated	Reinforced	Closed	Open		Qty. per pack.	Qty. per pallet	
	<b>B</b> NX 4327B 5101	■		■			■		1186	4	64	
	<b>A</b> NX 4327A 5401	■		■			■		1239	4	64	
	<b>D</b> NX 4327D 5101	■				■		■	1401	4	64	
	ARTICLE ON REQUEST											
	<b>C</b> NX 4327C 5401	■				■	■		1463	4	64	



A - B	
Stacked edge height	255 mm
Usable stacked height / with lid	252 mm / 256 mm
Usable internal dimensions	361 x 261 x 267 H mm
Volume	25,8 L
Pieces per package / pallet	 4  64
Package dimensions	620 x 420 x 560 H mm
Pallet dimensions	1200 x 800 x 2205 H mm
C - D	
Stacked edge height	255 mm
Usable stacked height / with lid	240 mm / 244 mm
Usable internal dimensions	361 x 261 x 255 H mm
Volume	24,6 L
Pieces per package / pallet	 4  64
Package dimensions	620 x 420 x 560 H mm
Pallet dimensions	1200 x 800 x 2205 H mm

DATASHEET

\* **ECOGREEN** with closed moulded handle

CONTINUED ON NEXT PAGE









iMilani srl reserves the right to alter the characteristics of products without notice. The values shown are nominal, with a +/- 1% tolerance for size, depending on the material, and a +/- 3% for weight.

 **ARTICLES ON REQUEST**

Minimum order.....200 boxes  
Guaranteed shipping within.....60 days

# 400 x 300 mm

iMICUBE

	ARTICLE	SEPARATE LID	HINGED LID	2 PARTS LID	GR.	PACKAGING		UNIT PRICE €	
						Qty. per pack.	Qty. per pallet		
1	NX 43SE 5101	■				327	1 480		
	NX 43SE 5401	■				341	1 480	ECOGREEN ✓	
2	NX 43HG 5101		■			319	1 480		
	NX 43HG 5401		■			333	1 480	ECOGREEN ✓	
3	NX 43CR 5101			■		486	1 480		
	NX 43CR 5401			■		508	1 480	ECOGREEN ✓	
4	NX SEAL46 5113			2 x			500		
5	AT LOCK 8113		2 x				10		
6	LH TYT	Label holders for all sides					10		



1



2

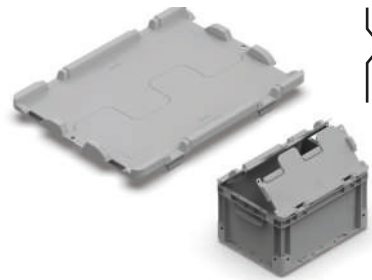

3



4











5



6

## DATASHEET

	Separate lid	400 x 300 mm
1	Pieces per pack.	 1
	Pieces per pallet / dims.	 480 / 1200x800x870 Hmm
	Hinged lid	400 x 300 mm
2	Pieces per pack.	 1
	Pieces per pallet / dims.	 480 / 1200x800x870 Hmm
	2-parts lid	400 x 300 mm
3	Pieces per pack.	 1
	Pieces per pallet / dims.	 480 / 1200x800x870 Hmm
	Disposable security seal	
4	Pieces per pack	 10
	Pair closing clips	
5	Pieces per pack	 500
	Label holders	
6	Pieces per pack	 10

iMilani srl reserves the right to alter the characteristics of products without notice. The values shown are nominal, with a +/- 1% tolerance for size, depending on the material, and a +/- 3% for weight.

	ARTICLE	WALLS			BOTTOM			HANDLES		GR.	PACKAGING		UNIT PRICE €
		Closed	Perforated	Picking short side	Closed	Perforated	Reinforced	Closed	Open		Qty. per pack.	Qty. per pallet	
	S NX 4327S 5101	■			■	■		■		1271	4	64	
	U NX 4327U 5101			■	■				■	1144	4	64	
	ARTICLE ON REQUEST												
	P NX 4327P 5401	■			■	■	■			1328	4	64	
	V NX 4327V 5401			■	■			■		1195	4	64	

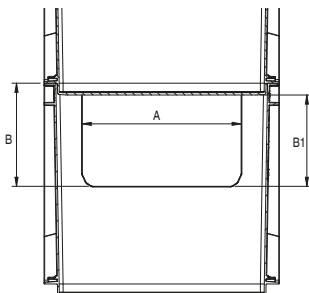
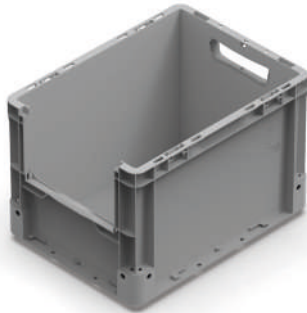
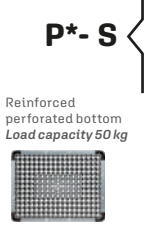

<b>A</b>	202
<b>B</b>	131
<b>B1</b>	116

\* **ECOGREEN** with closed moulded handle

◀◀ CONTINUED ON PREVIOUS PAGE

iMilani srl reserves the right to alter the characteristics of products without notice. The values shown are nominal, with a +/- 1% tolerance for size, depending on the material, and a +/- 3% for weight.

**P - S**

Stacked edge height	255 mm
Usable stacked height / with lid	240 mm / 244 mm
Usable internal dimensions	361 x 261 x 255 H mm
Volume	25,8 L
Pieces per package / pallet	4  64
Package dimensions	620 x 420 x 560 H mm
Pallet dimensions	1200 x 800 x 2205 H mm

**V - U**

Stacked edge height	255 mm
Usable stacked height / with lid	252 mm / 256 mm
Usable internal dimensions	361 x 261 x 267 H mm
Volume	24,6 L
Pieces per package / pallet	4  64
Package dimensions	620 x 420 x 560 H mm
Pallet dimensions	1200 x 800 x 2205 H mm







DATASHEET

**ARTICLES ON REQUEST**

Minimum order.....200 boxes  
Guaranteed shipping within.....60 days

# 400 x 300 mm

iMIBUBE

	ARTICLE	SEPARATE LID	HINGED LID	2 PARTS LID	GR.	PACKAGING		UNIT PRICE €	
						Qty. per pack.	Qty. per pallet		
1	NX 43SE 5101	■			327	1	480		
	NX 43SE 5401	■			341	1	480	ECOGREEN ✓	
2	NX 43HG 5101		■		319	1	480		
	NX 43HG 5401		■		333	1	480	ECOGREEN ✓	
3	NX 43CR 5101			■	486	1	480		
	NX 43CR 5401			■	508	1	480	ECOGREEN ✓	
4	NX SEAL46 5113			2 x		500			
5	AT LOCK 8113		2 x			10			
6	LH TYT	Label holders for all sides				10			
7	NX WC43276896	H270 Door				1			



1



2



3



4



5



6







7





## DATASHEET

	Separate lid	400 x 300 mm
1	Pieces per pack.	1
	Pieces per pallet / dims.	480 / 1200x800x870 Hmm
	Hinged lid	400 x 300 mm
2	Pieces per pack.	1
	Pieces per pallet / dims.	480 / 1200x800x870 Hmm
	2-parts lid	400 x 300 mm
3	Pieces per pack.	1
	Pieces per pallet / dims.	480 / 1200x800x870 Hmm
4	Disposable security seal	
	Pieces per pack	500
5	Pair closing clips	
	Pieces per pack	10
6	Label holders	
	Pieces per pack	10
7	H270 Door	
	Pieces per pack	1

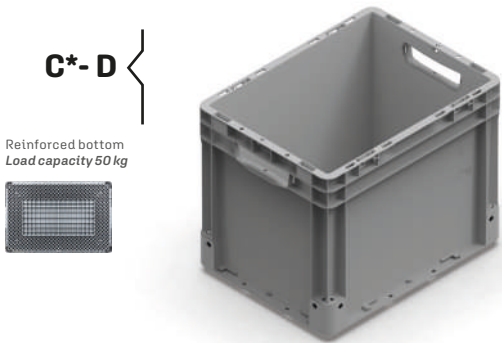
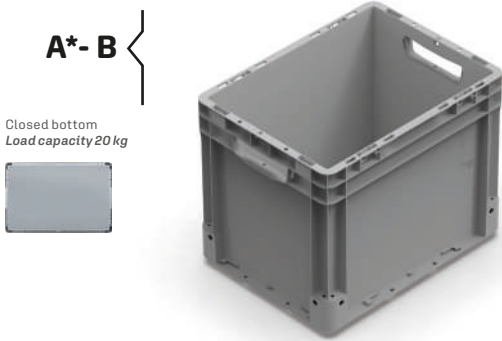
iMilani srl reserves the right to alter the characteristics of products without notice. The values shown are nominal, with a +/- 1% tolerance for size, depending on the material, and a +/- 3% for weight.

	ARTICLE	WALLS		BOTTOM			HANDLES		GR.	PACKAGING		UNIT PRICE €
		Closed	Perforated	Closed	Perforated	Reinforced	Closed	Open		Qty. per pack.	Qty. per pallet	
	B NX 4332B 5101	■		■			■		1362	2	56	
	A NX 4332A 5401	■		■			■		1423	2	56	
	D NX 4332D 5101	■				■	■		1577	2	56	
	ARTICLE ON REQUEST											
	C NX 4332C 5401	■				■	■		1648	2	56	



A - B	
Stacked edge height	305 mm
Usable stacked height / with lid	302 mm / 306 mm
Usable internal dimensions	361 x 261 x 317 H mm
Volume	30,6 L
Pieces per package / pallet	 2  56
Package dimensions	620 x 420 x 355 H mm
Pallet dimensions	1200 x 800 x 2300 H mm
C - D	
Stacked edge height	305 mm
Usable stacked height / with lid	290 mm / 294 mm
Usable internal dimensions	361 x 261 x 305 H mm
Volume	29,5 L
Pieces per package / pallet	 2  56
Package dimensions	620 x 420 x 355 H mm
Pallet dimensions	1200 x 800 x 2300 H mm

DATASHEET

\* **ECOGREEN** with closed moulded handle

CONTINUED ON NEXT PAGE



iMilani srl reserves the right to alter the characteristics of products without notice. The values shown are nominal, with a +/- 1% tolerance for size, depending on the material, and a +/- 3% for weight.













 **ARTICLES ON REQUEST**

Minimum order.....200 boxes  
Guaranteed shipping within.....60 days



# 400 x 300 mm

iMICUBE

	ARTICLE	SEPARATE LID	HINGED LID	2 PARTS LID	GR.	PACKAGING		UNIT PRICE €	
						Qty. per pack.	Qty. per pallet		
1	NX 43SE 5101	■				327	1 480		 
	NX 43SE 5401	■				341	1 480		
2	NX 43HG 5101		■			319	1 480		 
	NX 43HG 5401		■			333	1 480		
3	NX 43CR 5101			■		486	1 480		 
	NX 43CR 5401			■		508	1 480		
4	NX SEAL46 5113			2 x			500		 
5	AT LOCK 8113		2 x				10		 
6	LH TYT	Label holders for all sides					10		 



1



2



3



4











5



6

## DATASHEET

	Separate lid	400 x 300 mm
1	Pieces per pack.	 1
	Pieces per pallet / dims.	 480 / 1200x800x870 Hmm
	Hinged lid	400 x 300 mm
2	Pieces per pack.	 1
	Pieces per pallet / dims.	 480 / 1200x800x870 Hmm
	2-parts lid	400 x 300 mm
3	Pieces per pack.	 1
	Pieces per pallet / dims.	 480 / 1200x800x870 Hmm
	Disposable security seal	
4	Pieces per pack	 10
	Pair closing clips	
5	Pieces per pack	 500
	Label holders	
6	Pieces per pack	 10

iMilani srl reserves the right to alter the characteristics of products without notice. The values shown are nominal, with a +/- 1% tolerance for size, depending on the material, and a +/- 3% for weight.

	ARTICLE	WALLS			BOTTOM			HANDLES		GR.	PACKAGING		UNIT PRICE €
		Closed	Perforated	Picking short side	Closed	Perforated	Reinforced	Closed	Open		Qty. per pack.	Qty. per pallet	
	S NX 4332S 5101	■			■	■		■		1434	2	56	
	U NX 4332U 5101			■	■			■		1307	2	56	
	ARTICLE ON REQUEST												
	P NX 4332P 5401	■			■	■	■			1499	2	56	
	V NX 4332V 5401			■	■			■		1366	2	56	

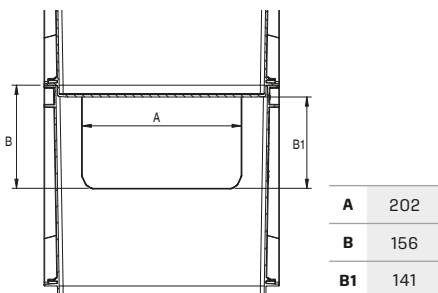
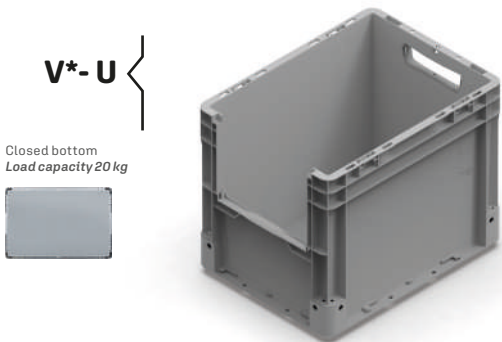
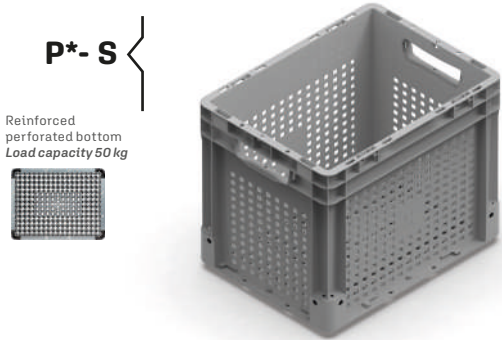

\* **ECOGREEN** with closed moulded handle

◀◀ CONTINUED ON PREVIOUS PAGE

iMilani srl reserves the right to alter the characteristics of products without notice. The values shown are nominal, with a +/- 1% tolerance for size, depending on the material, and a +/- 3% for weight.

**P - S**

Stacked edge height	305 mm
Usable stacked height / with lid	290 mm / 294 mm
Usable internal dimensions	361 x 261 x 305 H mm
Volume	29,5 L
Pieces per package / pallet	2  56
Package dimensions	620 x 420 x 355 H mm
Pallet dimensions	1200 x 800 x 2300 H mm

**V - U**

Stacked edge height	305 mm
Usable stacked height / with lid	302 mm / 306 mm
Usable internal dimensions	361 x 261 x 317 H mm
Volume	30,6 L
Pieces per package / pallet	2  56
Package dimensions	620 x 420 x 355 H mm
Pallet dimensions	1200 x 800 x 2300 H mm







DATASHEET

**ARTICLES ON REQUEST**

Minimum order.....200 boxes  
Guaranteed shipping within.....60 days

# 400 x 300 mm

iMICUBE

	ARTICLE	SEPARATE LID	HINGED LID	2 PARTS LID	GR.	PACKAGING		UNIT PRICE €	
						Qty. per pack.	Qty. per pallet		
1	NX 43SE 5101	■			327	1	480		
	NX 43SE 5401	■			341	1	480	ECOGREEN ✓	
2	NX 43HG 5101		■		319	1	480		
	NX 43HG 5401		■		333	1	480	ECOGREEN ✓	
3	NX 43CR 5101			■	486	1	480		
	NX 43CR 5401			■	508	1	480	ECOGREEN ✓	
4	NX SEAL46 5113			2 x		500			
5	AT LOCK 8113		2 x			10			
6	LH TYT	Label holders for all sides				10			
7	NX WC43326896	H320 Door				1			



1



2



3



4



5



6



7

## DATASHEET

	Separate lid	400 x 300 mm
1	Pieces per pack.	📦 1
	Pieces per pallet / dimens.	📦 480 / 1200x800x870 Hmm
	Hinged lid	400 x 300 mm
2	Pieces per pack.	📦 1
	Pieces per pallet / dimens.	📦 480 / 1200x800x870 Hmm
	2-parts lid	400 x 300 mm
3	Pieces per pack.	📦 1
	Pieces per pallet / dimens.	📦 480 / 1200x800x870 Hmm
4	Disposable security seal	
	Pieces per pack	📦 500
5	Pair closing clips	
	Pieces per pack	📦 10
6	Label holders	
	Pieces per pack	📦 10
7	H320 Door	
	Pieces per pack	📦 1

iMilani srl reserves the right to alter the characteristics of products without notice. The values shown are nominal, with a +/- 1% tolerance for size, depending on the material, and a +/- 3% for weight.

ARTICLE	1 PARTITION	2 PARTITIONS	4 PARTITIONS	GR.	PACKAGING		UNIT PRICE €
					Qty. per pack.	Qty. per pallet	
ECOGREEN ✓ 1 AT 43S1 5407	■			230	20	320	
ECOGREEN ✓ 2 AT 43S2 5407		■		246	20	320	
ECOGREEN ✓ 3 AT 43S4 5407			■	272	20	320	
4 AT LID4 6896	Transparent lid			118	20		

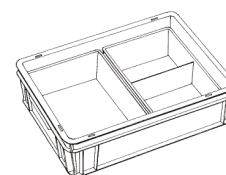

Subdivision with 1 and 2 compartments

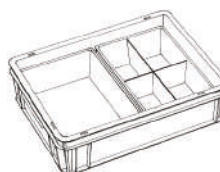
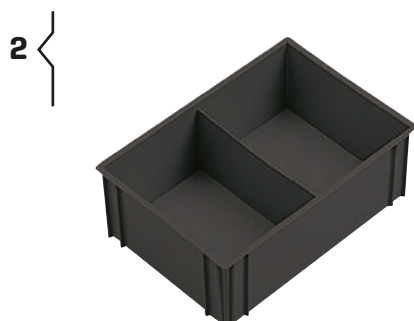

Subdivision with 1 and 4 compartments



Subdivision with 2 and 4 compartments

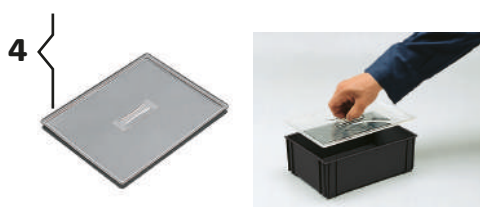
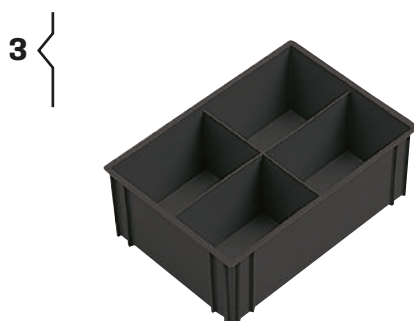

## 1

Partitioned box 1 partition	256 x 178 x 90 H mm
Pieces per pack / pallet	📦 20 🚚 320
Package dimensions	565 x 375 x 460 H mm
Pallet dimensions	1200 x 800 x 1990 H mm

## 2

Partitioned box 2 partitions	256 x 178 x 90 H mm
Pieces per pack / pallet	📦 20 🚚 320
Package dimensions	565 x 375 x 460 H mm
Pallet dimensions	1200 x 800 x 1990 H mm

## 3

Partitioned box 4 partitions	256 x 178 x 90 H mm
Pieces per pack / pallet	📦 20 🚚 320
Package dimensions	565 x 375 x 460 H mm
Pallet dimensions	1200 x 800 x 1990 H mm

## 4

Transparent polystyrene lid	
Pieces per pack	📦 20
Package dimensions	265 x 195 x 180 H mm

# 400 x 300 mm

	ARTICLE	H 45	H 70	H 90	H 120	H 180	H 220	PACKAGING		UNIT PRICE €
								Qty. per pack.	Qty. per pallet	
1	DI 25545246801	■						10		PS
	DI 35545246801	■						10		
2	DI 25570246801		■					10		PS
	DI 35570246801		■					10		
3	DI 25590246801			■				10		PS
	DI 35590246801			■				10		
4	DI 25512246801				■			10		PS
	DI 35512246801				■			10		
5	DI 25518246801					■		10		PS
	DI 35518246801					■		10		
6	DI 25522246801						■	10		PS
	DI 35522246801						■	10		
7	DI 43SHT 5101							10		PS

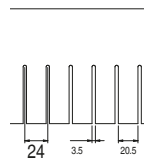

6801  
Pitch 24 mm

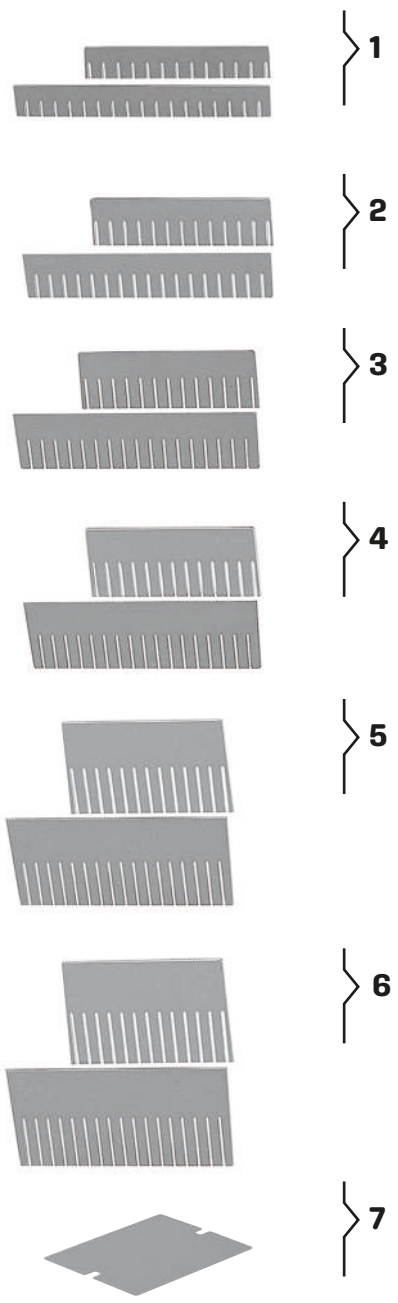

## DATASHEET

1	Comb divider 255 x 45 H mm per box 400 x 300 x 75 H mm	10 items
	Séparateur type peigne 355 x H 45 mm per box 400 x 300 x H 75 mm	10 items
2	Comb divider 255 x 70 H mm per box 400 x 300 x 120 H mm	10 items
	Comb divider 355 x 70 H mm per box 400 x 300 x 120 H mm	10 items
3	Comb divider 255 x 90 H mm per box 400 x 300 x 120 H mm	10 items
	Comb divider 355 x 90 H mm per box 400 x 300 x 120 H mm	10 items
4	Comb divider 255 x 120 H mm per box 400 x 300 x 170 H mm	10 items
	Comb divider 355 x 120 H mm per box 400 x 300 x 170 H mm	10 items
5	Comb divider 255 x 180 H mm per box 400 x 300 x 220 H mm	10 items
	Comb divider 355 x 180 H mm per box 400 x 300 x 220 H mm	10 items
6	Comb divider 255 x 220 H mm per box 400 x 300 x 270 H mm	10 items
	Comb divider 355 x 220 H mm per box 400 x 300 x 270 H mm	10 items
7	Intermediate partition shelf 355 x 255 mm	10 items

# 600 x 400 mm H 75 mm

	ARTICLE	WALLS		BOTTOM			HANDLES		GR.	PACKAGING		UNIT PRICE €
		Closed	Perforated	Closed	Perforated	Reinforced	Closed	Open		Qty. per pack.	Qty. per pallet	
♻️ ECO GREEN	A NX 6408A5101	■		■			■		1178	7	140	
	A NX 6408A5401	■		■			■		1231	7	140	
♻️	C NX 6408C5101	■				■	■		1699	7	140	
♻️	P NX 6408P5101		■			■	■		1604	7	140	
⚠️	ARTICLE ON REQUEST											
♻️	C NX 6408C5401	■				■	■		1775	7	140	
♻️	P NX 6408P5401		■			■	■		1676	7	140	

**A**

Closed bottom  
Load capacity 20 kg



**C**

Reinforced bottom  
Load capacity 50 kg



**P**

Reinforced perforated bottom  
Load capacity 50 kg

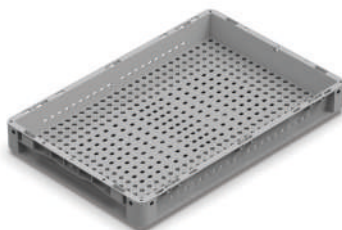
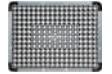

**A**

Stacked edge height	60 mm
Usable stacked height / with lid	57 mm / 61 mm
Usable internal dimensions	561 x 361 x 72 H mm
Volume	14,7 L
Pieces per package / pallet	📦 7 🚚 140
Package dimensions	620 x 420 x 470 H mm
Pallet dimensions	1200 x 800 x 2325 H mm

**C**

Stacked edge height	60 mm
Usable stacked height / with lid	45 mm / 49 mm
Usable internal dimensions	561 x 361 x 60 H mm
Volume	11,8 L
Pieces per package / pallet	📦 7 🚚 140
Package dimensions	620 x 420 x 470 H mm
Pallet dimensions	1200 x 800 x 2325 H mm

**P**







Stacked edge height	60 mm
Usable stacked height / with lid	45 mm / 49 mm
Usable internal dimensions	561 x 361 x 60 H mm
Volume	11,8 L
Pieces per package / pallet	📦 7 🚚 140
Package dimensions	620 x 420 x 470 H mm
Pallet dimensions	1200 x 800 x 2325 H mm

DATASHEET

iMilani srl reserves the right to alter the characteristics of products without notice. The values shown are nominal, with a +/- 1% tolerance for size, depending on the material, and a +/- 3% for weight.

⚠️ ARTICLES ON REQUEST

Minimum order.....200 boxes  
Guaranteed shipping within.....60 days

	ARTICLE	SEPARATE LID	HINGED LID	2 PARTS LID	GR.	PACKAGING		UNIT PRICE €	
						Qty. per pack.	Qty. per pallet		
1	NX 64SE 5101	■			751	1	176		
	NX 64SE 5401	■			785	1	176	ECOGREEN ✓	
2	NX 64HG 5101		■		710	1	176		
	NX 64HG 5401		■		742	1	176	ECOGREEN ✓	
3	NX 64CR 5101			■	1016	1	176		
	NX 64CR 5401			■	1062	1	176	ECOGREEN ✓	
4	NX 64CV 5101	Cover			845	1	176		
	NX 64CV 5401				883	1	176	ECOGREEN ✓	
5	NX SEAL46 5113			2 x		500			
6	AT LOCK 8113		2 x			10			



1



2



3



4



5



6

## DATASHEET

Separate lid	600 x 400 mm
1 Pieces per pack.	 1
Pieces per pallet / dims.	 176 / 1200x800x870 H mm
Hinged lid	600 x 400 mm
2 Pieces per pack.	 1
Pieces per pallet / dims.	 176 / 1200x800x870 H mm
2-parts lid	600 x 400 mm
3 Pieces per pack.	 1
Pieces per pallet / dims.	 176 / 1200x800x870 H mm
Cover	600 x 400 mm
4 Pieces per pack.	 1
Pieces per pallet / dims.	 176 / 1200x800x870 H mm
Disposable security seal	
5 Pieces per pack	 500
Pair closing clips	
6 Pieces per pack	 10

	ARTICLE	WALLS		BOTTOM			HANDLES		GR.	PACKAGING		UNIT PRICE €
		Closed	Perforated	Closed	Perforated	Reinforced	Closed	Open		Qty. per pack.	Qty. per pallet	
 ECOGREEN	A NX 6412A 5101	■		■			■		1441	4	80	
	A NX 6412A 5401	■		■			■		1506	4	80	
	C NX 6412C 5101	■				■	■		1961	4	80	
	P NX 6412P 5101		■		■	■	■		1828	4	80	
⚠ ARTICLE ON REQUEST												
ECOGREEN	C NX 6412C 5401	■				■	■		2049	4	80	
ECOGREEN	P NX 6412P 5401		■		■	■	■		1910	4	80	

**A**

Closed bottom  
Load capacity 20 kg



**C**

Reinforced bottom  
Load capacity 50 kg

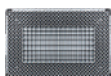

**P**

Reinforced perforated bottom  
Load capacity 50 kg



**A**

Stacked edge height	105 mm
Usable stacked height / with lid	102 mm / 106 mm
Usable internal dimensions	561 x 361 x 117 H mm
Volume	23,9 L
Pieces per package / pallet	📦 4 🚚 80
Package dimensions	620 x 420 x 470 H mm
Pallet dimensions	1200 x 800 x 2370 H mm

**C**







Stacked edge height	105 mm
Usable stacked height / with lid	90 mm / 94 mm
Usable internal dimensions	561 x 361 x 105 H mm
Volume	21,1 L
Pieces per package / pallet	📦 4 🚚 80
Package dimensions	620 x 420 x 470 H mm
Pallet dimensions	1200 x 800 x 2370 H mm

**P**

Stacked edge height	105 mm
Usable stacked height / with lid	90 mm / 94 mm
Usable internal dimensions	561 x 361 x 105 H mm
Volume	21,1 L
Pieces per package / pallet	📦 4 🚚 80
Package dimensions	620 x 420 x 470 H mm
Pallet dimensions	1200 x 800 x 2370 H mm

DATASHEET



	ARTICLE	SEPARATE LID	HINGED LID	2 PARTS LID	GR.	PACKAGING		UNIT PRICE €	
						Qty. per pack.	Qty. per pallet		
1	NX 64SE 5101	■			751	1	176		
	NX 64SE 5401	■			785	1	176	ECOGREEN ✓	
2	NX 64HG 5101		■		710	1	176		
	NX 64HG 5401		■		742	1	176	ECOGREEN ✓	
3	NX 64CR 5101			■	1016	1	176		
	NX 64CR 5401			■	1062	1	176	ECOGREEN ✓	
4	NX 64CV 5101	Cover			845	1	176		
	NX 64CV 5401				883	1	176	ECOGREEN ✓	
5	NX SEAL46 5113			2 x		500			
6	AT LOCK 8113		2 x			10			
7	LH TYT	Label holders for all sides				10			



1



2



3



4



5



6



7

## DATASHEET

Separate lid	600 x 400 mm
1 Pieces per pack.	📦 1
Pieces per pallet / dimens.	📦 176 / 1200x800x870H mm
Hinged lid	600 x 400 mm
2 Pieces per pack.	📦 1
Pieces per pallet / dtmens.	📦 176 / 1200x800x870H mm
2-parts lid	600 x 400 mm
3 Pieces per pack.	📦 1
Pieces per pallet / dimens.	📦 176 / 1200x800x870H mm
Cover	600 x 400 mm
4 Pieces per pack.	📦 1
Pieces per pallet / dimens.	📦 176 / 1200x800x870H mm
Disposable security seal	
5 Pieces per pack	📦 500
Pair closing clips	
6 Pieces per pack	📦 10
Label holders	
7 Pieces per pack	📦 10

	ARTICLE	WALLS		BOTTOM			HANDLES		GR.	PACKAGING		UNIT PRICE €
		Closed	Perforated	Closed	Perforated	Reinforced	Closed	Open		Qty. per pack.	Qty. per pallet	
	B NX 6417B 5101	■		■			■		1680	3	60	
	A NX 6417A 5401	■		■			■		1756	3	60	
	D NX 6417D 5101	■				■		■	2191	3	60	
	S NX 6417S 5101		■		■	■		■	2022	3	60	
	ARTICLE ON REQUEST											
	C NX 6417C 5401	■				■	■		2290	3	60	
	P NX 6417P 5401		■		■	■	■		2113	3	60	

Closed bottom  
Load capacity 20 kg



A\* - B

Reinforced bottom  
Load capacity 50 kg



C\* - D

Reinforced perforated bottom  
Load capacity 50 kg



P\* - S

### A - B

Stacked edge height	155 mm
Usable stacked height / with lid	152 mm / 156 mm
Usable internal dimensions	561 x 361 x 167 H mm
Volume	34,2 L
Pieces per package / pallet	3  60
Package dimensions	620 x 420 x 515 H mm
Pallet dimensions	1200 x 800 x 2490 H mm

### C - D

Stacked edge height	155 mm
Usable stacked height / with lid	140 mm / 144 mm
Usable internal dimensions	561 x 361 x 155 H mm
Volume	31,4 L
Pieces per package / pallet	3  60
Package dimensions	620 x 420 x 515 H mm
Pallet dimensions	1200 x 800 x 2490 H mm

### P - S

Stacked edge height	155 mm
Usable stacked height / with lid	140 mm / 144 mm
Usable internal dimensions	561 x 361 x 155 H mm
Volume	31,4 L
Pieces per package / pallet	3  60
Package dimensions	620 x 420 x 515 H mm
Pallet dimensions	1200 x 800 x 2490 H mm







DATASHEET

\* **ECOGREEN** with closed moulded handle

iMilani srl reserves the right to alter the characteristics of products without notice. The values shown are nominal, with a +/- 1% tolerance for size, depending on the material, and a +/- 3% for weight.

**ARTICLES ON REQUEST**

Minimum order.....200 boxes  
Guaranteed shipping within.....60 days

	ARTICLE	SEPARATE LID	HINGED LID	2 PARTS LID	GR.	PACKAGING		UNIT PRICE €	
						Qty. per pack.	Qty. per pallet		
1	NX 64SE 5101	■			751	1	176		
	NX 64SE 5401	■			785	1	176	ECOGREEN ✓	
2	NX 64HG 5101		■		710	1	176		
	NX 64HG 5401		■		742	1	176	ECOGREEN ✓	
3	NX 64CR 5101			■	1016	1	176		
	NX 64CR 5401			■	1062	1	176	ECOGREEN ✓	
4	NX 64CV 5101	Cover			845	1	176		
	NX 64CV 5401				883	1	176	ECOGREEN ✓	
5	NX SEAL46 5113			2 x		500			
6	AT LOCK 8113		2 x			10			
7	LH TYT	Label holders for all sides				10			



1



2



3



4



5



6

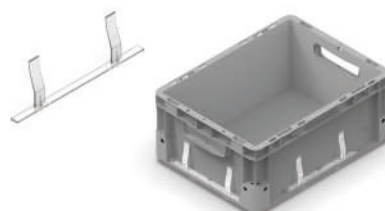

7

## DATASHEET

Separate lid	600 x 400 mm
1 Pieces per pack.	📦 1
Pieces per pallet / dimens.	📦 176 / 1200x800x870H mm
Hinged lid	600 x 400 mm
2 Pieces per pack.	📦 1
Pieces per pallet / dtmens.	📦 176 / 1200x800x870H mm
2-parts lid	600 x 400 mm
3 Pieces per pack.	📦 1
Pieces per pallet / dimens.	📦 176 / 1200x800x870H mm
Cover	600 x 400 mm
4 Pieces per pack.	📦 1
Pieces per pallet / dimens.	📦 176 / 1200x800x870H mm
Disposable security seal	
5 Pieces per pack	📦 500
Pair closing clips	
6 Pieces per pack	📦 10
Label holders	
7 Pieces per pack	📦 10

	ARTICLE	WALLS		BOTTOM			HANDLES		GR.	PACKAGING		UNIT PRICE €
		Closed	Perforated	Closed	Perforated	Reinforced	Closed	Open		Qty. per pack.	Qty. per pallet	
	B NX 6422B 5101	■		■			■		1901	2	40	
	A NX 6422A 5401	■		■			■		1987	2	40	
	D NX 6422D 5101	■				■	■		2421	2	40	
	ARTICLE ON REQUEST											
	C NX 6422C 5401	■				■	■		2530	2	40	

Closed bottom  
Load capacity 20 kg



Reinforced bottom  
Load capacity 50 kg



### A - B

Stacked edge height	205 mm
Usable stacked height / with lid	202 mm / 206 mm
Usable internal dimensions	561 x 361 x 217 H mm
Volume	44,5 L
Pieces per package / pallet	2  40
Package dimensions	620 x 420 x 460 H mm
Pallet dimensions	1200 x 800 x 2215 H mm

### C - D

Stacked edge height	205 mm
Usable stacked height / with lid	190 mm / 194 mm
Usable internal dimensions	561 x 361 x 205 H mm
Volume	41,7 L
Pieces per package / pallet	2  40
Package dimensions	620 x 420 x 460 H mm
Pallet dimensions	1200 x 800 x 2215 H mm

DATASHEET

\* **ECOGREEN** with closed moulded handle







CONTINUED ON NEXT PAGE



iMilani srl reserves the right to alter the characteristics of products without notice. The values shown are nominal, with a +/- 1% tolerance for size, depending on the material, and a +/- 3% for weight.

**ARTICLES ON REQUEST**

Minimum order.....200 boxes  
Guaranteed shipping within.....60 days

	ARTICLE	SEPARATE LID	HINGED LID	2 PARTS LID	GR.	PACKAGING		UNIT PRICE €	
						Qty. per pack.	Qty. per pallet		
1	NX 64SE 5101	■			751	1	176		
	NX 64SE 5401	■			785	1	176	ECOGREEN ✓	
2	NX 64HG 5101		■		710	1	176		
	NX 64HG 5401		■		742	1	176	ECOGREEN ✓	
3	NX 64CR 5101			■	1016	1	176		
	NX 64CR 5401			■	1062	1	176	ECOGREEN ✓	
4	NX 64CV 5101	Cover			845	1	176		
	NX 64CV 5401				883	1	176	ECOGREEN ✓	
5	NX SEAL46 5113			2 x		500			
6	AT LOCK 8113		2 x			10			
7	LH TYT	Label holders for all sides				10			



1



2



3



4



5



6

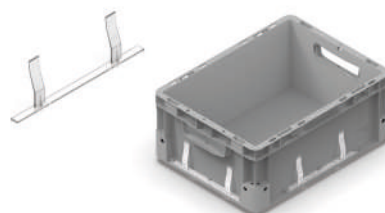

7

## DATASHEET

Separate lid	600 x 400 mm
1 Pieces per pack.	📦 1
Pieces per pallet / dimens.	📦 176 / 1200x800x870H mm
Hinged lid	600 x 400 mm
2 Pieces per pack.	📦 1
Pieces per pallet / dtmens.	📦 176 / 1200x800x870H mm
2-parts lid	600 x 400 mm
3 Pieces per pack.	📦 1
Pieces per pallet / dimens.	📦 176 / 1200x800x870H mm
Cover	600 x 400 mm
4 Pieces per pack.	📦 1
Pieces per pallet / dimens.	📦 176 / 1200x800x870H mm
Disposable security seal	
5 Pieces per pack	📦 500
Pair closing clips	
6 Pieces per pack	📦 10
Label holders	
7 Pieces per pack	📦 10

	ARTICLE	WALLS			BOTTOM			HANDLES		GR.	PACKAGING		UNIT PRICE €
		Closed	Perforated	Picking short side	Closed	Perforated	Reinforced	Closed	Open		Qty. per pack.	Qty. per pallet	
	S NX 6422S 5101	■				■	■	■		2164	2	40	
	U NX 6422U 5101			■	■				■	1838	2	40	
	ARTICLE ON REQUEST												
	P NX 6422P 5401	■				■	■	■		2261	2	40	
	V NX 6422V 5401			■	■			■		1921	2	40	

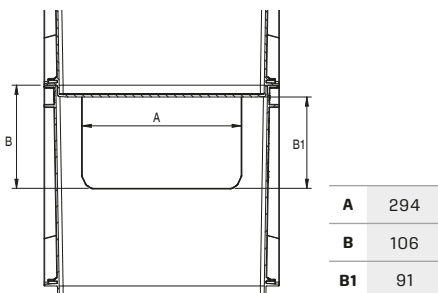
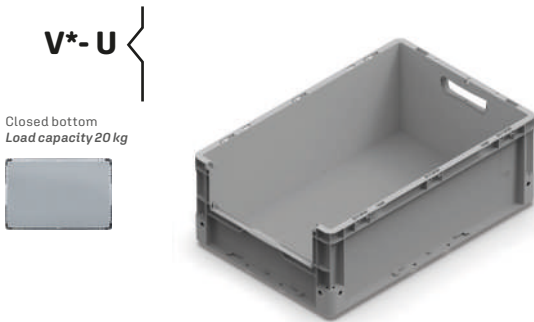
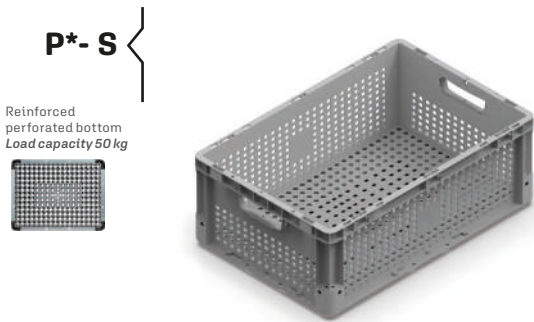

\* **ECOGREEN** with closed moulded handle

◀◀ CONTINUED ON PREVIOUS PAGE

iMilani srl reserves the right to alter the characteristics of products without notice. The values shown are nominal, with a +/- 1% tolerance for size, depending on the material, and a +/- 3% for weight.

### P-S

Stacked edge height	205 mm
Usable stacked height / with lid	190 mm / 194 mm
Usable internal dimensions	561 x 361 x 205 H mm
Volume	41,7 L
Pieces per package / pallet	2  40
Package dimensions	620 x 420 x 460 H mm
Pallet dimensions	1200 x 800 x 2215 H mm

### V-U

Stacked edge height	205 mm
Usable stacked height / with lid	202 mm / 206 mm
Usable internal dimensions	561 x 361 x 217 H mm
Volume	44,5 L
Pieces per package / pallet	2  40
Package dimensions	620 x 420 x 460 H mm
Pallet dimensions	1200 x 800 x 2215 H mm

DATASHEET

**ARTICLES ON REQUEST**

Minimum order.....200 boxes  
Guaranteed shipping within.....60 days

# 600 x 400 mm

iMICUBE

	ARTICLE	SEPARATE LID	HINGED LID	2 PARTS LID	GR.	PACKAGING		UNIT PRICE €	
						Qty. per pack.	Qty. per pallet		
1	NX 64SE 5101	■			751	1	176		
	NX 64SE 5401	■			785	1	176	ECOGREEN ✓	
2	NX 64HG 5101		■		710	1	176		
	NX 64HG 5401		■		742	1	176	ECOGREEN ✓	
3	NX 64CR 5101			■	1016	1	176		
	NX 64CR 5401			■	1062	1	176	ECOGREEN ✓	
4	NX 64CV 5101	Cover			845	1	176		
	NX 64CV 5401	Cover			883	1	176	ECOGREEN ✓	
5	NX SEAL46 5113			2 x			500		
6	AT LOCK 8113		2 x				10		
7	LH TYT	Label holders for all sides					10		
8	NX WC64226896	Door for H220					10		



1



2

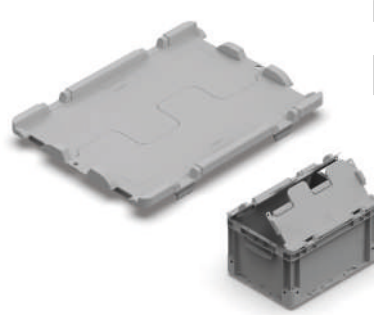

3



4



5



6



7



8

## DATASHEET

Separate lid	600 x 400 mm
1 Pieces per pack.	1
Pieces per pallet / dims.	176 / 1200x800x870H mm
Hinged lid	600 x 400 mm
2 Pieces per pack.	1
Pieces per pallet / dims.	176 / 1200x800x870H mm
2-parts lid	600 x 400 mm
3 Pieces per pack.	1
Pieces per pallet / dims.	176 / 1200x800x870H mm
Cover	600 x 400 mm
4 Pieces per pack.	1
Pieces per pallet / dims.	176 / 1200x800x870H mm
Disposable security seal	
5 Pieces per pack	500
Pair closing clips	
6 Pieces per pack	10
Label holders	
7 Pieces per pack	10
Door for H220	
8 Pieces per pack	1

iMilani srl reserves the right to alter the characteristics of products without notice. The values shown are nominal, with a +/- 1% tolerance for size, depending on the material, and a +/- 3% for weight.

	ARTICLE	WALLS		BOTTOM			HANDLES		GR.	PACKAGING		UNIT PRICE €
		Closed	Perforated	Closed	Perforated	Reinforced	Closed	Open		Qty. per pack.	Qty. per pallet	
♻️ B ECOGREEN	NX 6427B 5101	■		■			■		2133	2	32	
	NX 6427B 5401	■		■			■		2229	2	32	
♻️ D	NX 6427D 5101	■				■		■	2654	2	32	
⚠️	ARTICLE ON REQUEST											
♻️ D	NX 6427D 5401	■				■	■		2773	2	32	

**B**

Closed bottom  
Load capacity 20 kg



**D**

Reinforced bottom  
Load capacity 50 kg



**B**

Stacked edge height	255 mm
Usable stacked height / with lid	252 mm / 256 mm
Usable internal dimensions	561 x 361 x 267 H mm
Volume	54,8 L
Pieces per package / pallet	📦 2 🚚 32
Package dimensions	620 x 420 x 560 H mm
Pallet dimensions	1200 x 800 x 2205 H mm

**D**

Stacked edge height	255 mm
Usable stacked height / with lid	240 mm / 244 mm
Usable internal dimensions	561 x 361 x 255 H mm
Volume	52 L
Pieces per package / pallet	📦 2 🚚 32
Package dimensions	620 x 420 x 560 H mm
Pallet dimensions	1200 x 800 x 2205 H mm

DATASHEET

CONTINUED ON NEXT PAGE

















iMilani srl reserves the right to alter the characteristics of products without notice. The values shown are nominal, with a +/- 1% tolerance for size, depending on the material, and a +/- 3% for weight.

⚠️ ARTICLES ON REQUEST

Minimum order.....200 boxes  
Guaranteed shipping within.....60 days



	ARTICLE	SEPARATE LID	HINGED LID	2 PARTS LID	GR.	PACKAGING		UNIT PRICE €	
						Qty. per pack.	Qty. per pallet		
1	NX 64SE 5101	■			751	1	176		 
	NX 64SE 5401	■			785	1	176		
2	NX 64HG 5101		■		710	1	176		 
	NX 64HG 5401		■		742	1	176		
3	NX 64CR 5101			■	1016	1	176		 
	NX 64CR 5401			■	1062	1	176		
4	NX 64CV 5101	Cover			845	1	176		 
	NX 64CV 5401				883	1	176		
5	NX SEAL46 5113			2 x		500		 	
6	AT LOCK 8113		2 x			10		 	
7	LH TYT	Label holders for all sides				10		 	



1



2



3



4



5



6



7

## DATASHEET

Separate lid	600 x 400 mm
1 Pieces per pack.	📦 1
Pieces per pallet / dimens.	📦 176 / 1200x800x870H mm
Hinged lid	600 x 400 mm
2 Pieces per pack.	📦 1
Pieces per pallet / dtmens.	📦 176 / 1200x800x870H mm
2-parts lid	600 x 400 mm
3 Pieces per pack.	📦 1
Pieces per pallet / dimens.	📦 176 / 1200x800x870H mm
Cover	600 x 400 mm
4 Pieces per pack.	📦 1
Pieces per pallet / dimens.	📦 176 / 1200x800x870H mm
Disposable security seal	
5 Pieces per pack	📦 500
Pair closing clips	
6 Pieces per pack	📦 10
Label holders	
7 Pieces per pack	📦 10

	ARTICLE	WALLS			BOTTOM			HANDLES		GR.	PACKAGING		UNIT PRICE €
		Closed	Perforated	Picking short side	Closed	Perforated	Reinforced	Closed	Open		Qty. per pack.	Qty. per pallet	
	S NX 6427S 5101	■			■	■		■		2394	2	32	
	U NX 6427U 5101			■	■			■		2056	2	32	
	ARTICLE ON REQUEST												
	S NX 6427S 5401	■			■	■	■			2502	2	32	
	U NX 6427U 5401			■	■			■		2149	2	32	

Reinforced perforated bottom  
Load capacity 50 kg



S



Closed bottom  
Load capacity 20 kg



U

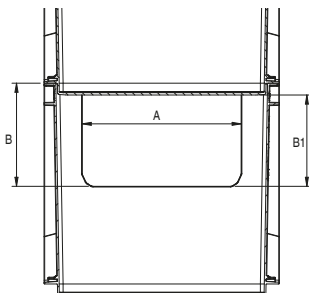

<b>A</b>	294
<b>B</b>	131
<b>B1</b>	116

S	
Stacked edge height	255 mm
Usable stacked height / with lid	240 mm / 244 mm
Usable internal dimensions	561 x 361 x 255 H mm
Volume	52 L
Pieces per package / pallet	2  32
Package dimensions	620 x 420 x 560 H mm
Pallet dimensions	1200 x 800 x 2205 H mm
U	
Stacked edge height	255 mm
Usable stacked height / with lid	252 mm / 256 mm
Usable internal dimensions	561 x 361 x 267 H mm
Volume	54,8 L
Pieces per package / pallet	2  32
Package dimensions	620 x 420 x 560 H mm
Pallet dimensions	1200 x 800 x 2205 H mm

DATASHEET

« CONTINUED ON PREVIOUS PAGE

iMilani srl reserves the right to alter the characteristics of products without notice. The values shown are nominal, with a +/- 1% tolerance for size, depending on the material, and a +/- 3% for weight.

ARTICLES ON REQUEST

Minimum order.....200 boxes  
Guaranteed shipping within.....60 days

# 600 x 400 mm

iMICUBE

	ARTICLE	SEPARATE LID	HINGED LID	2 PARTS LID	GR.	PACKAGING		UNIT PRICE €	
						Qty. per pack.	Qty. per pallet		
1	NX 64SE 5101	■			751	1	176		
	NX 64SE 5401	■			785	1	176	ECOGREEN ✓	
2	NX 64HG 5101		■		710	1	176		
	NX 64HG 5401		■		742	1	176	ECOGREEN ✓	
3	NX 64CR 5101			■	1016	1	176		
	NX 64CR 5401			■	1062	1	176	ECOGREEN ✓	
4	NX 64CV 5101	Cover			845	1	176		
	NX 64CV 5401				883	1	176	ECOGREEN ✓	
5	NX SEAL46 5113			2 x			500		
6	AT LOCK 8113		2 x				10		
7	LH TYT	Label holders for all sides					10		
8	NX WC64276896	Door for H270					1		



1



2

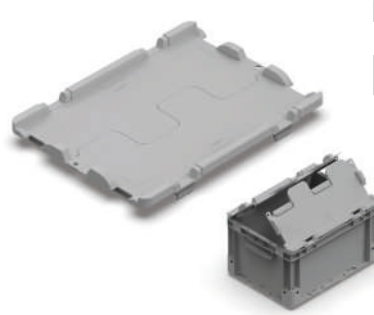

3



4



5



6



7



8

## DATASHEET

Separate lid	600 x 400 mm
1 Pieces per pack.	1
Pieces per pallet / dims.	176 / 1200x800x870H mm
Hinged lid	600 x 400 mm
2 Pieces per pack.	1
Pieces per pallet / dims.	176 / 1200x800x870H mm
2-parts lid	600 x 400 mm
3 Pieces per pack.	1
Pieces per pallet / dims.	176 / 1200x800x870H mm
Cover	600 x 400 mm
4 Pieces per pack.	1
Pieces per pallet / dims.	176 / 1200x800x870H mm
Disposable security seal	
5 Pieces per pack	500
Pair closing clips	
6 Pieces per pack	10
Label holders	
7 Pieces per pack	10
Door for H270	
8 Pieces per pack	1

iMilani srl reserves the right to alter the characteristics of products without notice. The values shown are nominal, with a +/- 1% tolerance for size, depending on the material, and a +/- 3% for weight.

	ARTICLE	WALLS		BOTTOM			HANDLES		GR.	PACKAGING		UNIT PRICE €
		Closed	Perforated	Closed	Perforated	Reinforced	Closed	Open		Qty. per pack.	Qty. per pallet	
 B ECOGREEN	NX 6432B 5101	■		■			■		2423	3	40	
	NX 6432B 5401	■		■			■		2532	3	40	
 D	NX 6432D 5101	■				■		■	2944	3	40	
	⚠ ARTICLE ON REQUEST											
ECOGREEN	NX 6432D 5401	■				■	■		3076	3	40	

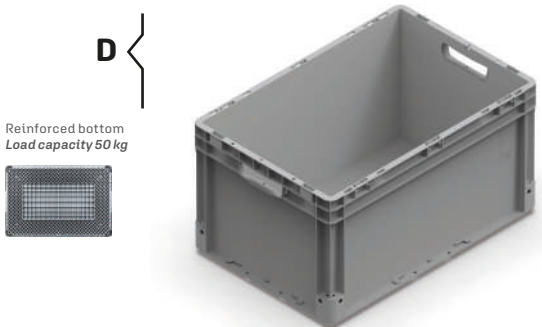
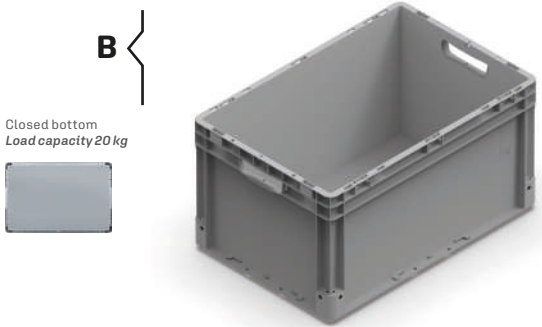

B	
Stacked edge height	305 mm
Usable stacked height / with lid	302 mm / 306 mm
Usable internal dimensions	561 x 361 x 317 H mm
Volume	65,1 L
Pieces per package / pallet	3  40
Package dimensions	620 x 420 x 675 H mm
Pallet dimensions	1200 x 800 x 2390 H mm
D	
Stacked edge height	305 mm
Usable stacked height / with lid	290 mm / 294 mm
Usable internal dimensions	561 x 361 x 305 H mm
Volume	62,2 L
Pieces per package / pallet	3  40
Package dimensions	620 x 420 x 675 H mm
Pallet dimensions	1200 x 800 x 2390 H mm

DATASHEET

CONTINUED ON NEXT PAGE >>

iMilani srl reserves the right to alter the characteristics of products without notice. The values shown are nominal, with a +/- 1% tolerance for size, depending on the material, and a +/- 3% for weight.

⚠ ARTICLES ON REQUEST  
 Minimum order.....200 boxes  
 Guaranteed shipping within.....60 days

	ARTICLE	SEPARATE LID	HINGED LID	2 PARTS LID	GR.	PACKAGING		UNIT PRICE €	
						Qty. per pack.	Qty. per pallet		
1	NX 64SE 5101	■			751	1	176		
	NX 64SE 5401	■			785	1	176	ECOGREEN ✓	
2	NX 64HG 5101		■		710	1	176		
	NX 64HG 5401		■		742	1	176	ECOGREEN ✓	
3	NX 64CR 5101			■	1016	1	176		
	NX 64CR 5401			■	1062	1	176	ECOGREEN ✓	
4	NX 64CV 5101	Cover			845	1	176		
	NX 64CV 5401				883	1	176	ECOGREEN ✓	
5	NX SEAL46 5113			2 x			500		
6	AT LOCK 8113		2 x				10		
7	LH TYT	Label holders for all sides						10	



1



2



3



4



5



6



7

## DATASHEET

Separate lid	600 x 400 mm
1 Pieces per pack.	📦 1
Pieces per pallet / dimens.	📦 176 / 1200x800x870H mm
Hinged lid	600 x 400 mm
2 Pieces per pack.	📦 1
Pieces per pallet / dtmens.	📦 176 / 1200x800x870H mm
2-parts lid	600 x 400 mm
3 Pieces per pack.	📦 1
Pieces per pallet / dimens.	📦 176 / 1200x800x870H mm
Cover	600 x 400 mm
4 Pieces per pack.	📦 1
Pieces per pallet / dimens.	📦 176 / 1200x800x870H mm
Disposable security seal	
5 Pieces per pack	📦 500
Pair closing clips	
6 Pieces per pack	📦 10
Label holders	
7 Pieces per pack	📦 10

	ARTICLE	WALLS			BOTTOM			HANDLES		GR.	PACKAGING		UNIT PRICE €
		Closed	Perforated	Picking short side	Closed	Perforated	Reinforced	Closed	Open		Qty. per pack.	Qty. per pallet	
	S NX 6432S 5101	■			■	■		■		2655	3	40	
	U NX 6432U 5101			■	■			■		2323	3	40	
	ARTICLE ON REQUEST												
	S NX 6432S 5401	■			■	■		■		2774	3	40	
	U NX 6432U 5401			■	■			■		2428	3	40	

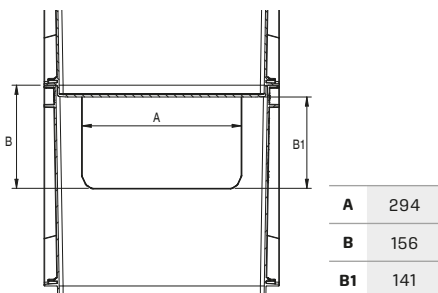
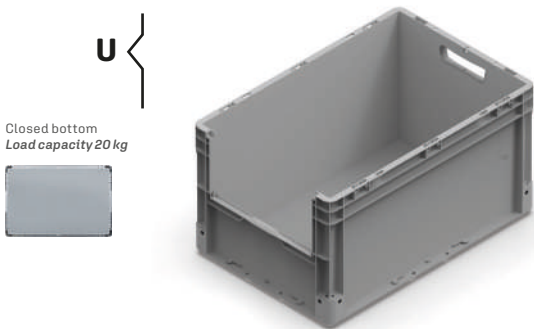
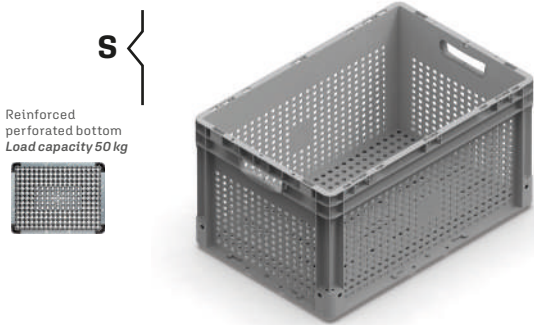

S	
Stacked edge height	305 mm
Usable stacked height / with lid	290 mm / 294 mm
Usable internal dimensions	561 x 361 x 305 H mm
Volume	62,2 L
Pieces per package / pallet	3  40
Package dimensions	620 x 420 x 675 H mm
Pallet dimensions	1200 x 800 x 2390 H mm
U	
Stacked edge height	305 mm
Usable stacked height / with lid	302 mm / 306 mm
Usable internal dimensions	561 x 361 x 317 H mm
Volume	65,1 L
Pieces per package / pallet	3  40
Package dimensions	620 x 420 x 675 H mm
Pallet dimensions	1200 x 800 x 2390 H mm

DATASHEET

« CONTINUED ON PREVIOUS PAGE

iMilani srl reserves the right to alter the characteristics of products without notice. The values shown are nominal, with a +/- 1% tolerance for size, depending on the material, and a +/- 3% for weight.

ARTICLES ON REQUEST

Minimum order.....200 boxes  
Guaranteed shipping within.....60 days

# 600 x 400 mm

iMICUBE

	ARTICLE	SEPARATE LID	HINGED LID	2 PARTS LID	GR.	PACKAGING		UNIT PRICE €	
						Qty. per pack.	Qty. per pallet		
1	NX 64SE 5101	■			751	1	176		
	NX 64SE 5401	■			785	1	176	ECOGREEN ✓	
2	NX 64HG 5101		■		710	1	176		
	NX 64HG 5401		■		742	1	176	ECOGREEN ✓	
3	NX 64CR 5101			■	1016	1	176		
	NX 64CR 5401			■	1062	1	176	ECOGREEN ✓	
4	NX 64CV 5101	Cover			845	1	176		
	NX 64CV 5401				883	1	176	ECOGREEN ✓	
5	NX SEAL46 5113			2 x			500		
6	AT LOCK 8113		2 x				10		
7	LH TYT	Label holders for all sides					10		
8	NX WC64326896	Door for H 320					1		



1



2

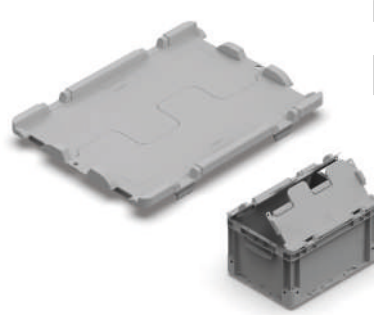

3



4



5



6



7



8

## DATASHEET

Separate lid	600 x 400 mm
1 Pieces per pack.	1
Pieces per pallet / dims.	176 / 1200x800x870H mm
Hinged lid	600 x 400 mm
2 Pieces per pack.	1
Pieces per pallet / dims.	176 / 1200x800x870H mm
2-parts lid	600 x 400 mm
3 Pieces per pack.	1
Pieces per pallet / dims.	176 / 1200x800x870H mm
Cover	600 x 400 mm
4 Pieces per pack.	1
Pieces per pallet / dims.	176 / 1200x800x870H mm
Disposable security seal	
5 Pieces per pack	500
Pair closing clips	
6 Pieces per pack	10
Label holders	
7 Pieces per pack	10
Door for H 320	
8 Pieces per pack	1

iMilani srl reserves the right to alter the characteristics of products without notice. The values shown are nominal, with a +/- 1% tolerance for size, depending on the material, and a +/- 3% for weight.

	ARTICLE	WALLS		BOTTOM			HANDLES		GR.	PACKAGING		UNIT PRICE €
		Closed	Perforated	Closed	Perforated	Reinforced	Closed	Open		Qty. per pack.	Qty. per pallet	
♻️ ECOGREEN	B NX 6442B 5101	■		■				■	2886	1	20	
	B NX 6442B 5401	■		■				■	3016	1	20	
♻️ PP	D NX 6442D 5101	■				■		■	3407	1	20	
⚠️	ARTICLE ON REQUEST											
♻️ ECOGREEN	D NX 6442D 5401	■				■	■		3560	1	20	

**B**

Closed bottom  
Load capacity 20 kg



**D**

Reinforced bottom  
Load capacity 50 kg



**B**

Stacked edge height	405 mm
Usable stacked height / with lid	402 mm / 406 mm
Usable internal dimensions	561 x 361 x 417 H mm
Volume	85,6 L
Pieces per package / pallet	📦 1 🚚 20
Package dimensions	620 x 420 x 455 H mm
Pallet dimensions	1200 x 800 x 2190 H mm

**D**

Stacked edge height	405 mm
Usable stacked height / with lid	390 mm / 394 mm
Usable internal dimensions	561 x 361 x 405 H mm
Volume	82,8 L
Pieces per package / pallet	📦 1 🚚 20
Package dimensions	620 x 420 x 455 H mm
Pallet dimensions	1200 x 800 x 2190 H mm

DATASHEET

CONTINUED ON NEXT PAGE









iMilani srl reserves the right to alter the characteristics of products without notice. The values shown are nominal, with a +/- 1% tolerance for size, depending on the material, and a +/- 3% for weight.

⚠️ **ARTICLES ON REQUEST**

Minimum order.....200 boxes  
Guaranteed shipping within.....60 days



	ARTICLE	SEPARATE LID	HINGED LID	2 PARTS LID	GR.	PACKAGING		UNIT PRICE €	
						Qty. per pack.	Qty. per pallet		
1	NX 64SE 5101	■			751	1	176		
	NX 64SE 5401	■			785	1	176	ECOGREEN ✓	
2	NX 64HG 5101		■		710	1	176		
	NX 64HG 5401		■		742	1	176	ECOGREEN ✓	
3	NX 64CR 5101			■	1016	1	176		
	NX 64CR 5401			■	1062	1	176	ECOGREEN ✓	
4	NX 64CV 5101	Cover			845	1	176		
	NX 64CV 5401				883	1	176	ECOGREEN ✓	
5	NX SEAL46 5113			2 x		500			
6	AT LOCK 8113		2 x			10			
7	LH TYT	Label holders for all sides				10			



1



2



3



4



5



6

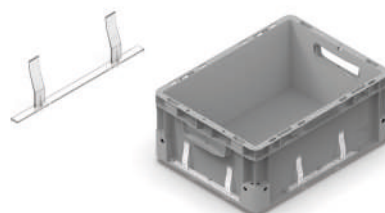

7

## DATASHEET

Separate lid	600 x 400 mm
1 Pieces per pack.	📦 1
Pieces per pallet / dimens.	📦 176 / 1200x800x870H mm
Hinged lid	600 x 400 mm
2 Pieces per pack.	📦 1
Pieces per pallet / dtmens.	📦 176 / 1200x800x870H mm
2-parts lid	600 x 400 mm
3 Pieces per pack.	📦 1
Pieces per pallet / dimens.	📦 176 / 1200x800x870H mm
Cover	600 x 400 mm
4 Pieces per pack.	📦 1
Pieces per pallet / dimens.	📦 176 / 1200x800x870H mm
Disposable security seal	
5 Pieces per pack	📦 500
Pair closing clips	
6 Pieces per pack	📦 10
Label holders	
7 Pieces per pack	📦 10

	ARTICLE	WALLS			BOTTOM			HANDLES		GR.	PACKAGING		UNIT PRICE €
		Closed	Perforated	Picking short side	Closed	Perforated	Reinforced	Closed	Open		Qty. per pack.	Qty. per pallet	
	S NX 6442S 5101	■			■	■		■		3018	1	20	
	U NX 6442U 5101			■	■			■		2759	1	20	
	ARTICLE ON REQUEST												
	S NX 6442S 5401	■			■	■		■		3154	1	20	
	U NX 6442U 5401			■	■			■		2883	1	20	

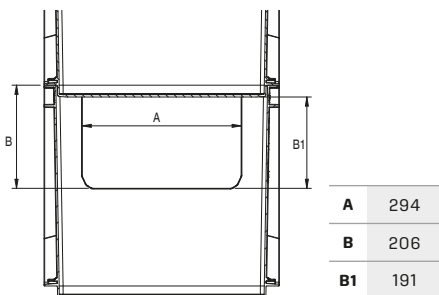
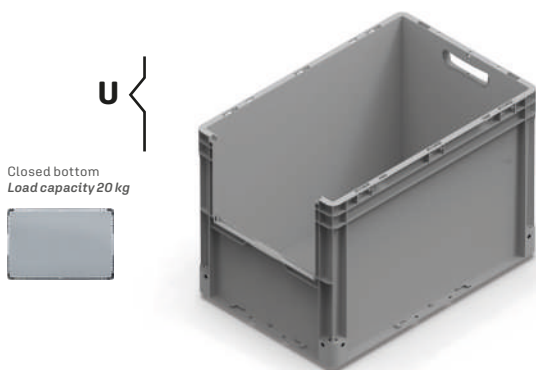
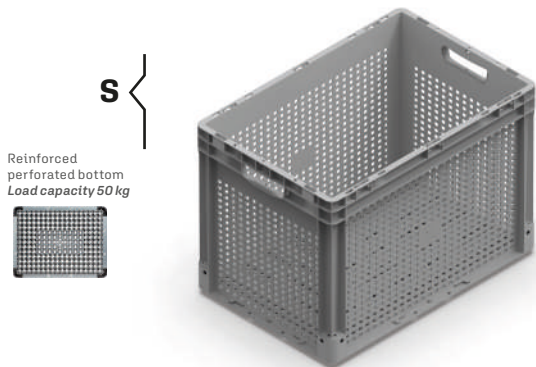

S	
Stacked edge height	405 mm
Usable stacked height / with lid	390 mm / 394 mm
Usable internal dimensions	561 x 361 x 405 H mm
Volume	82,8 L
Pieces per package / pallet	1  20
Package dimensions	620 x 420 x 455 H mm
Pallet dimensions	1200 x 800 x 2190 H mm
U	
Stacked edge height	405 mm
Usable stacked height / with lid	402 mm / 406 mm
Usable internal dimensions	561 x 361 x 417 H mm
Volume	85,6 L
Pieces per package / pallet	1  20
Package dimensions	620 x 420 x 455 H mm
Pallet dimensions	1200 x 800 x 2190 H mm

DATASHEET

◀ CONTINUED ON PREVIOUS PAGE









iMilani srl reserves the right to alter the characteristics of products without notice. The values shown are nominal, with a +/- 1% tolerance for size, depending on the material, and a +/- 3% for weight.

ARTICLES ON REQUEST

Minimum order.....200 boxes  
Guaranteed shipping within.....60 days

# 600 x 400 mm

iMICUBE

	ARTICLE	SEPARATE LID	HINGED LID	2 PARTS LID	GR.	PACKAGING		UNIT PRICE €	
						Qty. per pack.	Qty. per pallet		
1	NX 64SE 5101	■			751	1	176		
	NX 64SE 5401	■			785	1	176	ECOGREEN ✓	
2	NX 64HG 5101		■		710	1	176		
	NX 64HG 5401		■		742	1	176	ECOGREEN ✓	
3	NX 64CR 5101			■	1016	1	176		
	NX 64CR 5401			■	1062	1	176	ECOGREEN ✓	
4	NX 64CV 5101	Cover			845	1	176		
	NX 64CV 5401	Cover			883	1	176	ECOGREEN ✓	
5	NX SEAL46 5113			2 x			500		
6	AT LOCK 8113		2 x				10		
7	LH TYT	Label holders for all sides					10		
8	NX WC64426896	Door for H 420					1		



1



2

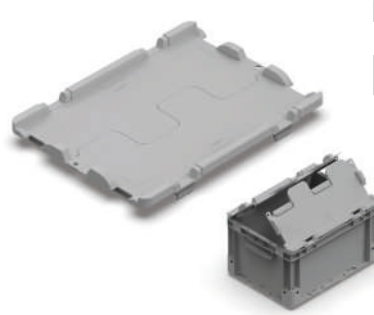

3



4



5



6



7



8

## DATASHEET

Separate lid	600 x 400 mm
1 Pieces per pack.	1
Pieces per pallet / dims.	176 / 1200x800x870H mm
Hinged lid	600 x 400 mm
2 Pieces per pack.	1
Pieces per pallet / dims.	176 / 1200x800x870H mm
2-parts lid	600 x 400 mm
3 Pieces per pack.	1
Pieces per pallet / dims.	176 / 1200x800x870H mm
Cover	600 x 400 mm
4 Pieces per pack.	1
Pieces per pallet / dims.	176 / 1200x800x870H mm
Disposable security seal	
5 Pieces per pack	500
Pair closing clips	
6 Pieces per pack	10
Label holders	
7 Pieces per pack	10
Door for H 420	
8 Pieces per pack	1

iMilani srl reserves the right to alter the characteristics of products without notice. The values shown are nominal, with a +/- 1% tolerance for size, depending on the material, and a +/- 3% for weight.

**600 x 400 mm**

iMICUBE

1



2



3



4



5



ARTICLE	1 SÉPARATION	2 SÉPARATIONS	4 SÉPARATIONS	GR.	EMBALLAGE		PRIX UNITAIRE €	
					Qté par paq.	Qté par palette		
ECOGREEN ✓ 1 AT 64S1 5407	■				428	10	160	
ECOGREEN ✓ 2 AT 64S2 5407		■			460	10	160	
ECOGREEN ✓ 3 AT 64S4 5407			■		489	10	160	
ECOGREEN ✓ 4 AT 64S0 5407	■				345	20	320	
5 AT LID6 6896	Transparent lid						20	

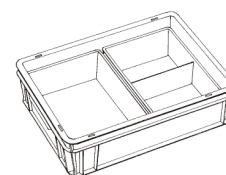

Subdivision with 1 and 2 compartments

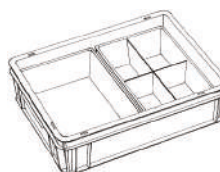

Subdivision with 1 and 4 compartments



Subdivision with 2 and 4 compartments

1	Partitioned box 1 partition	357 x 278 x 90 H mm
	Pieces per pack / pallet	📦 10 🚚 160
	Package dimensions	565 x 375 x 460 H mm
	Pallet dimensions	1200 x 800 x 1990 H mm
2	Partitioned box 2 partitions	357 x 278 x 90 H mm
	Pieces per pack / pallet	📦 10 🚚 160
	Package dimensions	565 x 375 x 460 H mm
	Pallet dimensions	1200 x 800 x 1990 H mm
3	Partitioned box 4 partitions	357 x 278 x 90 H mm
	Pieces per pack / pallet	📦 10 🚚 160
	Package dimensions	565 x 375 x 460 H mm
	Pallet dimensions	1200 x 800 x 1990 H mm
4	Partitioned box 1 partition	277 x 177 x 99 H mm
	Pieces per pack / pallet	📦 20 🚚 320
	Package dimensions	565 x 375 x 460 H mm
	Pallet dimensions	1200 x 800 x 1990 H mm
5	Transparent polystyrene lid	
	Pieces per pack / pallet	📦 20
Package dimensions		365 x 295 x 180 H mm

# 600 x 400 mm

	ARTICLE	H 45	H 70	H 90	H 120	H 180	H 220	PACKAGING		UNIT PRICE €
								Qty. per pack.	Qty. per pallet	
1	DI 35545246801	■						10		♻️ PS
	DI 55545246801	■						10		
2	DI 35570246801		■					10		♻️ PS
	DI 55570246801		■					10		
3	DI 35590246801			■				10		♻️ PS
	DI 55590246801			■				10		
4	DI 35512246801				■			10		♻️ PS
	DI 55512246801				■			10		
5	DI 35518246801					■		10		♻️ PS
	DI 55518246801					■		10		
6	DI 35522246801						■	10		♻️ PS
	DI 55522246801						■	10		
7	DI 64SHT 5101							10		♻️ PS

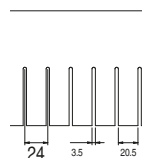

6801  
Pitch 24 mm

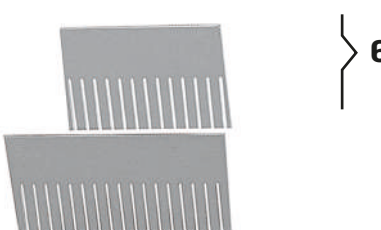
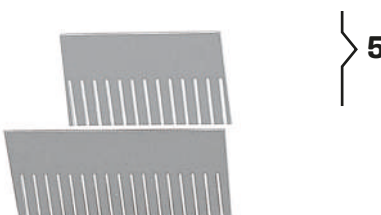
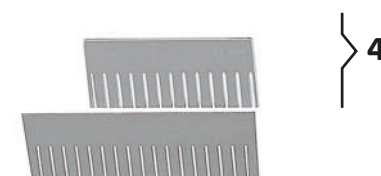
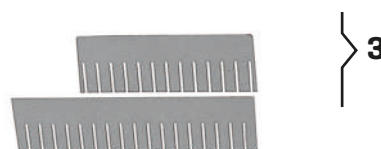
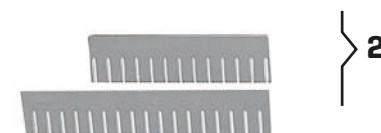

## DATASHEET

1	Comb divider 355 x 45 H mm per box 600x400x75H mm	10 items
	Comb divider 555 x 45 H mm per box 600x400x75H mm	10 items
2	Comb divider 355 x 70 H mm per box 600x400x120 H mm	10 items
	Comb divider 555 x 70 H mm per box 600x400x120 H mm	10 items
3	Comb divider 355 x 90 H mm per box 600x400x120 H mm	10 items
	Comb divider 555 x 90 H mm per box 600x400x120 H mm	10 items
4	Comb divider 355 x 120 H mm per box 600x400x170 H mm	10 items
	Comb divider 555 x 120 H mm per box 600x400x170 H mm	10 items
5	Comb divider 355 x 180 H mm per box 600x400x220 H mm	10 items
	Comb divider 555 x 180 H mm per box 600x400x220 H mm	10 items
6	Comb divider 355 x 220 H mm per box 600x400x270 H mm	10 items
	Comb divider 555 x 220 H mm per box 600x400x270 H mm	10 items
7	Intermediate partition shelf 555 x 355 mm	10 items



# ATHENA

The variety of materials and sizes of the **ATHENA** series of boxes make them suitable for use in all sectors, with optimal adaptability to storage and distribution requirements. They are stackable with and without lids and conform to euro-pallet sizes.

Edges and reinforcements are designed to give the boxes structural strength to withstand the heaviest loads. The bottoms and walls of the boxes can be closed or perforated.

The handles can also be in open or closed mode. The varied composition of these elements permits a wide range of solutions and does not exclude the option of customised solutions.

## BOTTOM

micube

800x600 mm  
bottom for accessories

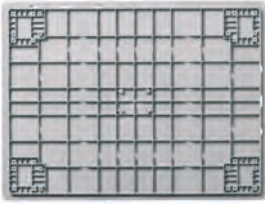

## ACCESSORIES

with feet



with crossbars



with wheels



to add to the feet



ARTICLE	WALLS		BOTTOM			HANDLES		GR.	PACKAGING		UNIT PRICE €	
	Closed	Perforated	Closed	Perforated	Reinforced	Closed	Open		Qty. per pack.	Qty. per pallet		
AT 8612C 5101	<				<	<		3458	4	40		
<b>C</b> AT 8612C 5207	<				<	<		3873	4	40		
<b>ECOGREEN</b> AT 8612C 5401	<				<	<		3614	4	40		
<b>ACCESSORIES</b>												
AT FEET 5101	Foot							136	1			
<b>1</b> AT FEET 5207	Order 4 pieces							152	1			
<b>ECOGREEN</b> AT FEET 5401								142	1			
AT RUNN 5101	Crossbar to be slotted under the feet AT FEET							382	1			
<b>2</b> AT RUNN 5207	Order 2 pieces							428	1			
<b>ECOGREEN</b> AT RUNN 5401								400	1			
<b>3</b> AT WRCT 100	Swivel wheel D. 100 mm in rubber								1			
AT WRCT 125	Swivel wheel D. 125 mm in rubber								1			

**C**

Reinforced bottom  
Load capacity 60 kg



**1**



Order 4 feet

**2**

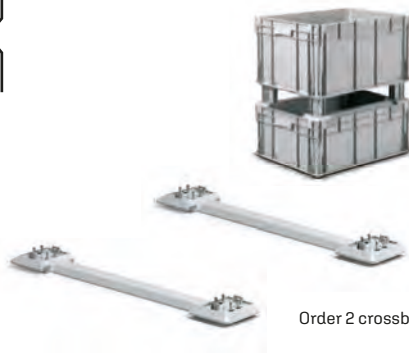

Order 2 crossbars

**3**



Order 4 wheels  
AT WRCT 100/125  
or alternatively those on  
the opposite page

All accessories include fixing screws when required

Accessories supplied mounted  
When fitted with wheels, the boxes are not stackable

iMilani srl reserves the right to alter the characteristics of products without notice. The values shown are nominal, with a +/- 1% tolerance for size, depending on the material, and a +/- 3% for weight.

**C**

Stacked edge height	105 mm
Usable stacked height / with lid	86 mm / 93 mm
Usable internal dimensions	755 x 555 x 101 H mm
Volume	49 L
Pieces per package / pallet	4  40
Package dimensions	820 x 620 x 455 H mm
Pallet dimensions	1200 x 800 x 2265 H mm
<b>1</b>	
Feet with fixing screws	100 H mm
Pieces per package	1
<b>2</b>	
Crossbar	25 H mm
Pieces per package	1
<b>3</b>	
Swivel wheel in rubber	diamètre 100/125 mm
Pieces per package	1



# 800 x 600 mm H 120 mm

iMICUBE

ARTICLE	SEPARATE LID	GR.	PACKAGING		UNIT PRICE €
			Qty. per pack.	Qty. per pallet	
1 AT 86SE 5101	<	1978	5	60	
AT 86SE 5207	<	2215	5	60	
AT 86SE 5401	<	2067	5	60	
2 SPRING 0099	Document holder spring		10		
3 AT WRBT 100	Swivel wheel in rubber w/brake D. 100 mm		1		
AT WRBT 125	Swivel wheel in rubber w/brake D. 125 mm		1		
4 AT WRCF 100	Swivel wheel in rubber D. 100 mm		1		
AT WRCF 125	Swivel wheel in rubber D. 125 mm		1		
5 AT WNBT 100	Swivel wheel in nylon w/brake D. 100 mm		1		
AT WNBT 125	Swivel wheel in nylon w/brake D. 125 mm		1		
6 AT WNCF 100	Fixed wheel in nylon D. 100 mm		1		
AT WNCF 125	Fixed wheel in nylon D. 125 mm		1		
7 AT WHBT 125	Swivel wheel non-marking rubber w/brake D. 125 mm		1		
8 AT WHCF 125	Fixed wheel non-marking rubber D. 125 mm		1		



ECOGREEN



All accessories include fixing screws when required

## DATASHEET

1	Separate lid	800 x 600 mm
	Pieces per pack / pallet	5 60
	Package dimensions	800 x 600 x 150 H mm
	Pallet dimensions	1200 x 800 x 860 H mm
2	Document holder spring	
	Pieces per package	10
3	Swivel wheel in rubber with brake D. 100 mm footprint 128 H mm	
	Swivel wheel in rubber with brake D. 125 mm footprint 155 H mm	
4	Rubber fixed wheel diameter 100 mm - footprint 128 mm H	
	Rubber fixed wheel diameter 125 mm - footprint 155 mm H	
5	Swivel wheel in nylon with brake diameter 100 mm footprint 128 H mm	
	Swivel wheel in nylon with brake diameter 125 mm footprint 155 H mm	
6	Fixed wheel in nylon diameter 100 mm footprint 128 mm H	
	Fixed wheel in nylon diameter 125 mm footprint 155 mm H	
7	Swivel wheel in non-marking rubber with brake diameter 125 mm - footprint 155 H mm	
8	Fixed wheel in non-marking rubber diameter 125 mm - footprint 155 H mm	



iMilani srl reserves the right to alter the characteristics of products without notice. The values shown are nominal, with a +/- 1% tolerance for size, depending on the material, and a +/- 3% for weight.

ARTICLE	WALLS		BOTTOM			HANDLES		GR.	PACKAGING		UNIT PRICE €	
	Closed	Perforated	Closed	Perforated	Reinforced	Closed	Open		Qty. per pack.	Qty. per pallet		
AT 8617C 5101	<				<	<		3804	3	28		
<b>C</b> AT 8617C 5207	<				<	<		4260	3	28		
<b>ECOGREEN</b> AT 8617C 5401	<				<	<		3975	3	28		
<b>ACCESSORIES</b>												
AT FEET 5101	Foot							136	1			
<b>1</b> AT FEET 5207	Order 4 pieces							152	1			
<b>ECOGREEN</b> AT FEET 5401								142	1			
AT RUNN 5101	Crossbar to be slotted under the feet AT FEET							382	1			
<b>2</b> AT RUNN 5207	Order 2 pieces							428	1			
<b>ECOGREEN</b> AT RUNN 5401								400	1			
<b>3</b> AT WRCT 100	Swivel wheel D. 100 mm in rubber									1		
AT WRCT 125	Swivel wheel D. 125 mm in rubber									1		

**C**

Reinforced bottom  
Load capacity 60 kg



**1**

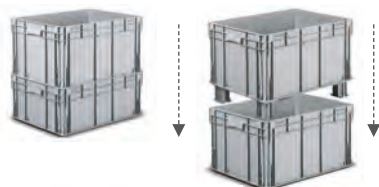

Order 4 feet

**2**

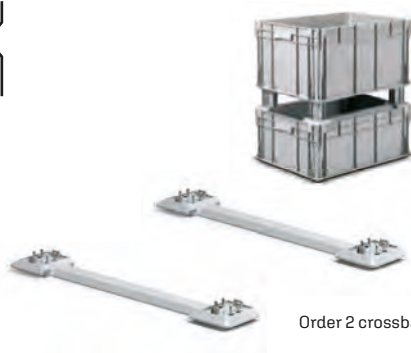

Order 2 crossbars

**3**

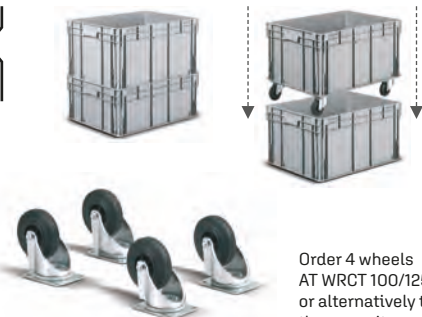

Order 4 wheels  
AT WRCT 100/125  
or alternatively those on  
the opposite page

All accessories include fixing screws when required

Accessories supplied mounted

iMilani srl reserves the right to alter the characteristics of products without notice. The values shown are nominal, with a +/- 1% tolerance for size, depending on the material, and a +/- 3% for weight.

**C**

Stacked edge height	155 mm
Usable stacked height / with lid	136 mm / 143 mm
Usable internal dimensions	755 x 555 x 151 H mm
Volume	69 L
Pieces per package / pallet	3  28
Package dimensions	820 x 620 x 500 H mm
Pallet dimensions	1200 x 800 x 2335 H mm
<b>1</b>	
Feet with fixing screws	100 H mm
Pieces per package	1
<b>2</b>	
Crossbar	25 H mm
Pieces per package	1
<b>3</b>	
Swivel wheel in rubber	diamètre 100/125 mm
Pieces per package	1

DATASHEET

# 800 x 600 mm H 170 mm

iMICUBE

ARTICLE	SEPARATE LID	GR.	PACKAGING		UNIT PRICE €
			Qty. per pack.	Qty. per pallet	
AT 86SE 5101	<	1978	5	60	
1 AT 86SE 5207	<	2215	5	60	
AT 86SE 5401	<	2067	5	60	
2 SPRING 0099	Document holder spring		10		
3 AT LH64 5107	Label holders		10		
4 LB 21081 0325	A4 sheet with 3 labels		25		
5 AT WRBT 100	Swivel wheel in rubber w/brake D. 100 mm		1		
AT WRBT 125	Swivel wheel in rubber w/brake D. 125 mm		1		
6 AT WRCF 100	Swivel wheel in rubber D. 100 mm		1		
AT WRCF 125	Swivel wheel in rubber D. 125 mm		1		
7 AT WNBT 100	Swivel wheel in nylon w/brake D. 100 mm		1		
AT WNBT 125	Swivel wheel in nylon w/brake D. 125 mm		1		
8 AT WNCF 100	Fixed wheel in nylon D. 100 mm		1		
AT WNCF 125	Fixed wheel in nylon D. 125 mm		1		
9 AT WHBT 125	Swivel wheel non-marking rubber w/brake D. 125 mm		1		
10 AT WHCF 125	Fixed wheel non-marking rubber D. 125 mm		1		



ECOGREEN

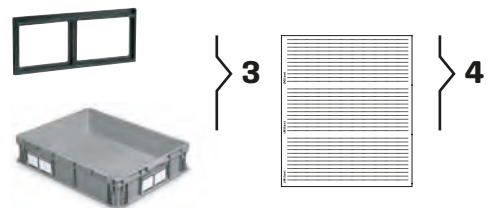

All accessories include fixing screws when required

## DATASHEET

Separate lid	800 x 600 mm
1 Pieces per pack / pallet	5 60
Package dimensions	800 x 600 x 150 H mm
Pallet dimensions	1200 x 800 x 860 H mm
Document holder spring	
2 Pieces per package	10
Label holders	215 x 85 H mm
3 Pieces per package	10
A4 sheet with 3 labels	210 x 81 H mm
4 Pieces per package	25
Swivel wheel in rubber with brake D. 100 mm footprint 128 H mm	
5 Swivel wheel in rubber with brake D. 125 mm footprint 155 H mm	
Rubber fixed wheel diameter 100 mm - footprint 128 mm H	
6 Rubber fixed wheel diameter 125 mm - footprint 155 mm H	
Swivel wheel in nylon with brake diameter 100 mm footprint 128 H mm	
7 Swivel wheel in nylon with brake diameter 125 mm footprint 155 H mm	
Fixed wheel in nylon diameter 100 mm footprint 128 mm H	
8 Fixed wheel in nylon diameter 125 mm footprint 155 mm H	
Swivel wheel in non-marking rubber with brake diameter 125 mm - footprint 155 H mm	
9 Fixed wheel in non-marking rubber diameter 125 mm - footprint 155 H mm	
10	

iMilani srl reserves the right to alter the characteristics of products without notice. The values shown are nominal, with a +/- 1% tolerance for size, depending on the material, and a +/- 3% for weight.

Reinforced bottom  
Load capacity 60 kg

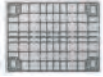

C



1

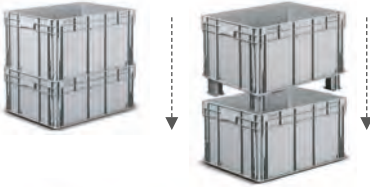

Order 4 feet

2

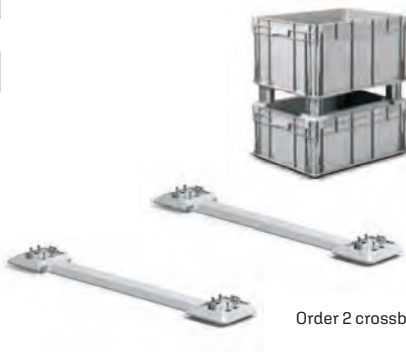

Order 2 crossbars

3

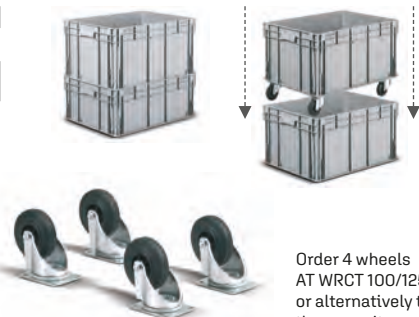

Order 4 wheels  
AT WRCT 100/125  
or alternatively those on  
the opposite page

Accessories supplied mounted

iMilani srl reserves the right to alter the characteristics of products without notice. The values shown are nominal, with a +/- 1% tolerance for size, depending on the material, and a +/- 3% for weight.

ARTICLE	WALLS		BOTTOM			HANDLES		GR.	PACKAGING		UNIT PRICE €
	Closed	Perforated	Closed	Perforated	Reinforced	Closed	Open		Qty. per pack.	Qty. per pallet	
AT 8622C 5101	<				<	<		4588	2	20	
<b>C</b> AT 8622C 5207	<				<	<		5138	2	20	
<b>ECOGREEN</b> ✓ AT 8622C 5401	<				<	<		4795	2	20	
<b>ACCESSORIES</b>											
<b>1</b> AT FEET 5101	Foot							136	1		
AT FEET 5207	Order 4 pieces							152	1		
<b>ECOGREEN</b> ✓ AT FEET 5401								142	1		
<b>2</b> AT RUNN 5101	Crossbar to be slotted under the feet AT FEET							382	1		
AT RUNN 5207	Order 2 pieces							428	1		
<b>ECOGREEN</b> ✓ AT RUNN 5401								400	1		
<b>3</b> AT WRCT 100	Swivel wheel D. 100 mm in rubber								1		
AT WRCT 125	Swivel wheel D. 125 mm in rubber								1		

All accessories include fixing screws when required

C	
Stacked edge height	205 mm
Usable stacked height / with lid	186 mm / 193 mm
Usable internal dimensions	755 x 555 x 201 H mm
Volume	90 L
Pieces per package / pallet	2  20
Package dimensions	820 x 620 x 445h H mm
Pallet dimensions	1200 x 800 x 2215 H mm
1	
Feet with fixing screws	100 H mm
Pieces per package	1
2	
Crossbar	25 H mm
Pieces per package	1
3	
Swivel wheel in rubber	diamètre 100/125 mm
Pieces per package	1

# 800 x 600 mm H 220 mm

iMICUBE

ARTICLE	SEPARATE LID	GR.	PACKAGING		UNIT PRICE €
			Qty. per pack.	Qty. per pallet	
1 AT 86SE 5101	<	1978	5	60	 
AT 86SE 5207	<	2215	5	60	
AT 86SE 5401	<	2067	5	60	
2 SPRING 0099	Document holder spring		10		
3 AT LH64 5107	Label holders		10		
4 LB 21081 0325	A4 sheet with 3 labels		25		
5 AT WRBT 100	Swivel wheel in rubber w/brake D. 100 mm		1		
AT WRBT 125	Swivel wheel in rubber w/brake D. 125 mm		1		
6 AT WRCF 100	Swivel wheel in rubber D. 100 mm		1		
AT WRCF 125	Swivel wheel in rubber D. 125 mm		1		
7 AT WNBT 100	Swivel wheel in nylon w/brake D. 100 mm		1		
AT WNBT 125	Swivel wheel in nylon w/brake D. 125 mm		1		
8 AT WNCF 100	Fixed wheel in nylon D. 100 mm		1		
AT WNCF 125	Fixed wheel in nylon D. 125 mm		1		
9 AT WHBT 125	Swivel wheel non-marking rubber w/brake D. 125 mm		1		
10 AT WHCF 125	Fixed wheel non-marking rubber D. 125 mm		1		

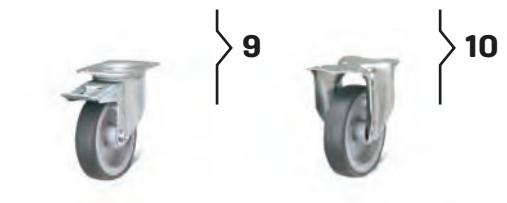
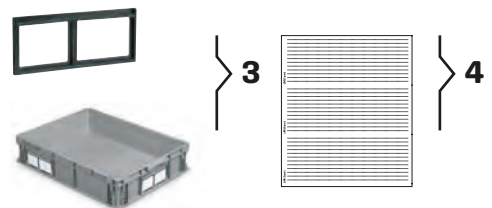

All accessories include fixing screws when required

## DATASHEET

Separate lid	800 x 600 mm
1 Pieces per pack / pallet	5  60
Package dimensions	800 x 600 x 150 H mm
Pallet dimensions	1200 x 800 x 860 H mm
Document holder spring	
2 Pieces per package	10
Label holders	215 x 85 H mm
3 Pieces per package	10
A4 sheet with 3 labels	210 x 81 H mm
4 Pieces per package	25
5 Swivel wheel in rubber with brake D. 100 mm footprint 128 H mm	
Swivel wheel in rubber with brake D. 125 mm footprint 155 H mm	
6 Rubber fixed wheel diameter 100 mm - footprint 128 mm H	
Rubber fixed wheel diameter 125 mm - footprint 155 mm H	
7 Swivel wheel in nylon with brake diameter 100 mm footprint 128 H mm	
Swivel wheel in nylon with brake diameter 125 mm footprint 155 H mm	
8 Fixed wheel in nylon diameter 100 mm footprint 128 mm H	
Fixed wheel in nylon diameter 125 mm footprint 155 mm H	
9 Swivel wheel in non-marking rubber with brake diameter 125 mm - footprint 155 H mm	
10 Fixed wheel in non-marking rubber diameter 125 mm - footprint 155 H mm	

iMilani srl reserves the right to alter the characteristics of products without notice. The values shown are nominal, with a +/- 1% tolerance for size, depending on the material, and a +/- 3% for weight.

ARTICLE	WALLS		BOTTOM			HANDLES		GR.	PACKAGING		UNIT PRICE €	
	Closed	Perforated	Closed	Perforated	Reinforced	Closed	Open		Qty. per pack.	Qty. per pallet		
AT 8632C 5101	<				<	<		5422	2	14		
<b>C</b> AT 8632C 5207	<				<	<		6072	2	14		
AT 8632C 5401	<				<	<		5665	2	14		
<b>ACCESSORIES</b>												
AT FEET 5101	Foot							136	1			
AT FEET 5207	Order 4 pieces							152	1			
AT FEET 5401								142	1			
AT RUNN 5101	Crossbar to be slotted under the feet AT FEET							382	1			
AT RUNN 5207	Order 2 pieces							428	1			
AT RUNN 5401								400	1			
<b>3</b> AT WRCT 100	Swivel wheel D. 100 mm in rubber								1			
AT WRCT 125	Swivel wheel D. 125 mm in rubber								1			

Reinforced bottom  
Load capacity 60 kg

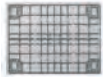

**C**



**1**



Order 4 feet

**2**

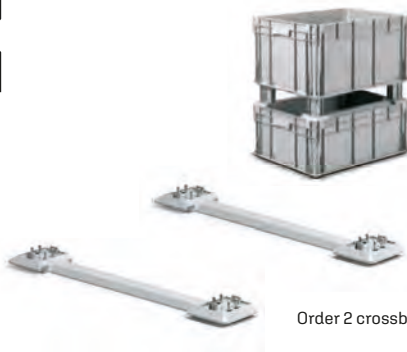

Order 2 crossbars

**3**

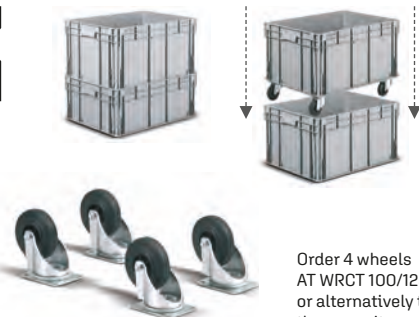

Order 4 wheels  
AT WRCT 100/125  
or alternatively those on  
the opposite page

All accessories include fixing screws when required

Accessories supplied mounted

iMilani srl reserves the right to alter the characteristics of products without notice. The values shown are nominal, with a +/- 1% tolerance for size, depending on the material, and a +/- 3% for weight.

**C**

Stacked edge height	310 mm
Usable stacked height / with lid	291 mm / 298 mm
Usable internal dimensions	755 x 555 x 306 H mm
Volume	130 L
Pieces per package / pallet	2  14
Package dimensions	820 x 620 x 655 H mm
Pallet dimensions	1200 x 800 x 2335 H mm

**1**

Feet with fixing screws	100 H mm
Pièces par paquet	1

**2**



Crossbar	25 H mm
Pieces per package	1

**3**

Swivel wheel in rubber	diamètre 100/125 mm
Pièces par paquet	1

# 800 x 600 mm H 320 mm



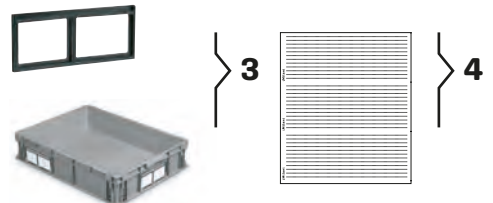

iMICUBE

ARTICLE	SEPARATE LID	GR.	PACKAGING		UNIT PRICE €
			Qty. per pack.	Qty. per pallet	
1 AT 86SE 5101	<	1978	5	60	 
AT 86SE 5207	<	2215	5	60	
AT 86SE 5401	<	2067	5	60	
2 SPRING 0099	Document holder spring		10		
3 AT LH64 5107	Label holders		10		
4 LB 21081 0325	A4 sheet with 3 labels		25		
5 AT WRBT 100	Swivel wheel in rubber w/brake D. 100 mm		1		
AT WRBT 125	Swivel wheel in rubber w/brake D. 125 mm		1		
6 AT WRCF 100	Swivel wheel in rubber D. 100 mm		1		
AT WRCF 125	Swivel wheel in rubber D. 125 mm		1		
7 AT WNBT 100	Swivel wheel in nylon w/brake D. 100 mm		1		
AT WNBT 125	Swivel wheel in nylon w/brake D. 125 mm		1		
8 AT WNCF 100	Fixed wheel in nylon D. 100 mm		1		
AT WNCF 125	Fixed wheel in nylon D. 125 mm		1		
9 AT WHBT 125	Swivel wheel non-marking rubber w/brake D. 125 mm		1		
10 AT WHCF 125	Fixed wheel non-marking rubber D. 125 mm		1		



 All accessories include fixing screws when required

## DATASHEET

Separate lid	800 x 600 mm
1 Pieces per pack / pallet	 5  60
Package dimensions	800 x 600 x 150 H mm
Pallet dimensions	1200 x 800 x 860 H mm
Document holder spring	
2 Pieces per package	 10
Label holders	215 x 85 H mm
3 Pieces per package	 10
A4 sheet with 3 labels	210 x 81 H mm
4 Pieces per package	 25
Swivel wheel in rubber with brake D. 100 mm footprint 128 H mm	
5 Swivel wheel in rubber with brake D. 125 mm footprint 155 H mm	
Rubber fixed wheel diameter 100 mm - footprint 128 mm H	
6 Rubber fixed wheel diameter 125 mm - footprint 155 mm H	
Swivel wheel in nylon with brake diameter 100 mm footprint 128 H mm	
7 Swivel wheel in nylon with brake diameter 125 mm footprint 155 H mm	
Fixed wheel in nylon diameter 100 mm footprint 128 mm H	
8 Fixed wheel in nylon diameter 125 mm footprint 155 mm H	
Swivel wheel in non-marking rubber with brake diameter 125 mm - footprint 155 H mm	
9 Fixed wheel in non-marking rubber diameter 125 mm - footprint 155 H mm	
10	

iMilani srl reserves the right to alter the characteristics of products without notice. The values shown are nominal, with a +/- 1% tolerance for size, depending on the material, and a +/- 3% for weight.

Reinforced bottom  
Load capacity 60 kg

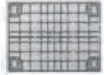

C



1

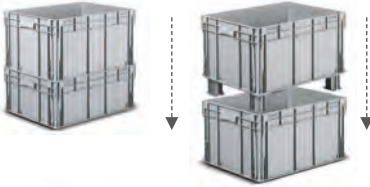

Order 4 feet

2

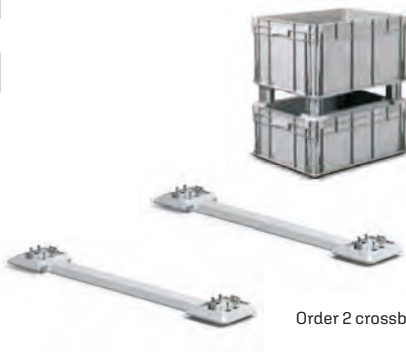

Order 2 crossbars

3

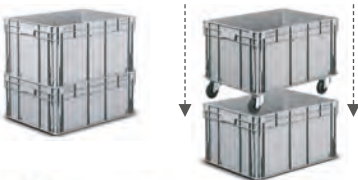

Order 4 wheels  
AT WRCT 100/125  
or alternatively those on  
the opposite page

Accessories supplied mounted

iMilani srl reserves the right to alter the characteristics of products without notice. The values shown are nominal, with a +/- 1% tolerance for size, depending on the material, and a +/- 3% for weight.

ARTICLE	WALLS		BOTTOM			HANDLES		GR.	PACKAGING		UNIT PRICE €	
	Closed	Perforated	Closed	Perforated	Reinforced	Closed	Open		Qty. per pack.	Qty. per pallet		
AT 8643C5101	<				<	<		6238	1	10		
<b>C</b> AT 8643C5207	<				<	<		6986	1	10		
<b>ECOGREEN</b> AT 8643C5401	<				<	<		6518	1	10		
<b>ACCESSORIES</b>												
AT FEET 5101	Foot							136	1			
<b>1</b> AT FEET 5207	Order 4 pieces							152	1			
<b>ECOGREEN</b> AT FEET 5401								142	1			
AT RUNN 5101	Crossbar to be slotted under the feet AT FEET							382	1			
<b>2</b> AT RUNN 5207	Order 2 pieces							428	1			
<b>ECOGREEN</b> AT RUNN 5401								400	1			
<b>3</b> AT WRCT 100	Swivel wheel D. 100 mm in rubber									1		
AT WRCT 125	Swivel wheel D. 125 mm in rubber									1		

All accessories include fixing screws when required

C	
Stacked edge height	415 mm
Usable stacked height / with lid	396 mm / 403 mm
Usable internal dimensions	755 x 555 x 411 H mm
Volume	175 L
Pieces per package / pallet	1  10
Package dimensions	820 x 620 x 450 H mm
Pallet dimensions	1200 x 800 x 2240 H mm
1	
Feet with fixing screws	100 H mm
Pieces per package	1
2	
Crossbar	25 H mm
Pieces per package	1
3	
Swivel wheel in rubber	diamètre 100/125 mm
Pieces per package	1



# 800 x 600 mm H 430 mm

iMICUBE

ARTICLE	SEPARATE LID	GR.	PACKAGING		UNIT PRICE €
			Qty. per pack.	Qty. per pallet	
AT 86SE 5101	<	1978	5	60	
1 AT 86SE 5207	<	2215	5	60	
AT 86SE 5401	<	2067	5	60	
2 SPRING 0099	Document holder spring		10		
3 AT LH64 5107	Label holders		10		
4 LB 21081 0325	A4 sheet with 3 labels		25		
5 AT WRBT 100	Swivel wheel in rubber w/brake D. 100 mm		1		
AT WRBT 125	Swivel wheel in rubber w/brake D. 125 mm		1		
6 AT WRCF 100	Swivel wheel in rubber D. 100 mm		1		
AT WRCF 125	Swivel wheel in rubber D. 125 mm		1		
7 AT WNBT 100	Swivel wheel in nylon w/brake D. 100 mm		1		
AT WNBT 125	Swivel wheel in nylon w/brake D. 125 mm		1		
8 AT WNCF 100	Fixed wheel in nylon D. 100 mm		1		
AT WNCF 125	Fixed wheel in nylon D. 125 mm		1		
9 AT WHBT 125	Swivel wheel non-marking rubber w/brake D. 125 mm		1		
10 AT WHCF 125	Fixed wheel non-marking rubber D. 125 mm		1		



ECOLOGREEN

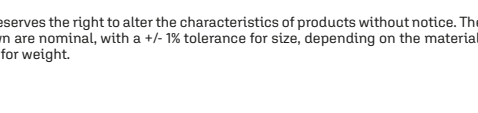
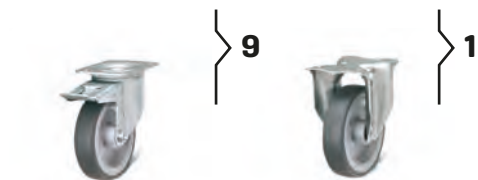
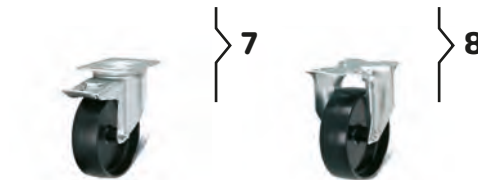
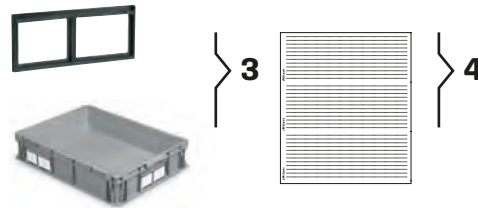

All accessories include fixing screws when required

## DATASHEET

Separate lid	800 x 600 mm
1 Pieces per pack / pallet	5 60
Package dimensions	800 x 600 x 150 H mm
Pallet dimensions	1200 x 800 x 860 H mm
Document holder spring	
2 Pieces per package	10
Label holders	215 x 85 H mm
3 Pieces per package	10
A4 sheet with 3 labels	210 x 81 H mm
4 Pieces per package	25
5 Swivel wheel in rubber with brake D. 100 mm footprint 128 H mm	
Swivel wheel in rubber with brake D. 125 mm footprint 155 H mm	
6 Rubber fixed wheel diameter 100 mm - footprint 128 mm H	
Rubber fixed wheel diameter 125 mm - footprint 155 mm H	
7 Swivel wheel in nylon with brake diameter 100 mm footprint 128 H mm	
Swivel wheel in nylon with brake diameter 125 mm footprint 155 H mm	
8 Fixed wheel in nylon diameter 100 mm footprint 128 mm H	
Fixed wheel in nylon diameter 125 mm footprint 155 mm H	
9 Swivel wheel in non-marking rubber with brake diameter 125 mm - footprint 155 H mm	
10 Fixed wheel in non-marking rubber diameter 125 mm - footprint 155 H mm	

iMilani srl reserves the right to alter the characteristics of products without notice. The values shown are nominal, with a +/- 1% tolerance for size, depending on the material, and a +/- 3% for weight.



# KRONOS

**KRONOS** foldable boxes have been designed and manufactured to significantly reduce the overall space occupied when not in use and during transport of empties. Their volume reduction of up to 75% therefore leads to high savings in storage and transport costs. KRONOS foldable boxes are equipped with a sturdy stacking edge and ribbed outer walls at the highest stress points:

these structural features give the boxes extra durability over time.

Lightweight and manageable, they adapt perfectly to normalised pallets. Their flat bottoms allow use on all types of roller beds, thus giving great flexibility also in internal handling.

The short sides are supplied with handy label holders and comfort handles for easy grip; the handles can be closed with the use of special casings.

handle closure casing

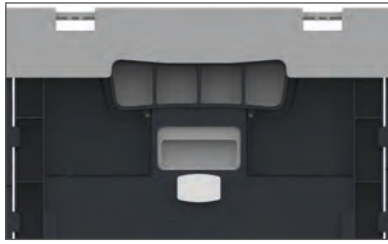

When used with the lid, the box can be fastened shut with disposable seals that are also customisable: the seals are applied on the two-flap lid and on the opening mechanism positioned on the two short sides of the box.

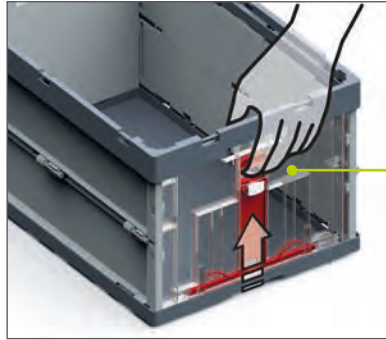

Clamping system

## FOLDABILITY

## DIMENSIONS

1



400 x 300 x 220 H mm



800 x 400 x 420 H mm



2



600 x 400 x 220 H mm

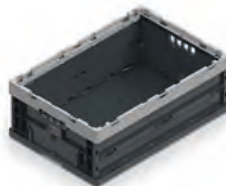

3

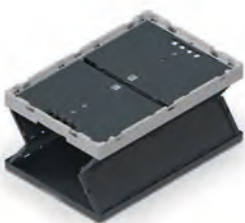

600 x 400 x 320 H mm



4

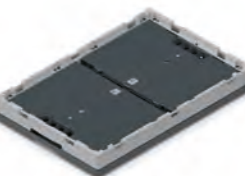

600 x 400 x 420 H mm



**FRAME COLOR CUSTOMIZATION ON REQUEST**

**MINIMUM OF 200 PIECES**  
*(with surcharge)*



H 220/320 = 80 mm  
 H 420 = 100 mm

100



iMilani

TECHNOLOGY. DYNAMISM. PEOPLE.

SPORT  
cisalfa

#IAMTHESPORT

NAPART

# 400 x 300 mm H 220 mm

iMICUBE

ARTICLE	WALLS		BOTTOM			HANDLES		GR.	PACKAGING		UNIT PRICE €
	Closed	Perforated	Closed	Perforated	Reinforced	Closed	Open		Qty. per pack.	Qty. per pallet	
<b>B</b> KR 4322B 5101	fl		fl			fl		1510	10	240	
<b>ACCESSORIES</b>											
<b>1</b> KR 43HG 51XL								277	10	360	
<b>2</b> KR PLUG 5101								18	10		
<b>3</b> KR SEAL 5113									500		



Closed bottom  
Load capacity 20 kg

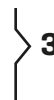
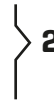
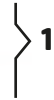

## DATASHEET

B	
Height closed	80 mm
Stacked edge height closed	72 mm
Stacked edge height open	212 mm
Usable stacked height / with lid	202 mm / 202 mm
Usable internal dimensions	354 x 256 x 216 H mm
Maximum stacking load capacity	160 kg
Volume	20 L
Pieces per pack / pallet	10  240
Package dimensions	620 x 420 x 388 H mm
Pallet dimensions	1200 x 800 x 2318 H mm

1	
Lid	400 x 300 mm
Pieces per pack. / dimension	5 / 410 x 180 x 150 H mm
Pieces per pallet / dimension	700 / 1200 x 800 x 870 H mm

2	
Handle closure casing	
Pieces per pack	10

3	
Disposable security seal	
Pieces per pack	500

THE LIDS ARE SUPPLIED SEPARATELY

iMilani srl reserves the right to alter the characteristics of products without notice. The values shown are nominal, with a +/- 1% tolerance for size, depending on the material, and a +/- 3% for weight.

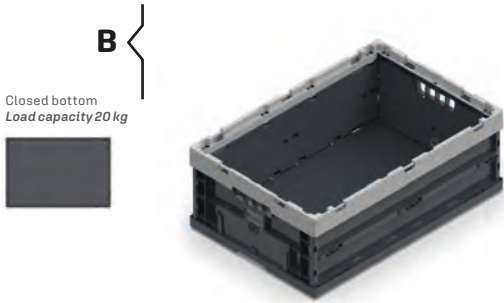

ARTICLE	WALLS		BOTTOM			HANDLES		GR.	PACKAGING		UNIT PRICE €
	Closed	Perforated	Closed	Perforated	Reinforced	Closed	Open		Qty. per pack.	Qty. per pallet	
<b>B</b> KR 6422B 5101	fl		fl			fl		2192	5	120	
<b>ACCESSORIES</b>											
<b>1</b> KR 64HG 51XL								590	10	180	
<b>2</b> KR PLUG 5101								18	10		
<b>3</b> KR SEAL 5113									500		

<b>B</b>	
Height closed	80 mm
Stacked edge height closed	72 mm
Stacked edge height open	212 mm
Usable stacked height / with lid	202 mm / 202 mm
Usable internal dimensions	554 x 356 x 216 H mm
Maximum stacking load capacity	160 kg
Volume	40 L
Pieces per pack / pallet	5  120
Package dimensions	620 x 420 x 388 H mm
Pallet dimensions	1200 x 800 x 2318 H mm
<b>1</b>	
Lid	600 x 400 mm
Pieces per pack. / dimension	5 / 610 x 250 x 150 H mm
Pieces per pallet / dimension	350 / 1200x800x870H mm
<b>2</b>	
Handle closure casing	
Pieces per pack	10
<b>3</b>	
Disposable security seal	
Pieces per pack	500

**DATASHEET**

THE LIDS ARE SUPPLIED SEPARATELY

# 600 x 400 mm H 320 mm

iMICUBE

ARTICLE	WALLS		BOTTOM			HANDLES		GR.	PACKAGING		UNIT PRICE €
	Closed	Perforated	Closed	Perforated	Reinforced	Closed	Open		Qty. per pack.	Qty. per pallet	
<b>B</b> KR 6432B 5101	fl		fl			fl		2780	5	120	
<b>ACCESSORIES</b>											
<b>1</b> KR 64HG 51XL								590	10	180	
<b>2</b> KR PLUG 5101								18	10		
<b>3</b> KR SEAL 5113									500		



Closed bottom  
Load capacity 20 kg

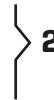
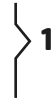

## DATASHEET

B	
Height closed	80 mm
Stacked edge height closed	72 mm
Stacked edge height open	312 mm
Usable stacked height / with lid	302 mm / 302 mm
Usable internal dimensions	554 x 356 x 316 H mm
Maximum stacking load capacity	160 kg
Volume	60 L
Pieces per pack / pallet	5  120
Package dimensions	620 x 420 x 388 H mm
Pallet dimensions	1200 x 800 x 2318 H mm
1	
Lid	600 x 400 mm
Pieces per pack. / dimension	10 / 620 x 250 x 180 H mm
Pieces per pallet / dimension	180 / 1240 x 800 x 670 H mm
2	
Handle closure casing	
Pieces per pack	10
3	
Disposable security seal	
Pieces per pack	500

THE LIDS ARE SUPPLIED SEPARATELY

iMilani srl reserves the right to alter the characteristics of products without notice. The values shown are nominal, with a +/- 1% tolerance for size, depending on the material, and a +/- 3% for weight.

600 x 400 mm H 420 mm

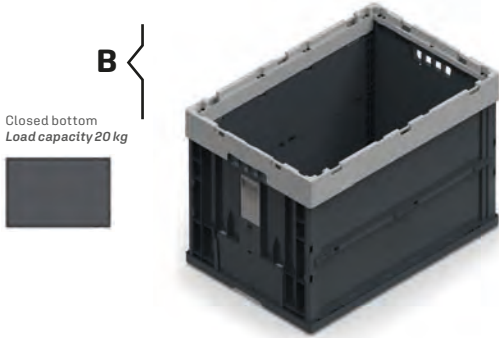

Closed bottom  
Load capacity 20 kg



ARTICLE	WALLS		BOTTOM			HANDLES		GR.	PACKAGING		UNIT PRICE €
	Closed	Perforated	Closed	Perforated	Reinforced	Closed	Open		Qty. per pack.	Qty. per pallet	
B KR 6442B 5101	fl		fl			fl		4010	4	96	
<b>ACCESSORIES</b>											
1 KR 64HG 51XL								590	10	180	
2 KR PLUG 5101								18	10		
3 KR SEAL 5113									500		

B	
Height closed	100 mm
Stacked edge height closed	92 mm
Stacked edge height open	412 mm
Usable stacked height / with lid	402 mm / 402 mm
Usable internal dimensions	554 x 356 x 416 H mm
Maximum stacking load capacity	160 kg
Volume	80 L
Pieces per pack / pallet	4  96
Package dimensions	620 x 420 x 411 H mm
Pallet dimensions	1200 x 800 x 2346 H mm
1	
Lid	600 x 400 mm
Pieces per pack. / dimension	10 / 620 x 250 x 180 H mm
Pieces per pallet / dimension	180 / 1240 x 800 x 670 H mm
2	
Handle closure casing	
Pieces per pack	10
3	
Disposable security seal	
Pieces per pack	500

DATASHEET

THE LIDS ARE SUPPLIED SEPARATELY

iMilani srl reserves the right to alter the characteristics of products without notice. The values shown are nominal, with a +/- 1% tolerance for size, depending on the material, and a +/- 3% for weight.



# 800 x 400 mm H 420 mm

iMICUBE

ARTICLE	WALLS		BOTTOM			HANDLES		GR.	PACKAGING		UNIT PRICE €
	Closed	Perforated	Closed	Perforated	Reinforced	Closed	Open		Qty. per pack.	Qty. per pallet	
<b>B</b> KR 8442B 5101	fl		fl			fl		4891	3	72	
<b>ACCESSORIES</b>											
<b>1</b> KR 84HG 51XL								808	10	200	
<b>2</b> KR PLUG 5101								18	10		
<b>3</b> KR SEAL 5113									500		

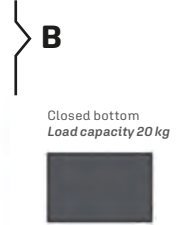
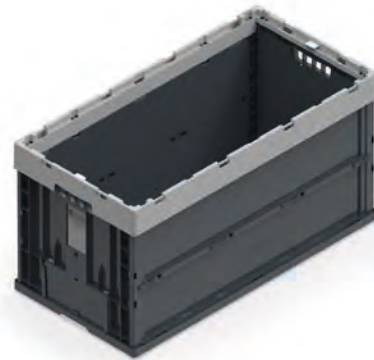

## DATASHEET

<b>B</b>	
Height closed	100 mm
Stacked edge height closed	92 mm
Stacked edge height open	412 mm
Usable stacked height / with lid	402 mm / 402 mm
Usable internal dimensions	754 x 356 x 416 H mm
Maximum stacking load capacity	160 kg
Volume	100 L
Pieces per pack / pallet	4  72
Package dimensions	820 x 420 x 411 H mm
Pallet dimensions	1200 x 800 x 2346 H mm
<b>1</b>	
Lid	800 x 400 mm
Pieces per pack. / dimension	10 / 820 x 250 x 180 H mm
Pieces per pallet / dimension	200 / 1250 x 820 x 850 H mm
<b>2</b>	
Handle closure casing	
Pieces per pack	10
<b>3</b>	
Disposable security seal	
Pieces per pack	500

THE LIDS ARE SUPPLIED SEPARATELY

iMilani srl reserves the right to alter the characteristics of products without notice. The values shown are nominal, with a +/- 1% tolerance for size, depending on the material, and a +/- 3% for weight.



106



# DELTA

Boxes in the **DELTA** series have a truncated cone structure, allowing for stable and safe stacking at full load. When empty they can be inserted one inside the other, resulting in a 70% reduction in volume.

These properties make them perfect for maximising warehouse space and transport space. They are particularly useful in shipment returns when empty or when packaging must take up the least possible space.

## SAFETY

iMICUBE



With the separate or hinged two-flap lids, the box can be fastened shut with dedicated disposable seals as well with commercially available nylon ties.

In addition to these, straps can be used both on the short and long sides, with containment points provided to prevent unauthorised removal of the straps.

## STACKING



By shifting the pair of yellow supports towards the inside or the outside, the boxes can be stacked and interlocked.



In the version with the two-flap lid, you can stack the boxes and interlock them. Stacking with the lids open ensures geometrical consistency of the battery of boxes.

## TRANSPORT

The wedges on the edges of short sides ensure the stability of the box in the event of accidental interruptions during the advance of automatic rollers and conveyor belts.

The external surface of the bottom has a smooth frame and rounded edge, for a silent impact on conveyor system rollers. Additionally, the surface of the central part is designed for increased adherence, ideal for safe transport over flat surfaces and conveyor belt ramps in ascent and descent.

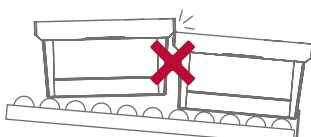



600 x 400 mm H 175 mm Version A  
 600 x 400 mm H 180 mm Version I  
 600 x 400 mm H 190 mm Version Z

iMICUBE

6417

DELTA

109

DE

	ARTICLE	BOTTOM WALLS HANDLES	SUPPORTS FOR STACKING	HINGED LID	GR.	PACKAGING		UNIT PRICE €
						Qté par paq.	Qté par palette	
A	DE 6417A 5701	■			1560	5	136	
I	DE 6417I 5701	■	■		1776	5	136	
Z	DE 6417Z 5701	■		■	2460	5	104	
ACCESSORIES								
1	DE 64SE 5701				960	1	160	
2	DE SEAL 5113					500		



Closed bottom  
Load capacity 20 kg



Closed bottom  
Load capacity 20 kg

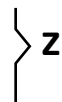

Closed bottom  
Load capacity 20 kg

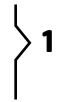

1

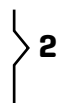

2

DATASHEET

A-I

Stacked edge height	50 mm
Usable height with lid	165 mm
Usable internal dimensions at the base	500 x 330 x 170 H mm
Volume	30 L
Pieces per pack / pallet	📦 5 🚚 136
Package dimensions	620 x 420 x 395 H mm
Pallet dimensions	1220 x 800 x 1955 H mm

Z

Stacked edge height	90 mm
Usable H.	165 mm
Usable internal dimensions at the base	500 x 330 x 170 H mm
Volume	27 L
Pieces per pack / pallet	📦 5 🚚 104
Package dimensions	630 x 510 x 463 H mm
Pallet dimensions	1300 x 1000 x 1896 H mm

1

Lid nominal measurement	600 x 400 mm
Pieces per pack. / dimension	📦 1 / 610 x 410 x 30 H mm
Pieces per pallet / dimension	🚚 160 / 1220x800x1000H mm

2

Disposable security seal	
Pieces per pack	📦 500

iMilani srl reserves the right to alter the characteristics of products without notice. The values shown are nominal, with a +/- 1% tolerance for size, depending on the material, and a +/- 3% for weight.

Version A **600 x 400 mm H 225 mm**  
 Version I **600 x 400 mm H 230 mm**  
 Version Z **600 x 400 mm H 240 mm**



	ARTICLE	BOTTOM WALLS HANDLES	SUPPORTS FOR STACKING	HINGED LID	GR.	PACKAGING		UNIT PRICE €
						Qté par paq.	Qté par palette	
♻️ PP	A DE 6422A 5701	■			1706	5	136	
♻️ PP	I DE 6422I 5701	■	■		1922	5	136	
♻️ PP	Z DE 6422Z 5701	■		■	2606	5	104	
ACCESSORIES								
♻️ PP	1 DE 64SE 5701				960	1	160	
♻️ PP	2 DE SEAL 5113					500		

A - I	
Stacked edge height	50 mm
Usable height with lid	215 mm
Usable internal dimensions at the base	500 x 330 x 220 H mm
Volume	38 L
Pieces per pack / pallet	📦 5 🚚 136
Package dimensions	620 x 420 x 445 H mm
Pallet dimensions	1220 x 800 x 2005 H mm
Z	
Stacked edge height	90 mm
Usable H.	215 mm
Usable internal dimensions at the base	500 x 330 x 220 H mm
Volume	38 L
Pieces per pack / pallet	📦 5 🚚 104
Package dimensions	630 x 510 x 513 H mm
Pallet dimensions	1300 x 1000 x 1946 H mm
1	
Lid nominal measurement	600 x 400 mm
Pieces per pack. / dimension	📦 1 / 610 x 410 x 30 H mm
Pieces per pallet / dimension	🚚 160 / 1220x800x1000Hmm
2	
Disposable security seal	
Pieces per pack	📦 500

DATASHEET

iMilani srl reserves the right to alter the characteristics of products without notice. The values shown are nominal, with a +/- 1% tolerance for size, depending on the material, and a +/- 3% for weight.

**600 x 400 mm H 275 mm** Version A  
**600 x 400 mm H 280 mm** Version I  
**600 x 400 mm H 290 mm** Version Z

iMICUBE

DELTA

111

DE

	ARTICLE	BOTTOM WALLS HANDLES	SUPPORTS FOR STACKING	HINGED LID	GR.	PACKAGING		UNIT PRICE €
						Qté par paq.	Qté par palette	
A	DE 6427A 5701	■			2110	5	104	
I	DE 6427I 5701	■	■		2326	5	104	
Z	DE 6427Z 5701	■		■	2606	5	80	
ACCESSORIES								
1	DE 64SE 5701				960	1	160	
2	DE SEAL 5113					500		

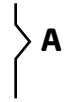

Closed bottom  
Load capacity 20 kg

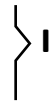

Closed bottom  
Load capacity 20 kg

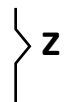

Closed bottom  
Load capacity 20 kg

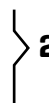
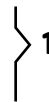

DATASHEET

A-I

Stacked edge height	65 mm
Usable height with lid	265 mm
Usable internal dimensions at the base	500 x 330 x 270 H mm
Volume	48 L
Pieces per pack / pallet	📦 5 🚚 104
Package dimensions	620 x 420 x 555 H mm
Pallet dimensions	1220 x 800 x 2030 H mm

Z

Stacked edge height	105 mm
Usable H.	265 mm
Usable internal dimensions at the base	500 x 330 x 270 H mm
Volume	45 L
Pieces per pack / pallet	📦 5 🚚 80
Package dimensions	630 x 510 x 623 H mm
Pallet dimensions	1300 x 1000 x 1903 H mm

1

Lid nominal measurement	600 x 400 mm
Pieces per pack. / dimension	📦 1 / 610 x 410 x 30 H mm
Pieces per pallet / dimension	🚚 160 / 1220x800x1000H mm

2

Disposable security seal	
Pieces per pack	📦 500

iMilani srl reserves the right to alter the characteristics of products without notice. The values shown are nominal, with a +/- 1% tolerance for size, depending on the material, and a +/- 3% for weight.

Version A **600 x 400 mm H 325 mm**  
 Version I **600 x 400 mm H 330 mm**  
 Version Z **600 x 400 mm H 340 mm**

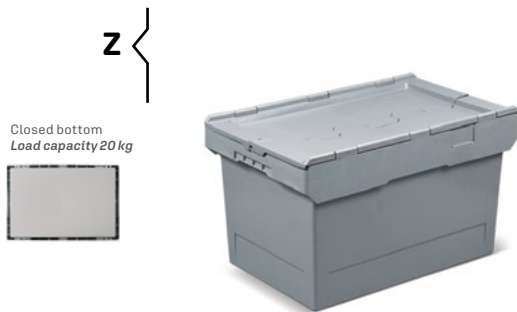

	ARTICLE	BOTTOM WALLS HANDLES	SUPPORTS FOR STACKING	HINGED LID	GR.	PACKAGING		UNIT PRICE €
						Qté par paq.	Qté par palette	
	A DE 6432A 5701	■			2270	4	80	
	I DE 6432I 5701	■	■		2486	4	80	
	Z DE 6432Z 5701	■		■	3170	3	76	
<b>ACCESSORIES</b>								
	1 DE 64SE 5701				960	1	160	
	2 DE SEAL 5113					500		

A - I	
Stacked edge height	80 mm
Usable height with lid	315 mm
Usable internal dimensions at the base	500 x 330 x 320 H mm
Volume	58 L
Pieces per pack / pallet	4  80
Package dimensions	620 x 420 x 585 H mm
Pallet dimensions	1220 x 800 x 1975 H mm
Z	
Stacked edge height	120 mm
Usable H.	315 mm
Usable internal dimensions at the base	500 x 330 x 320 H mm
Volume	58 L
Pieces per pack / pallet	3  76
Package dimensions	630 x 510 x 640 H mm
Pallet dimensions	1300 x 1000 x 2145 H mm
1	
Lid nominal measurement	600 x 400 mm
Pieces per pack. / dimension	1 / 610 x 410 x 30 H mm
Pieces per pallet / dimension	160 / 1220x800x1000Hmm
2	
Disposable security seal	
Pieces per pack	500

DATASHEET



**600 x 400 mm H 425 mm** Version A  
**600 x 400 mm H 430 mm** Version I  
**600 x 400 mm H 440 mm** Version Z

iMICUBE

6442

DELTA

113

DE

	ARTICLE	BOTTOM WALLS HANDLES	SUPPORTS FOR STACKING	HINGED LID	GR.	PACKAGING		UNIT PRICE €
						Qté par paq.	Qté par palette	
A	DE 6442A 5701	■			2890	3	64	
I	DE 6442I 5701	■	■		3106	3	64	
Z	DE 6442Z 5701	■		■	3790	3	56	
ACCESSORIES								
1	DE 64SE 5701				960	1	160	
2	DE SEAL 5113					500		

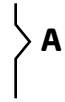

Closed bottom  
Load capacity 20 kg

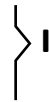

Closed bottom  
Load capacity 20 kg

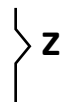

Closed bottom  
Load capacity 20 kg

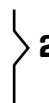
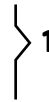

DATASHEET

A-I

Stacked edge height	100 mm
Usable height with lid	415 mm
Usable internal dimensions at the base	500 x 330 x 420 H mm
Volume	74 L
Pieces per pack / pallet	3 64
Package dimensions	620 x 420 x 645 H mm
Pallet dimensions	1220 x 800 x 2055 H mm

Z

Stacked edge height	140 mm
Usable H.	415 mm
Usable internal dimensions at the base	500 x 330 x 420 H mm
Volume	74 L
Pieces per pack / pallet	3 56
Package dimensions	630 x 510 x 687 H mm
Pallet dimensions	1300 x 1000 x 2040 H mm

1

Lid nominal measurement	600 x 400 mm
Pieces per pack. / dimension	1 / 610 x 410 x 30 H mm
Pieces per pallet / dimension	160 / 1220x800x1000H mm

2

Disposable security seal	
Pieces per pack	500

iMilani srl reserves the right to alter the characteristics of products without notice. The values shown are nominal, with a +/- 1% tolerance for size, depending on the material, and a +/- 3% for weight.

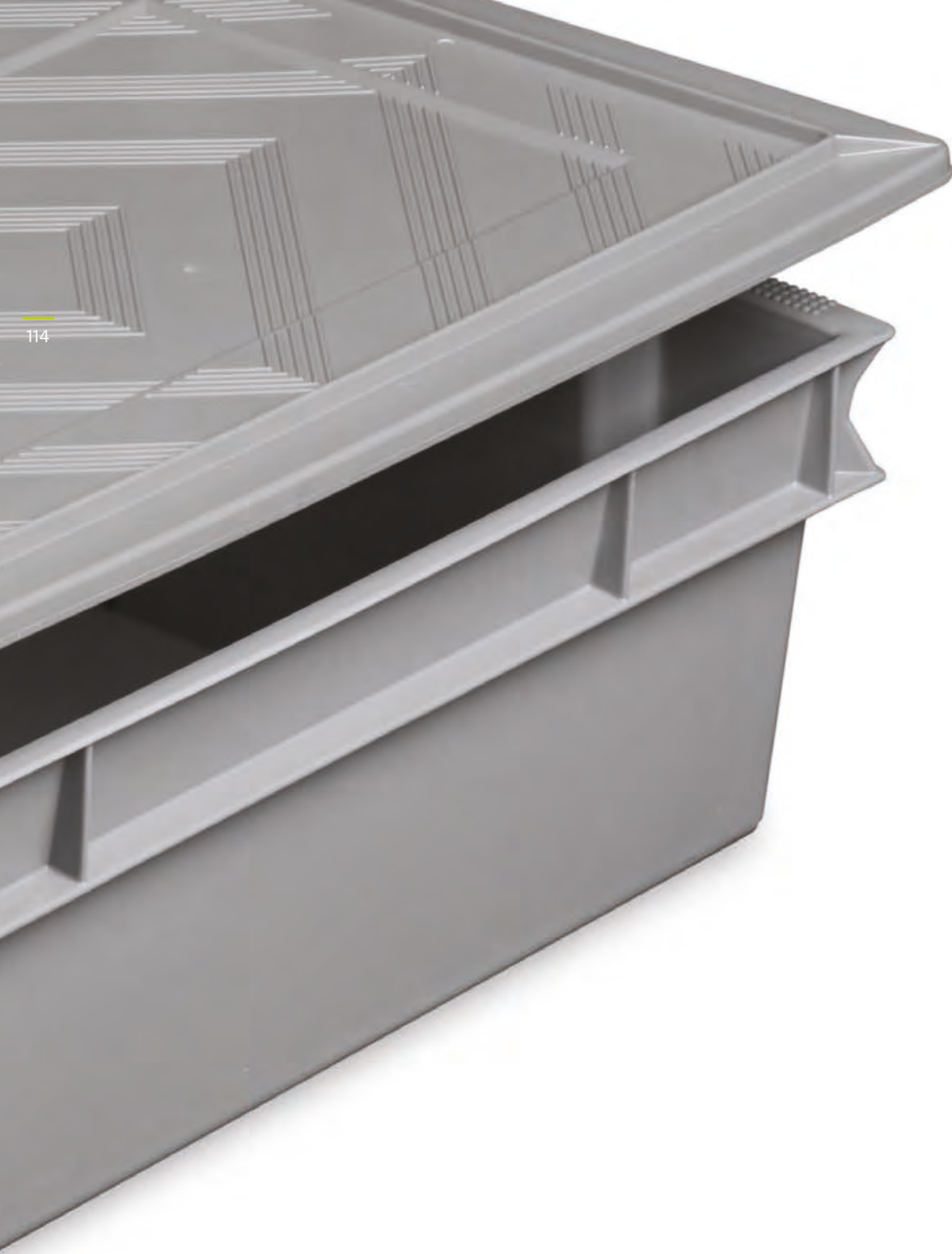

114



# MINERVA

Boxes in the **MINERVA** series have a truncated cone structure, allowing for stable and safe stacking at full load. When empty they can be inserted one inside the other, resulting in a 60% reduction in volume.

These properties make them perfect for maximising

warehouse space and transport space. They are particularly useful in shipment returns when empty or when packaging must take up the least possible space.

## HANDLES

open handle



## WALLS

closed walls



perforated walls



## BOTTOMS

1MICUBE

closed bottom



perforated bottom



The Minerva series boxes have asymmetrical wall geometry. This characteristic means that, without having to use the lid, you can create a stack when they are empty, or when they are full by simply rotating the box by 180°; they can thus be nested when empty or stacked when full.

When the separate lid is used, however, stacking of the full box does not require any rotation.

Boxes stacked with lid



Boxes stacked without lid

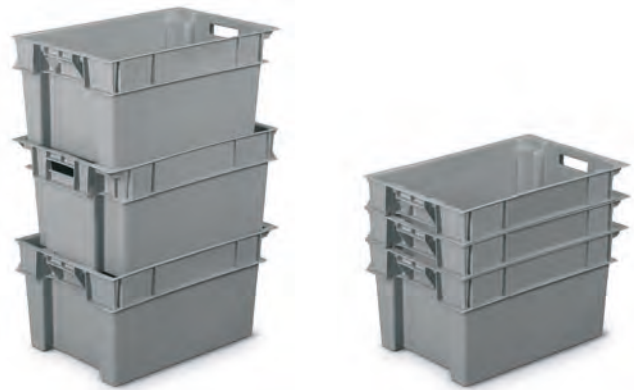



	ARTICLE	WALLS		BOTTOM			HANDLES		GR.	PACKAGING		UNIT PRICE €
		Closed	Perforated	Closed	Perforated	Reinforced	Closed	Open		Qty. per pack.	Qty. per pallet	
<b>B</b>	MI 6420B 5101	-		-			-	-	1650	6	128	
	MI 6420B 5900	-		-			-	-	1650	6	128	
<b>S</b>	MI 6420S 5101		-		-			-	1502	6	128	
	MI 6420S 5900		-		-			-	1502	6	128	
<b>ACCESSORIES</b>												
<b>1</b>	MI 64SE 5101								1000	1	160	
	MI 64SE 5900								1000	1	160	
<b>2</b>	SPRING 0099									10		
<b>3</b>	MI LOCK 0099									10		



**B**  
Closed bottom  
Load capacity 20 kg



**S**  
Perforated bottom  
Capacité 20 kg



**1**



**2**



**3**

DATASHEET

<b>B-S</b>	
Stacked edge height	60 mm
Usable stacked height / with lid	178 mm / 195 mm
Usable internal dimensions	453 x 336 x 197 H mm
Volume	32 L
Pieces per pack / pallet	6 / 128
Package dimensions	620 x 420 x 520 H mm
Pallet dimensions	1200 x 800 x 2210 H mm
<b>1</b>	
Lid nominal measurement	600 x 400 mm
Pieces per pack. / dimension	1 / 610 x 410 x 30 H mm
Pieces per pallet / dimension	160 / 1230 x 820 x 950 H mm
<b>2</b>	
Labels and document holder spring	
Pieces per pack	10
<b>3</b>	
Lid holder spring	
Pieces per pack	10

iMilani srl reserves the right to alter the characteristics of products without notice. The values shown are nominal, with a +/- 1% tolerance for size, depending on the material, and a +/- 3% for weight.

Closed bottom  
Load capacity 20 kg



Perforated bottom  
Capacité 20 kg

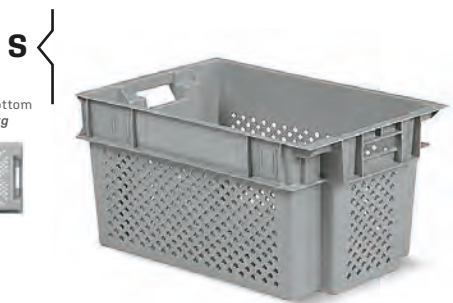

ARTICLE	WALLS		BOTTOM			HANDLES		GR.	PACKAGING		UNIT PRICE €
	Closed	Perforated	Closed	Perforated	Reinforced	Closed	Open		Qty. per pack.	Qty. per pallet	
<b>B</b> MI 6430B5101	-		-			-		2432	4	88	
MI 6430B5900	-		-			-		2432	4	88	
<b>S</b> MI 6430S5101		-		-				2294	4	88	
MI 6430S5900		-		-				2294	4	88	
ACCESSORIES											
<b>1</b> MI 64SE 5101								1000	1	160	
MI 64SE 5900								1000	1	160	
<b>2</b> SPRING 0099									10		
<b>3</b> MI LOCK 0099									10		

**B-S**

Stacked edge height	86 mm
Usable stacked height / with lid	272 mm / 295 mm
Usable internal dimensions	453 x 336 x 297 H mm
Volume	50 L
Pieces per pack / pallet	📦 4 🚚 88
Package dimensions	620 x 420 x 578 H mm
Pallet dimensions	1200 x 800 x 2256 H mm

**1**

Lid nominal measurement	600 x 400 mm
Pieces per pack. / dimension	📦 1 / 610 x 410 x 30 H mm
Pieces per pallet / dimension	🚚 160 / 1230 x 820 x 950 H mm

**2**

Labels and document holder spring	
Pieces per pack	📦 10

**3**

Lid holder spring	
Pieces per pack	📦 10

# 600 x 400 mm H 400 mm

iMICUBE

	ARTICLE	WALLS		BOTTOM			HANDLES		GR.	PACKAGING		UNIT PRICE €
		Closed	Perforated	Closed	Perforated	Reinforced	Closed	Open		Qty. per pack.	Qty. per pallet	
<b>B</b>	MI 6440B5101	-		-			-	-	2865	3	60	
	MI 6440B5900	-		-			-	-	2865	3	60	
<b>S</b>	MI 6440S5101	-		-			-	-	2654	3	60	
	MI 6440S5900	-		-			-	-	2654	3	60	
<b>ACCESSORIES</b>												
<b>1</b>	MI 64SE 5101								1000	1	160	
	MI 64SE 5900								1000	1	160	
<b>2</b>	SPRING 0099									10		
<b>3</b>	MI LOCK 0099									10		



**B**  
Closed bottom  
Load capacity 20 kg



**S**  
Perforated bottom  
Capacité 20 kg

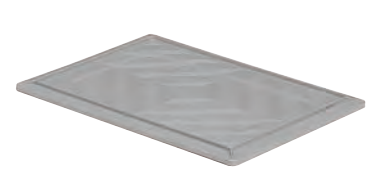

**1**

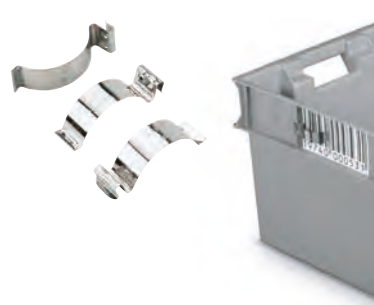

**2**



**3**

## DATASHEET

<b>B-S</b>	
Stacked edge height	117 mm
Usable stacked height / with lid	372 mm / 395 mm
Usable internal dimensions	453 x 336 x 397 H mm
Volume	70 L
Pieces per pack / pallet	📦 3 🚚 60
Package dimensions	620 x 420 x 654 H mm
Pallet dimensions	1200 x 800 x 2188 H mm
<b>1</b>	
Lid nominal measurement	600 x 400 mm
Pieces per pack. / dimension	📦 1 / 610 x 410 x 30 H mm
Pieces per pallet / dimension	🚚 160 / 1230x820x950 H mm
<b>2</b>	
Labels and document holder spring	
Pieces per pack	📦 10
<b>3</b>	
Lid holder spring	
Pieces per pack	📦 10

iMilani srl reserves the right to alter the characteristics of products without notice. The values shown are nominal, with a +/- 1% tolerance for size, depending on the material, and a +/- 3% for weight.



120



# COMPAT

The **COMPAT** container series is the ideal solution to any storage problems in the warehouse, workshop or on assembly lines. They allow you to have the contents always at hand and in full view, making them easily extractable.

These containers can be stacked stably and safely and the material is just as easily accessible even when they are one on top of the other.



## BOTTOMS

1MICUBE

smooth bottom



ribbed bottom



bottom ribbed at 45° with crossbar

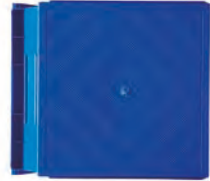

## CROSSBAR



The largest containers are equipped with a frontal crossbar that helps prevent any deformation of the side walls due to large loads and to facilitate grip.

## HANDLES



Lifting and transport are aided by convenient handles that allow for quick grip even with gloves.

## SIDE REINFORCEMENT



Lateral reinforcement on the bottom allows the containers to be stacked safely even when fully loaded.

## ACCESSORIES













The containers can be divided longitudinally and transversely for load units with multiple products inside them.



Practical transparent doors protect against dust.



Internal partition with removable boxes

ARTICLE	SMOOTH BOTTOM	SIZE 01	SIZE 0	GR.	PACKAGING		UNIT PRICE €
					Qty. per pack.	Qty. per pallet	
	Closed						
 CO Z001 5101	"	"		18	100	-	
 CO Z001 5102	"	"		18	100	-	
<b>A</b>  CO Z001 5103	"	"		18	100	-	
 CO Z001 5104	"	"		18	100	-	
 CO Z001 5105	"	"		18	100	-	
 CO Z000 5101	"		"	38	98	-	
 CO Z000 5102	"		"	38	98	-	
<b>B</b>  CO Z000 5103	"		"	38	98	-	
 CO Z000 5104	"		"	38	98	-	
 CO Z000 5105	"		"	38	98	-	
 CO Z000 5207	"		"	43	98	-	
<b>C</b> LB 4911 8001	"		"		1		

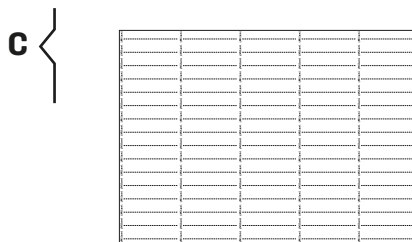
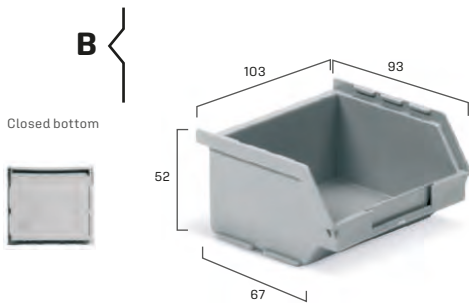
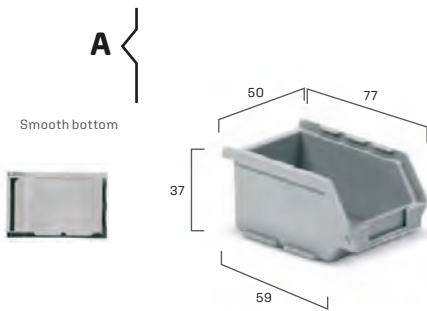

A	
Volume	0,08 L
Pieces per pack	📦 100
Package dimensions	350 x 270 x 170 H mm
B	
Volume	0,25 L
Pieces per pack	📦 98
Package dimensions	470 x 300 x 350 H mm
C	
Sheet of 80 labels for size 0	49 x 11 H mm

DATASHEET

ARTICLE	SMOOTH BOTTOM	SIZE 1	SIZE 2	GR.	PACKAGING		UNIT PRICE €	
					Qty. per pack.	Qty. per pallet		
CO C001 5101	"	"	"	78	50	1750		♻️
CO C001 5102	"	"	"	78	50	1750		♻️
CO C001 5103	"	"	"	78	50	1750		♻️
<b>A</b> CO C001 5104	"	"	"	78	50	1750		♻️
CO C001 5105	"	"	"	78	50	1750		♻️
CO C001 5401	"	"	"	82	50	1750		♻️ ECOGREEN
CO C001 5207	"	"	"	87	50	1750		♻️
CO C002 5101	"	"	"	214	54	1080		♻️
CO C002 5102	"	"	"	214	54	1080		♻️
CO C002 5103	"	"	"	214	54	1080		♻️
<b>B</b> CO C002 5104	"	"	"	214	54	1080		♻️
CO C002 5105	"	"	"	214	54	1080		♻️
CO C002 5207	"	"	"	240	54	1080		♻️
CO C002 5401	"	"	"	224	54	1080		♻️ ECOGREEN
CO C1S2 5407	"	"	"	40	25	-		♻️ ECOGREEN
CO C1S2 5207	"	"	"	45	25	-		♻️
CO C2S2 5407	"	"	"	100	25	-		♻️ ECOGREEN
CO C2S2 5207	"	"	"	112	25	-		♻️
CO C1S4 5407	"	"	"	50	25	-		♻️ ECOGREEN
CO C1S4 5207	"	"	"	56	25	-		♻️
<b>D</b> CO C2S4 5407	"	"	"	120	25	-		♻️ ECOGREEN
CO C2S4 5207	"	"	"	134	25	-		♻️
<b>E</b> LB 7520 3601	"	"	"		1			
LB 10433 1601	"	"	"		1			

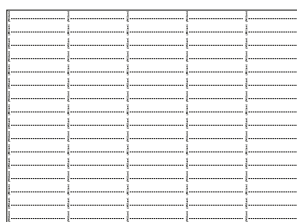
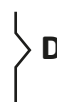
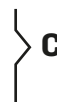
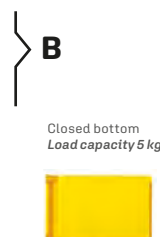
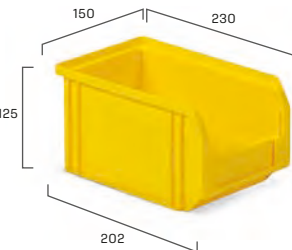
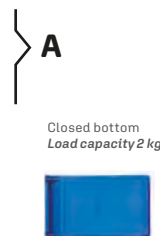
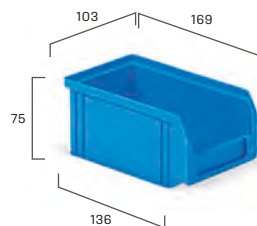

DATASHEET

A	
Volume	1 L
Pieces per pack / pallet	50 1750
Package dimensions	520 x 350 x 370 H mm
Pallet dimensions	1300 x 1100 x 2000 H mm
B	
Volume	3,8 L
Pieces per pack / pallet	54 1080
Package dimensions	720 x 460 x 500 H mm
Pallet dimensions	1450 x 1200 x 2100 H mm
C	
Divider 2 compartments for size 1	
Divider 2 compartments for size 2	
D	
Divider 4 compartments for size 1	
Divider 4 compartments for size 2	
E	
Sheet of 36 labels for size 1	75 x 20 H mm
Sheet of 16 labels for size 2	104 x 33 H mm

iMilani srl reserves the right to alter the characteristics of products without notice. The values shown are nominal, with a +/- 1% tolerance for size, depending on the material, and a +/- 3% for weight.

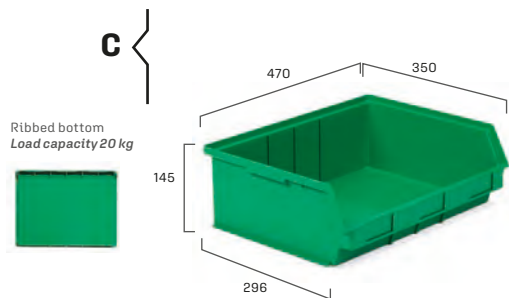
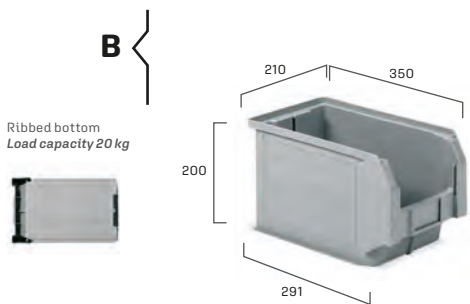
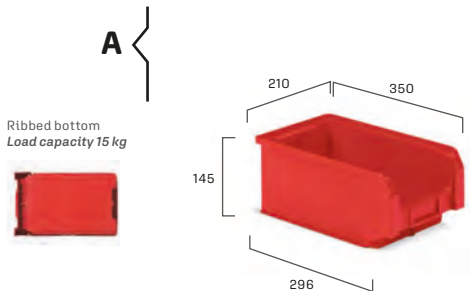

ARTICLE	RIBBED BOTTOM	SIZE 3A2	SIZE 3	SIZE 3L5	GR.	PACKAGING		UNIT PRICE €
						Qty. per pack.	Qty. per pallet	
CO C3A2 5101	PP	"	"			598	21 252	
CO C3A2 5102	PP	"	"			598	21 252	
CO C3A2 5103	PP	"	"			598	21 252	
<b>A</b> CO C3A2 5104	PP	"	"			598	21 252	
CO C3A2 5105	PP	"	"			598	21 252	
ECOGREEN CO C3A2 5401	PP	"	"			625	21 252	
CO C3A2 5207	PP	"	"			670	21 252	
CO C003 5101	PP		"			784	15 180	
CO C003 5102	PP		"			784	15 180	
CO C003 5103	PP		"			784	15 180	
<b>B</b> CO C003 5104	PP		"			784	15 180	
CO C003 5105	PP		"			784	15 180	
ECOGREEN CO C003 5401	PP		"			819	15 180	
CO C003 5207	PP		"			878	15 180	
CO Z3L5 5101	PP			"		1074	14 112	
CO Z3L5 5102	PP			"		1074	14 112	
<b>C</b> CO Z3L5 5103	PP			"		1074	14 112	
CO Z3L5 5104	PP			"		1074	14 112	
CO Z3L5 5105	PP			"		1074	14 112	

A	
Volume	9,4 L
Pieces per pack / pallet	21  252
Package dimensions	360 x 640 x 980 H mm
Pallet dimensions	1300 x 1000 x 2000 H mm

B	
Volume	12,5 L
Pieces per pack / pallet	15  180
Package dimensions	360 x 640 x 980 H mm
Pallet dimensions	1300 x 1000 x 2000 H mm

C	
Volume	19 L
Pieces per pack / pallet	14  112
Package dimensions	710 x 960 x 480 H mm
Pallet dimensions	1450 x 1000 x 2100 H mm

DATASHEET

iMilani srl reserves the right to alter the characteristics of products without notice. The values shown are nominal, with a +/- 1% tolerance for size, depending on the material, and a +/- 3% for weight.

ARTICLE	SIZE 3A2	SIZE 3	SIZE 3L5	GR.	PACKAGING		UNIT PRICE €
					Qty. per pack.	Qty. per pallet	
CD C3A2 0099	"			200	1		
<b>A</b> CD C003 0099		"		300	1		
CD Z3L5 0099			"	250	1		
CD C3A2 7107	"			108	10		
<b>B</b> CD C003 7107		"		160	10		
CD Z3L5 7107			"	114	10		
CW C3A2 6896	"			28	10		
<b>C</b> CW C003 6896		"		40	10		
LH C000 0099	"	"		100	1		
<b>D</b> LB 7731 1801	"		"		1		
LB 7742 1201		"			1		
<b>E</b>							



A



B



C



D

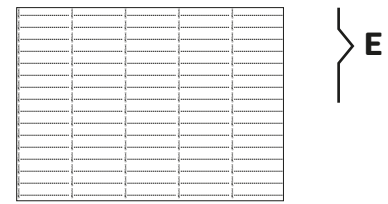

E

DATASHEET

A	
Galvanised longit. divider size 3A2	302 x 105 H mm
Galvanised longit. divider size 3	307 x 160 H mm
Galvanised longit. divider size 3L5	326 x 115 H mm
Pieces per pack	📦 1
B	
Plastic longit. divider size 3A2	300 x 105 H mm
Plastic longit. divider size 3	305 x 160 H mm
Plastic longit. divider size 3L5	325 x 105 H mm
Pieces per pack	📦 10
C	
Dust cover size 3A2	
Dust cover size 3	
Pieces per pack	📦 10
D	
Inclined galvanised tag holder for size 3 - 3A2	100 x 67 mm
Pieces per pack	1
E	
Sheet of 18 labels for size 3A2 - 3L5	77 x 31 mm
Sheet of 12 labels for size 3	77 x 42 mm
Pieces per pack	📦 1

iMilani srl reserves the right to alter the characteristics of products without notice. The values shown are nominal, with a +/- 1% tolerance for size, depending on the material, and a +/- 3% for weight.

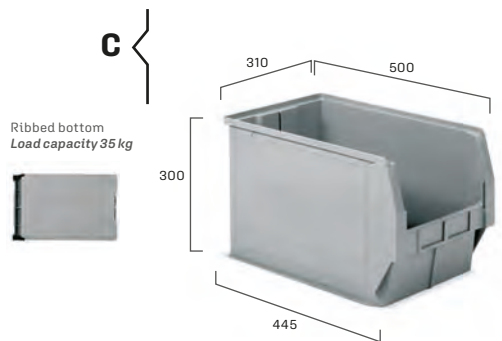
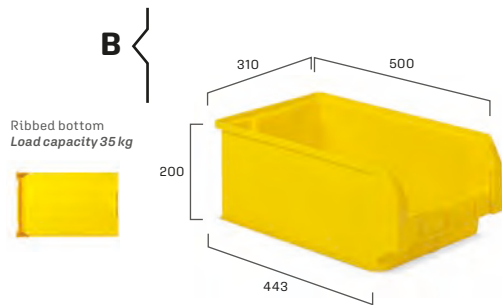
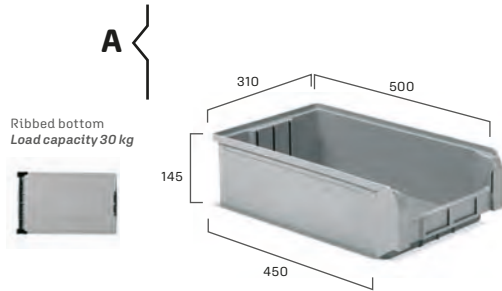

ARTICLE	RIBBED BOTTOM	SIZE 4A2	SIZE 4	SIZE 4A5	GR.	PACKAGING		UNIT PRICE €
						Qty. per pack.	Qty. per pallet	
CO C4A2 5101	PP	"	"		1222	14	112	
CO C4A2 5102	PP	"	"		1222	14	112	
<b>A</b> CO C4A2 5103	PP	"	"		1222	14	112	
CO C4A2 5104	PP	"	"		1222	14	112	
CO C4A2 5105	PP	"	"		1222	14	112	
CO C004 5101	PP		"		1335	10	80	
CO C004 5102	PP		"		1335	10	80	
CO C004 5103	PP		"		1335	10	80	
<b>B</b> CO C004 5104	PP		"		1335	10	80	
CO C004 5105	PP		"		1335	10	80	
CO C004 5401	PP		"		1395	10	80	
CO C004 5207	PP		"		1495	10	80	
CO C4A5 5101	PP			"	1874	6	48	
CO C4A5 5102	PP			"	1874	6	48	
<b>C</b> CO C4A5 5103	PP			"	1874	6	48	
CO C4A5 5104	PP			"	1874	6	48	
CO C4A5 5105	PP			"	1874	6	48	

**A**

Volume	20 L
Pieces per pack / pallet	📦 14 🚚 112
Package dimensions	640 x 520 x 900 H mm
Pallet dimensions	1300 x 1000 x 2150 H mm

**B**

Volume	28 L
Pieces per pack / pallet	📦 10 🚚 80
Package dimensions	640 x 520 x 980 H mm
Pallet dimensions	1300 x 1000 x 2150 H mm

**C**

Volume	42 L
Pieces per pack / pallet	📦 6 🚚 48
Package dimensions	640 x 520 x 900 H mm
Pallet dimensions	1300 x 1000 x 2150 H mm

DATASHEET

	ARTICLE	SIZE 4A2	SIZE 4	SIZE 4A5	GR.	PACKAGING		UNIT PRICE €
						Qty. per pack.	Qty. per pallet	
<b>A</b>	CD C4A2 0099	"			360	1		
	CD C004 0099		"		500	1		
	CD C4A5 0099			"	540	1		
<b>B</b>	CD C004 7107		"		236	10		
	CD C4A5 7107			"	390	10		
<b>C</b>	CD C004 0199		"		368	1		
<b>D</b>	CW C004 6896		"		66	10		
	CW C4A5 6896			"	92	10		
<b>E</b>	LH C000 0099		"	"	100	1		
<b>F</b>	LB 7731 1801	"				1		
	LB 7742 1201		"	"		1		

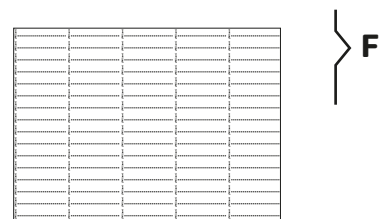

## DATASHEET

### A

Galvanised longit. divider size 4A2	457 x 120 H mm
Galvanised longit. divider size 4	426 x 160 H mm
Galvanised longit. divider size 4A5	460 x 249 H mm
Pieces per pack	☞ 1

### B

Plastic longit. divider size 4	460 x 160 H mm
Plastic longit. divider size 4A5	460 x 250 H mm
Pieces per pack	☞ 10

### C

Pair of galvanised transverse dividers size 4	
Pieces per pack	☞ 1

### D

Dust cover size 4	
Dust cover size 4A5	
Pieces per pack	☞ 10

### E

Inclined galvanised tag holder for size 4 - 4A5	100 x 67 mm
Pieces per pack	1

### F

Sheet 18 labels for size 4A2	77 x 31 mm
Sheet 12 labels for size 4 - 4A5	77 x 42 mm
Pieces per pack	☞ 1

iMilani srl reserves the right to alter the characteristics of products without notice. The values shown are nominal, with a +/- 1% tolerance for size, depending on the material, and a +/- 3% for weight.

	ARTICLE	RIBBED BOTTOM A 45°	SIZE 5P4	SIZE 5	GR.	PACKAGING		UNIT PRICE €
						Qty. per pack.	Qty. per pallet	
A	CO Z5P4 5101	"	"		3370	18	42	
	CO Z5P4 5102	"	"		3370	18	42	
	CO Z5P4 5103	"	"		3370	18	42	
	CO Z5P4 5104	"	"		3370	18	42	
	CO Z5P4 5105	"	"		3370	18	42	
B	CO Z005 5101	"		"	4378	12	28	
	CO Z005 5102	"		"	4378	12	28	
	CO Z005 5103	"		"	4378	12	28	
	CO Z005 5104	"		"	4378	12	28	
	CO Z005 5105	"		"	4378	12	28	

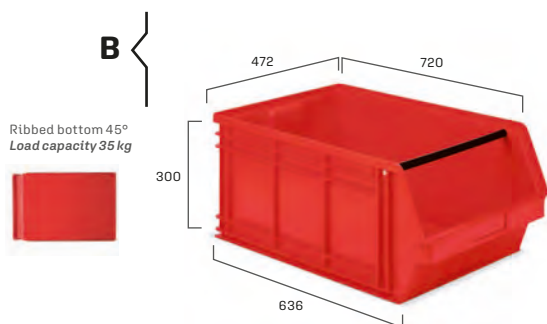
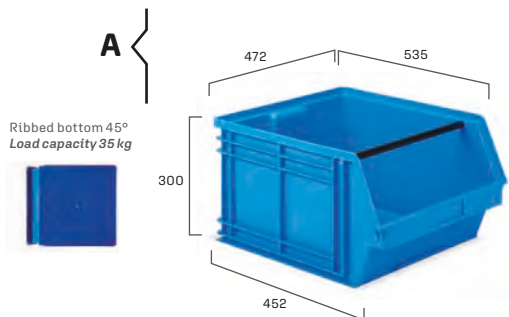

A	
Volume	63 L
Pieces per pack / pallet	📦 18 🚚 42
Package dimensions	1400 x 1100 x 1050 H mm
Pallet dimensions	1400 x 1100 x 2100 H mm

B	
Volume	88 L
Pieces per pack / pallet	📦 12 🚚 28
Package dimensions	1450 x 1000 x 1050 H mm
Pallet dimensions	1450 x 1000 x 2100 H mm

DATASHEET



# Size 5P4 - Size 5

iMICUBE

	ARTICLE	SIZE 5P4	SIZE 5	GR.	PACKAGING		UNIT PRICE €
					Qty. per pack.	Qty. per pallet	
<b>A</b>	CS Z5P4 0199	"		1420	1		
	CS Z005 0199		"	1750	1		
<b>B</b>	CD Z5P4 0099	"		680	1		
	CD Z005 0099		"	1000	1		
<b>C</b>	LH Z000 0099	"	"	150	1		
<b>D</b>	LB 12739 1001	"	"		1		
<b>E</b>	LB 18985 0301	"	"		1		
<b>F</b>	ZE Z002 5101	"	"	264	54	1080	
	ZE Z002 5102	"	"	264	54	1080	
	ZE Z002 5103	"	"	264	54	1080	
	ZE Z002 5104	"	"	264	54	1080	
	ZE Z002 5105	"	"	264	54	1080	

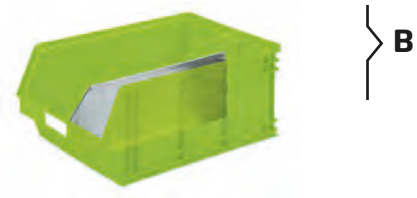

## DATASHEET

A	
Galvanised longit. divider size 5P4 with pair of galvanised transverse supports	473 x 215 H mm
Galvanised longit. divider size 5 with pair of galvanised transverse supports	654 x 214 H mm
Pieces per pack	📦 1 set
B	
Galvanised longit. divider size 5P4	473 x 215 H mm
Galvanised longit. divider size 5	654 x 214 H mm
Pieces per pack	📦 1
C	
Inclined galvanised tag holder for size 5P4 - 5	128 x 90 mm
Pieces per pack	📦 1
D	
Sheet 10 upper labels for size 5P4- 5	127 x 39 mm
Pieces per pack	📦 1
E	
Sheet 3 lower labels for size 5P4-5	189 x 85 mm
Pieces per pack	📦 1
F	
Box for division into 6 compartments size 5P4 and into 8 compartments size 5	200 x 140 x 130 H mm
Volume	88 L
Pieces per pack / pallet	📦 54    📦 1080
Package dimensions	640 x 460 x 500 H mm
Pallet dimensions	1400 x 1100 x 1660 H mm

iMilani srl reserves the right to alter the characteristics of products without notice. The values shown are nominal, with a +/- 1% tolerance for size, depending on the material, and a +/- 3% for weight.



# ZEUS

The **ZEUS** box series meets the most exacting needs for goods containment, handling and storage.

Manageable, lightweight and easy to clean

thanks to a perfectly smooth interior, they have a sturdy edge that allows stable and safe stacking. Stackability combined with high storage capacity results in ideal use of space.

# BOTTOMS

micube

smooth bottom



ribbed bottom



bottom ribbed at 45° with crossbar



# SIDE REINFORCEMENT



Lateral reinforcement on the bottom allows the boxes to be stacked safely even when fully loaded.

# HANDLES - WALLS

closed handle closed walls





ARTICLE	SMOOTH BOTTOM	SIZE 701	SIZE 702	SIZE 272-2	GR.	PACKAGING		UNIT PRICE €	
						Qty. per pack.	Qty. per pallet		
ZE Z701 5101	-	-			66	50	1600		♻️
ZE Z701 5102	-	-			66	50	1600		♻️
ZE Z701 5103	-	-			66	50	1600		♻️
ZE Z701 5104	-	-			66	50	1600		♻️
ZE Z701 5105	-	-			66	50	1600		♻️
ZE Z701 5207	-	-			74	50	1600		♻️
ZE Z702 5101	-		-		106	30	960		♻️
ZE Z702 5102	-		-		106	30	960		♻️
ZE Z702 5103	-		-		106	30	960		♻️
ZE Z702 5104	-		-		106	30	960		♻️
ZE Z702 5105	-		-		106	30	960		♻️
ZE Z702 5207	-		-		119	30	960		♻️
ZE Z002 5101	-			-	264	54	1080		♻️
ZE Z002 5102	-			-	264	54	1080		♻️
ZE Z002 5103	-			-	264	54	1080		♻️
ZE Z002 5104	-			-	264	54	1080		♻️
ZE Z002 5105	-			-	264	54	1080		♻️
ZE Z002 5207	-			-	296	54	1080		♻️

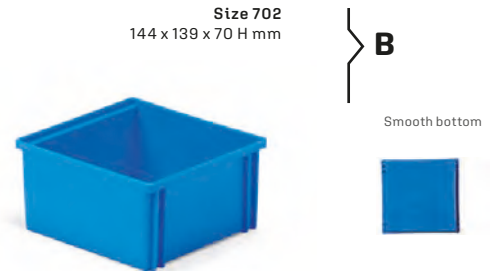

DATASHEET

**A**

Stacked edge height	65 mm
Usable stacked height / Volume	63 mm / 0,9 L
Dimensions	144 x 91 x 70 H mm
Usable internal dimensions	123 x 81 x 68 H mm
Pieces per pack / pallet	📦 50 🚚 1600
Package dimensions	470 x 300 x 350 H mm
Pallet dimensions	1200 x 1000 x 1550 H mm

**B**

Stacked edge height	65 mm
Usable stacked height / Volume	63 mm / 1,4 L
Dimensions	144 x 139 x 70 H mm
Usable internal dimensions	124 x 126 x 68 H mm
Pieces per pack / pallet	📦 30 🚚 960
Package dimensions	470 x 300 x 350 H mm
Pallet dimensions	1200 x 1000 x 1550 H mm

**C**

Stacked edge height	112 mm
Usable stacked height / Volume	110 mm / 3,6 L
Dimensions	211 x 148 x 126 H mm
Usable internal dimensions	187 x 125 x 124 H mm
Pieces per pack / pallet	📦 54 🚚 1080
Package dimensions	720 x 460 x 500 H mm
Pallet dimensions	1450 x 1200 x 2100 H mm

iMilani srl reserves the right to alter the characteristics of products without notice. The values shown are nominal, with a +/- 1% tolerance for size, depending on the material, and a +/- 3% for weight.

# Size 272-3A2 - Size 272-4A2 - Size 272-4

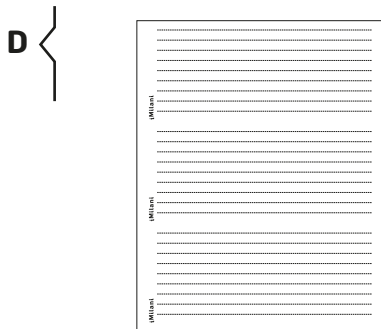
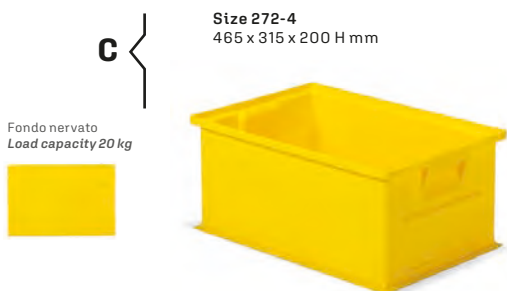

ARTICLE	RIBBED BOTTOM	SIZE 272-3A2	SIZE 272-4A2	SIZE 272-4	GR.	PACKAGING		UNIT PRICE €
						Qty. per pack.	Qty. per pallet	
ZE Z3A2 5101	-	-			522	21	252	
ZE Z3A2 5102	-	-			522	21	252	
<b>A</b> ZE Z3A2 5103	-	-			522	21	252	
ZE Z3A2 5104	-	-			522	21	252	
ZE Z3A2 5105	-	-			522	21	252	
ZE Z3A2 5207	-	-			585	21	252	
ZE Z4A2 5101	-		-		972	16	128	
ZE Z4A2 5102	-		-		972	16	128	
<b>B</b> ZE Z4A2 5103	-		-		972	16	128	
ZE Z4A2 5104	-		-		972	16	128	
ZE Z4A2 5105	-		-		972	16	128	
ZE Z4A2 5207	-		-		1089	16	128	
ZE Z004 5101	-			-	1270	10	80	
ZE Z004 5102	-			-	1270	10	80	
<b>C</b> ZE Z004 5103	-			-	1270	10	80	
ZE Z004 5104	-			-	1270	10	80	
ZE Z004 5105	-			-	1270	10	80	
ZE Z004 5207	-			-	1422	10	80	
<b>D</b> LB 18292 0301			-			1		
LB 18985 0301				-		1		

A	
Stacked edge height	132 mm
Usable stacked height / Volume	130 mm / 8,7 L
Dimensions	310 x 210 x 145 H mm
Usable internal dimensions	284 x 184 x 142 H mm
Pieces per pack / pallet	21  252
Package dimensions	360 x 640 x 980 H mm
Pallet dimensions	1350 x 1100 x 2110 H mm
B	
Stacked edge height	107 mm
Usable stacked height / Volume	105 mm / 16,2 L
Dimensions	465 x 315 x 120 H mm
Usable internal dimensions	423 x 275 x 118 H mm
Pieces per pack / pallet	16  128
Package dimensions	640 x 520 x 900 H mm
Pallet dimensions	1300 x 1000 x 2150 H mm
C	
Stacked edge height	183 mm
Usable stacked height / Volume	181 mm / 27 L
Dimensions	465 x 315 x 200 H mm
Usable internal dimensions	423 x 277 x 195 H mm
Pieces per pack / pallet	10  80
Package dimensions	640 x 520 x 980 H mm
Pallet dimensions	1300 x 1000 x 2150 H mm
D	
Sheet of 3 labels for size 272-4A2	182 x 92 H mm
Sheet of 3 labels for size 272-4	189 x 85 H mm

DATASHEET

iMilani srl reserves the right to alter the characteristics of products without notice. The values shown are nominal, with a +/- 1% tolerance for size, depending on the material, and a +/- 3% for weight.

# Size 272-4A5 - Size 272-5

ARTICLE	RIBBED BOTTOM 45°	SIZE 272-4A5	SIZE 272-5	GR.	PACKAGING		UNIT PRICE €	
					Qty. per pack.	Qty. per pallet		
ZE Z4A5 5101	-	-	-	1824	6	48		
ZE Z4A5 5102	-	-	-	1824	6	48		
<b>A</b> ZE Z4A5 5103	-	-	-	1824	6	48		
ZE Z4A5 5104	-	-	-	1824	6	48		
ZE Z4A5 5105	-	-	-	1824	6	48		
ZE Z005 5101	-	-	-	4355	3	28		
ZE Z005 5102	-	-	-	4355	3	28		
<b>B</b> ZE Z005 5103	-	-	-	4355	3	28		
ZE Z005 5104	-	-	-	4355	3	28		
ZE Z005 5105	-	-	-	4355	3	28		
<b>C</b> LB 18985 0301	-	-	-		1			

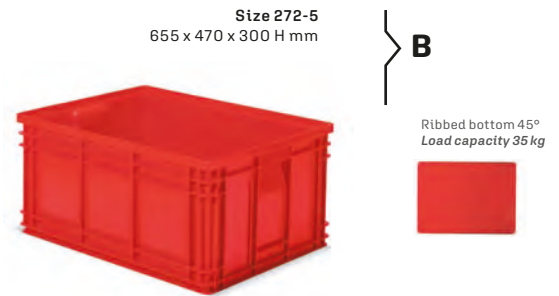

## DATASHEET

**A**

Stacked edge height	285 mm
Usable stacked height / Volume	283 mm / 40,5 L
Dimensions	465 x 315 x 300 H mm
Usable internal dimensions	426 x 276 x 297 H mm
Pieces per pack / pallet	6  48
Package dimensions	640 x 520 x 900 H mm
Pallet dimensions	1300 x 1000 x 2150 H mm

**B**

Stacked edge height	278 mm
Usable stacked height / Volume	276 mm / 85 L
Dimensions	655 x 470 x 300 H mm
Usable internal dimensions	604 x 429 x 297 H mm
Pieces per pack / pallet	3  28
Package dimensions	675 x 490 x 900 H mm
Pallet dimensions	1300 x 1000 x 2150 H mm

**C**

Sheet of 3 labels for size 272-4A5 and 272-5	189 x 85 H mm
--	---------------

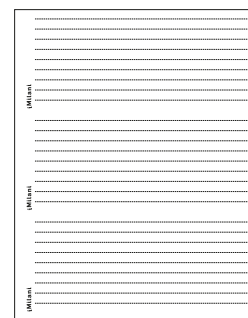



# PRACTIBOX



The **PRACTIBOX** series of drawer units consists of grey ABS structures and high mechanical strength drawers in transparent polystyrene.

Available in models of different depth and height, they share a standard 600 mm width that allows stacking in a wide range of combinations.



## DRAWERS



The drawers, made in high mechanical strength transparent polystyrene, are housed in the ABS container, designed to be positioned on Practibox shelves and in trolleys or fixed to the wall with anchor bolts.

## STACKING



Practibox drawer units are available in different depths and heights but have a standard width of 600 mm. This features means that modules of the same depth or lesser depth can be stacked, allowing a wide range of combinations.

## TILTED OPENING









Equipped with a handy tilting door opening, Practibox drawer units offer excellent access to the product.

## ORDER









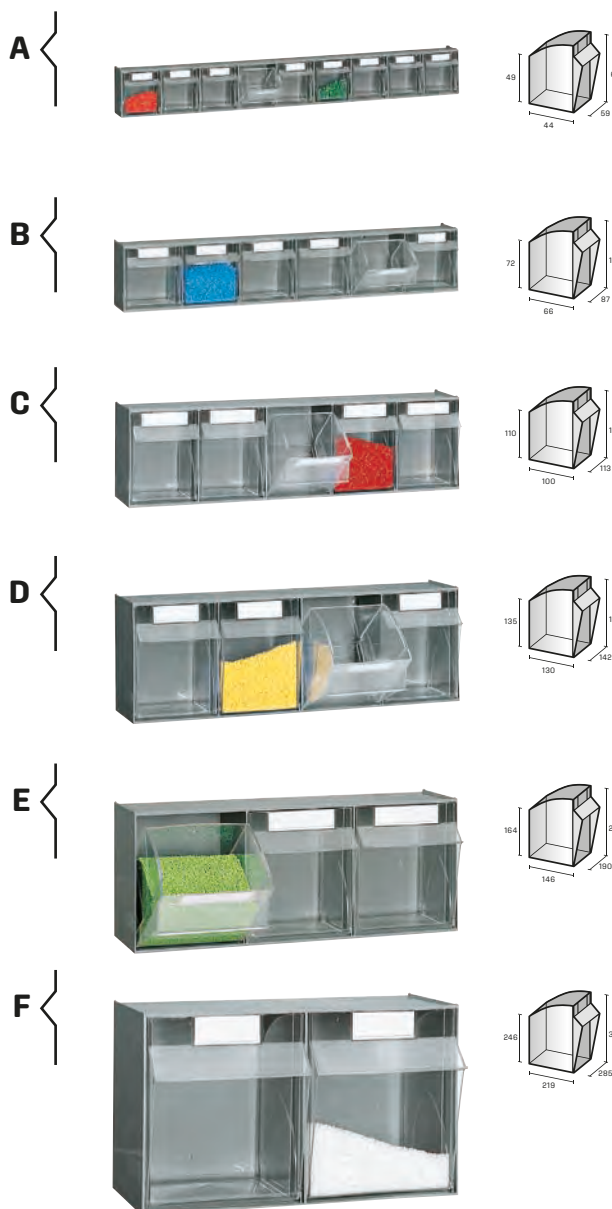





Equipped with a practical handle, Practibox drawer units meet the most varied needs.

# Module width 600 mm

ARTICLE	WIDTH	DEPTH	HEIGHT	NUMBER OF TILTING DRAWERS	PACKAGING		UNIT PRICE €
					Qty. per pack.	Qty. per pallet	
 <b>A</b> PR 9077 0001 LB 03510 0901	600	69	77	9	2	468	
					10		
 <b>B</b> PR 6112 0001 LB 05315 0601	600	98	112	6	2	216	
					10		
 <b>C</b> PR 5164 0001 LB 08022 0501	600	141	164	5	1	120	
					10		
 <b>D</b> PR 4206 0001 LB 08028 0401	600	174	206	4	1	80	
					10		
 <b>E</b> PR 3240 0001 LB 12134 0301	600	209	240	3	1	56	
					10		
 <b>F</b> PR 2353 0001 LB 12150 0201	600	311	353	2	1	30	
					10		



A - 9 drawers		
Pieces per pack / pallet	 2	 468
Package dimensions	610 x 155 x 95 H mm	
Pallet dimensions	1300 x 1000 x 1600 H mm	
LB035100901	Sheet of 9 labels included	
B - 6 drawers		
Pieces per pack / pallet	 2	 216
Package dimensions	610 x 210 x 125 H mm	
Pallet dimensions	1300 x 1000 x 1600 H mm	
LB053150601	Sheet of 6 labels included	
C - 5 drawers		
Pieces per pack / pallet	 1	 120
Package dimensions	610 x 155 x 175 H mm	
Pallet dimensions	1300 x 1000 x 2000 H mm	
LB080220501	Sheet of 5 labels included	
D - 4 drawers		
Pieces per pack / pallet	 1	 80
Package dimensions	610 x 155 x 175 H mm	
Pallet dimensions	1300 x 1000 x 2000 H mm	
LB080280401	Sheet of 4 labels included	
E - 3 drawers		
Pieces per pack / pallet	 1	 56
Package dimensions	610 x 225 x 255 H mm	
Pallet dimensions	1300 x 1000 x 2000 H mm	
LB121340301	Sheet of 3 labels included	
F - 2 drawers		
Pieces per pack / pallet	 1	 30
Package dimensions	610 x 325 x 365 H mm	
Pallet dimensions	1300 x 1000 x 2000 H mm	
LB121500201	Sheet of 2 labels included	

DATASHEET

iMilani srl reserves the right to alter the characteristics of products without notice. The values shown are nominal, with a +/- 1% tolerance for size, depending on the material, and a +/- 3% for weight.

# Module width 610 mm

iMICUBE

	ARTICLE	WIDTH	DEPTH	HEIGHT	NUMBER OF TILTING DRAWERS	PACKAGING		UNIT PRICE €
						Qty. per pack.	Qty. per pallet	
<b>A</b>	PRD050 015 0301	610	174	500	15	1	-	
<b>B</b>	PR D050 0001	610	150	500	-	1	-	
<b>C</b>	PRT BOX 5104	350	200	465	18	1	-	
<b>D</b>	PR ST90 0099	600				1	-	
	PR ST61 0099	600				1	-	
	PR ST51 0099	600				1	-	
	PR ST42 0099	600				1	-	
	PR ST32 0099	600				1	-	
	PR ST23 0099	600				1	-	

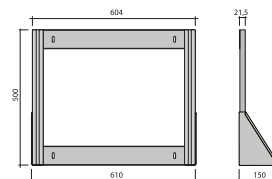

Release system



Galvanized stops

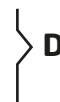

DATASHEET

**A**

Bench frame with drawers	1 x PR D050 0001
Drawers set	1 x PR 6112 0001
	1 x PR 5164 0001
	1 x PR 4206 0001
	1 x PR 4206 0001

**B**

Bench frame without drawers	1 x PR D050 0001
-----------------------------	------------------

**C**

Top Box case	18 drawers type PR 6112 0001
--------------	------------------------------

**D**

Galvanized stop for PR 9077...	1 x PR ST90 0099
Galvanized stop for PR 6112...	1 x PR ST61 0099
Galvanized stop for PR 5164...	1 x PR ST51 0099
Galvanized stop for PR 4206...	1 x PR ST42 0099
Galvanized stop for PR 3240...	1 x PR ST32 0099
Galvanized stop for PR 2353...	1 x PR ST23 0099

iMilani srl reserves the right to alter the characteristics of products without notice. The values shown are nominal, with a +/- 1% tolerance for size, depending on the material, and a +/- 3% for weight.

# Module width 600 mm

ARTICLE	WIDTH	DEPTH	HEIGHT	NUMBER OF TILTING DRAWERS	PACKAGING		UNIT PRICE €
					Qty. per pack.	Qty. per pallet	
A PR F030 0001	600	28	300	-	1	-	
B PR F030036 0101	600	78	308	36	1	-	
C PR F030021 0201	600	107	300	21	1	-	
D PR F030010 0101	600	150	328	10	1	-	

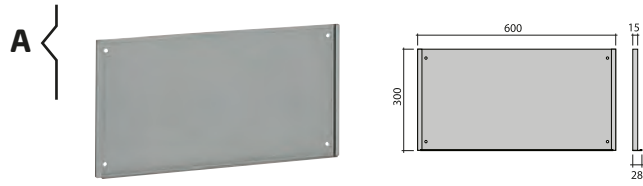

A	
Rear panel	1 x PR F030 0001
B	
Rear panel	1 x PR F030 0001
Drawers set	4 x PR 9077 0001
C	
Rear panel	1 x PR F030 0001
Drawers set	1 x PR 9077 0001
	2 x PR 6112 0001
D	
Rear panel	1 x PR F030 0001
Drawers set	2 x PR 5164 0001

DATASHEET

iMilani srl reserves the right to alter the characteristics of products without notice. The values shown are nominal, with a +/- 1% tolerance for size, depending on the material, and a +/- 3% for weight.

# Module width 600 mm

iMICUBE

ARTICLE	WIDTH	DEPTH	HEIGHT	NUMBER OF TILTING DRAWERS	PACKAGING		UNIT PRICE €
					Qty. per pack.	Qty. per pallet	
<b>A</b> PR F050 0001	600	28	500	-	1	-	
<b>B</b> PR F050054 0101	600	78	500	54	1	-	
<b>C</b> PR F050036 0201	600	107	36	1	-		
<b>D</b> PR F050015 0301	600	183	500	15	1	-	

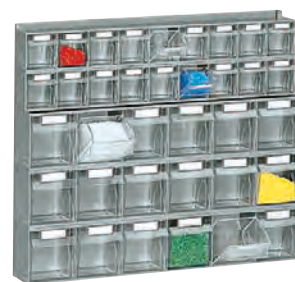
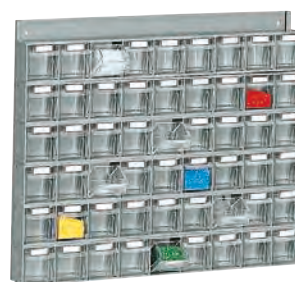
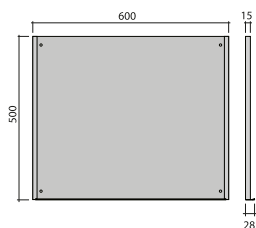

DATASHEET

**A**

Rear panel	1 x PR F050 0001
------------	------------------

**B**

Rear panel	1 x PR F050 0001
Drawers set	6 x PR 9077 0001

**C**

Rear panel	1 x PR F050 0001
Drawers set	2 x PR 9077 0001
	3 x PR 6112 0001

**D**

Rear panel	1 x PR F050 0001
Drawers set	1 x PR 6112 0001
	1 x PR 5164 0001
	1 x PR 4206 0001

iMilani srl reserves the right to alter the characteristics of products without notice. The values shown are nominal, with a +/- 1% tolerance for size, depending on the material, and a +/- 3% for weight.

# Module width 600 mm

ARTICLE	WIDTH	DEPTH	HEIGHT	NUMBER OF TILTING DRAWERS	PACKAGING		UNIT PRICE €
					Qty. per pack.	Qty. per pallet	
<b>A</b> PR F065 0001	600	28	650	-	1	-	
<b>B</b> PR F065072 0101	600	78	650	72	1	-	
<b>C</b> PR F065039 0201	600	107	650	39	1	-	
<b>D</b> PR F065028 0201	600	150	664	28	1	-	



**B**



**A**

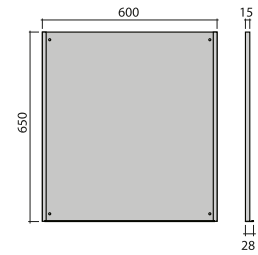

**C**



**D**



A	
Rear panel	1 x PR F065 0001
B	
Rear panel	1 x PR F065 0001
Drawers set	8 x PR 9077 0001
C	
Rear panel	1 x PR F065 0001
Drawers set	1 x PR 9077 0001
	5 x PR 6112 0001
C	
Rear panel	1 x PR F065 0001
Drawers set	3 x PR 6112 0001
	2 x PR 5164 0001

DATASHEET

iMilani srl reserves the right to alter the characteristics of products without notice. The values shown are nominal, with a +/- 1% tolerance for size, depending on the material, and a +/- 3% for weight.

# Module width 600 mm

iMICUBE

ARTICLE	WIDTH	DEPTH	HEIGHT	NUMBER OF TILTING DRAWERS	PACKAGING		UNIT PRICE €
					Qty. per pack.	Qty. per pallet	
<b>A</b> PR F100 0001	600	41	1000	-	1	-	
<b>B</b> PR F100 084 0201	600	113	1022	84	1	-	
<b>C</b> PR F100 054 0101	600	113	1008	54	1	-	
<b>D</b> PR F100 029 0401	600	224	1000	29	1	-	
<b>E</b> PR DBAS 0001	600	300	100		1		

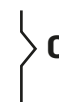
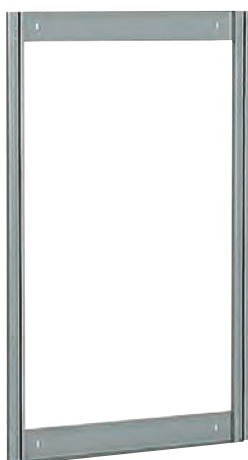
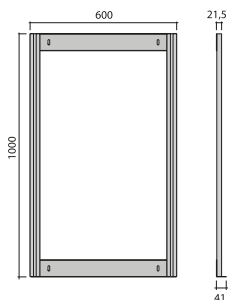

## DATASHEET

### A

Rear panel	1 x PR F100 0001
------------	------------------

### B

Rear panel	1 x PR F100 0001
Drawers set	6 x PR 9077 0001
	5 x PR 6112 0001

### B

Rear panel	1 x PR F100 0001
Drawers set	9 x PR 6112 0001

### D

Rear panel	1 x PR F100 0001
Drawers set	2 x PR 6112 0001
	2 x PR 5164 0001
	1 x PR 4206 0001
	1 x PR 3240 0001

### E

Optional base for shelf	1 x PR DBAS 0001
-------------------------	------------------

iMilani srl reserves the right to alter the characteristics of products without notice. The values shown are nominal, with a +/- 1% tolerance for size, depending on the material, and a +/- 3% for weight.

# Module width 600 mm

ARTICLE	WIDTH	DEPTH	HEIGHT	NUMBER OF TILTING DRAWERS	PACKAGING		UNIT PRICE €
					Qty. per pack.	Qty. per pallet	
A PR F150 0001	600	41	1500	-	1	-	
B PR F150123 0201	600	113	1500	123	1	-	
C PR F150084 0101	600	113	1568	84	1	-	
D PR F150064 0501	600	224	1540	64	1	-	
E PR DBAS 0001	600	300	100	-	1	-	



**B**



**A**

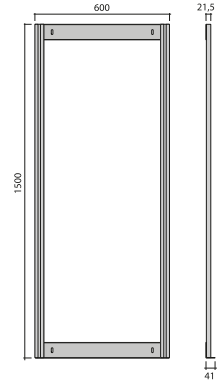
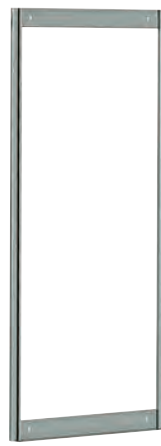

**C**



**D**



**E**



A	
Rear panel	1 x PR F150 0001
B	
Rear panel	1 x PR F150 0001
Drawers set	9 x PR 9077 0001
	7 x PR 6112 0001
C	
Rear panel	1 x PR F150 0001
Drawers set	14 x PR 6112 0001
D	
Rear panel	1 x PR F150 0001
Drawers set	2 x PR 9077 0001
	4 x PR 6112 0001
	3 x PR 5164 0001
	1 x PR 4206 0001
	1 x PR 3240 0001
E	
Optional base for shelf	1 x PR DBAS 0001

DATASHEET

iMilani srl reserves the right to alter the characteristics of products without notice. The values shown are nominal, with a +/- 1% tolerance for size, depending on the material, and a +/- 3% for weight.



# Module width 600 mm

iMICUBE

ARTICLE	WIDTH	DEPTH	HEIGHT	NUMBER OF TILTING DRAWERS	PACKAGING		UNIT PRICE €
					Qty. per pack.	Qty. per pallet	
<b>A</b> PR F175 0001	600	41	1750	-	1	-	
<b>B</b> PR F175132 0201	600	113	1750	132	1	-	
<b>C</b> PR F175099 0201	600	113	1750	99	1	-	
<b>D</b> PR F175066 0501	600	224	1750	66	1	-	
<b>E</b> PR DBAS 0001	600	300	100		1		

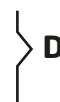
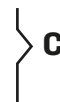
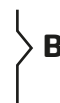
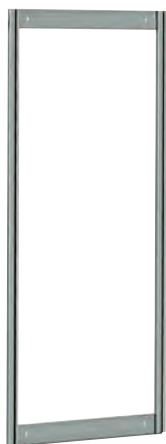
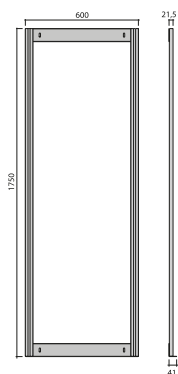

## DATASHEET

### A

Rear panel	1 x PR F175 0001
------------	------------------

### B

Rear panel	1 x PR F175 0001
Drawers set	8 x PR 9077 0001
	10 x PR 6112 0001

### C

Rear panel	1 x PR F175 0001
Drawers set	1 x PR 9077 0001
	15 x PR 6112 0001

### D

Rear panel	1 x PR F175 0001
Drawers set	1 x PR 9077 0001
	6 x PR 6112 0001
	2 x PR 5164 0001
	2 x PR 4206 0001
	1 x PR 3240 0001

### E

Optional base for shelf	1 x PR DBAS 0001
-------------------------	------------------

iMilani srl reserves the right to alter the characteristics of products without notice. The values shown are nominal, with a +/- 1% tolerance for size, depending on the material, and a +/- 3% for weight.

# Module width 600 mm

ARTICLE	WIDTH	DEPTH	HEIGHT	NUMBER OF TILTING DRAWERS	PACKAGING		UNIT PRICE €
					Qty. per pack.	Qty. per pallet	
A PR F195 0001	600	41	1950	-	1	-	
B PR F195144 0201	600	113	1960	144	1	-	
C PR F195100 0301	600	156	1950	100	1	-	
D PR F195043 0401	600	326	1989	43	1	-	
E PR DBAS 0001	600	300	100	-	1	-	



**B**



**A**

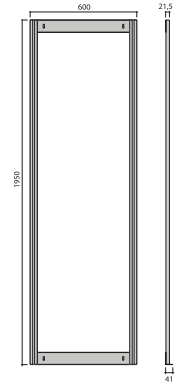

**C**



**D**



**E**



A	
Rear panel	1 x PR F195 0001
B	
Rear panel	1 x PR F195 0001
Drawers set	8 x PR 9077 0001
	12 x PR 6112 0001
C	
Rear panel	1 x PR F195 0001
Drawers set	3 x PR 9077 0001
	8 x PR 6112 0001
	5 x PR 5164 0001
D	
Rear panel	1 x PR F195 0001
Drawers set	6 x PR 5164 0001
	2 x PR 4206 0001
	1 x PR 3240 0001
	1 x PR 2353 0001
E	
Optional base for shelf	1 x PR DBAS 0001

DATASHEET

iMilani srl reserves the right to alter the characteristics of products without notice. The values shown are nominal, with a +/- 1% tolerance for size, depending on the material, and a +/- 3% for weight.

# Module width 600 mm

iMICUBE

Module depth 325 mm

ARTICLE	WIDTH	DEPTH	HEIGHT	NUMBER OF TILTING DRAWERS	PACKAGING		UNIT PRICE €
					Qty. per pack.	Qty. per pallet	
<b>A</b> PR D150 0001	600	325	1500	-	1	-	
<b>B</b> PR D150 114 0201	600	325	1500	114	1	-	
<b>C</b> PR D150 078 0101	600	325	1556	78	1	-	
<b>D</b> PR D150 058 0501	600	325	1528	58	1	-	

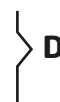
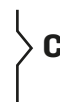
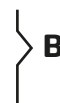
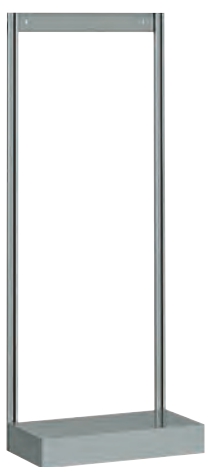
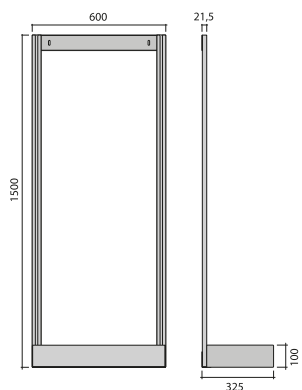

## DATASHEET

### A

Rear panel with base	1 x PR D150 0001
----------------------	------------------

### B

Rear panel with base	1 x PR D150 0001
Drawers set	8 x PR 9077 0001
	7 x PR 6112 0001

### C

Rear panel with base	1 x PR D150 0001
Drawers set	13 x PR 6112 0001

### D

Rear panel with base	1 x PR D150 0001
Drawers set	2 x PR 9077 0001
	3 x PR 6112 0001
	3 x PR 5164 0001
	1 x PR 4206 0001
	1 x PR 3240 0001

iMilani srl reserves the right to alter the characteristics of products without notice. The values shown are nominal, with a +/- 1% tolerance for size, depending on the material, and a +/- 3% for weight.

# Module width 600 mm

Module depth 325 mm

ARTICLE	WIDTH	DEPTH	HEIGHT	NUMBER OF TILTING DRAWERS	PACKAGING		UNIT PRICE €
					Qty. per pack.	Qty. per pallet	
<b>A</b> PR D175 0001	600	325	1750	-	1	-	
<b>B</b> PR D175 112 0301	600	325	1786	112	1	-	
<b>C</b> PR D175 062 0501	600	325	1750	62	1	-	
<b>D</b> PR D175 057 0301	600	325	1770	57	1	-	



**B**



**A**

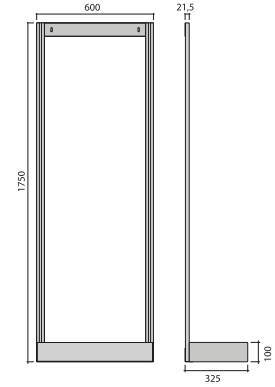
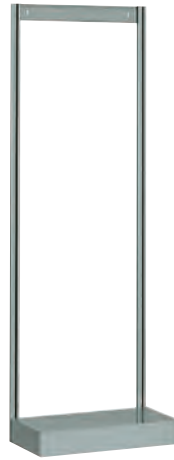

**C**



**D**



A	
Rear panel with base	1 x PR F175 0001
B	
Rear panel with base	1 x PR D175 0001
Drawers set	6 x PR 9077 0001
	8 x PR 6112 0001
	2 x PR 5164 0001
C	
Rear panel with base	1 x PR D175 0001
Drawers set	2 x PR 9077 0001
	3 x PR 6112 0001
	3 x PR 5164 0001
	2 x PR 4206 0001
	1 x PR 3240 0001
D	
Rear panel with base	1 x PR D175 0001
Drawers set	5 x PR 6112 0001
	3 x PR 5164 0001
	3 x PR 4206 0001

DATASHEET

iMilani srl reserves the right to alter the characteristics of products without notice. The values shown are nominal, with a +/- 1% tolerance for size, depending on the material, and a +/- 3% for weight.

# Module width 600 mm

iMICUBE

Module depth 325 mm

ARTICLE	WIDTH	DEPTH	HEIGHT	NUMBER OF TILTING DRAWERS	PACKAGING		UNIT PRICE €
					Qty. per pack.	Qty. per pallet	
<b>A</b> PR D195 0001	600	325	1950	-	1	-	
<b>B</b> PR D195 117 0401	600	325	1950	117	1	-	
<b>C</b> PR D195 066 0501	600	325	1950	66	1	-	
<b>D</b> PR D195 061 0301	600	325	1976	61	1	-	

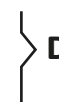
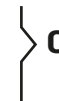
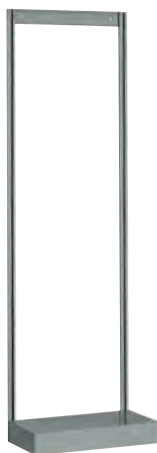
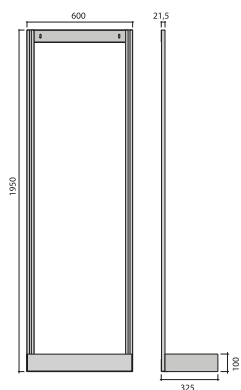

## DATASHEET

A	
Rear panel with base	1 x PR D195 0001
B	
Rear panel with base	1 x PR D195 0001
Drawers set	6 x PR 9077 0001
	9 x PR 6112 0001
	1 x PR 5164 0001
	1 x PR 4206 0001
C	
Rear panel with base	1 x PR D195 0001
Drawers set	2 x PR 9077 0001
	3 x PR 6112 0001
	3 x PR 5164 0001
	3 x PR 4206 0001
	1 x PR 3240 0001
D	
Rear panel with base	1 x PR D195 0001
Drawers set	5 x PR 6112 0001
	3 x PR 5164 0001
	4 x PR 4206 0001

iMilani srl reserves the right to alter the characteristics of products without notice. The values shown are nominal, with a +/- 1% tolerance for size, depending on the material, and a +/- 3% for weight.

# Swivel structure

ARTICLE	WIDTH	DEPTH	HEIGHT	NUMBER OF TILTING DRAWERS	PACKAGING		UNIT PRICE €
					Qty. per pack.	Qty. per pallet	
<b>A</b> PR R186260 0401	900	900	1865	260	1	-	
<b>B</b> PR R161 0001	900	900	1615	-	1	-	
<b>C</b> PR R186 0001	900	900	1865	-	1	-	
<b>D</b> PR R206 0001	900	900	2065	-	1	-	



**A**

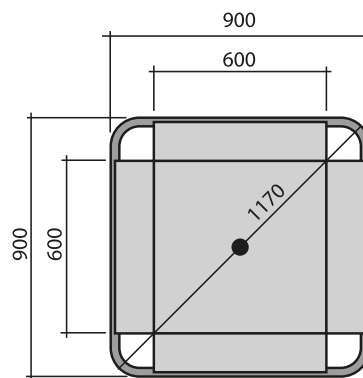

**B**  
**C**  
**D**

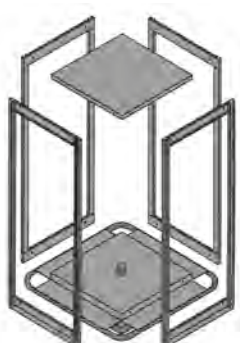

The Practibox swivel shelf consists of a 360° swivel base that houses 4 Practibox drawer unit holder frames, available in 3 different heights. Capacious, robust, practical – characteristics that make it usable in both large and small spaces.

The swivel base must be fixed to the floor

iMilani srl reserves the right to alter the characteristics of products without notice. The values shown are nominal, with a +/- 1% tolerance for size, depending on the material, and a +/- 3% for weight.

A	
Swivel structure with 4 frames	1 x PR R186 0001
Drawers set	2 x PR 9077 0001
	18 x PR 6112 0001
	22 x PR 5164 0001
	6 x PR 4206 0001
B	
Swivel structure with 4 frames	1 x PR R161 0001
C	
Swivel structure with 4 frames	1 x PR R186 0001
D	
Swivel structure with 4 frames	1 x PR R206 0001

DATASHEET



14.021

14.022

14.023

14.024

14.025

14.026

14.027

14.028

14.029

14.027 24

14.028

14.030

14.031

14.032

14.033

14.025

14.027 24

14.028

14.030

14.031

14.032

14.033

14.034

14.032

14.033

14.033

14.034

14.035

14.036

14.037

14.032

14.033

14.033

14.034

14.035

14.036

14.037

14.032 14

14.033

14.034

14.035

14.036

14.037

14.039 36

14.040

14.041 32

14.042

14.043

14.039

14.039 36

14.040

14.041

14.042

14.043

14.041

14.042

14.043 32

14.044 44

14.045

14.044 40

14.045

14.046





# Cabinets with removable frames

iMICUBE

## Extractable frame holder 400 kg

ARTICLE	WIDTH	DEPTH	HEIGHT	NUMBER OF TILTING DRAWERS	PACKAGING		UNIT PRICE €
					Qty. per pack.	Qty. per pallet	
<b>A</b> PR COOL 5001	1073	705	2000	-	1	-	
<b>B</b> PR COOL 7001	1481	705	2000	-	1	-	
<b>C</b> PR C000 0401	-	705	1900	1765	1	-	
<b>D</b> PR FX 0099	-	-	-	-	2	-	

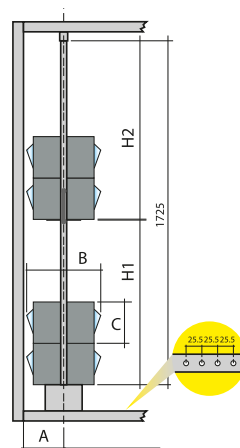

A  
B

### DATASHEET

#### A

Cabinet for extractable frames with lock	PR COOL 5001
Usable cabinet width mm	967

#### B

Cabinet for extractable frames with lock	PR COOL 7001
Usable cabinet width mm	1375

#### C

Removable frame capacity 400 kg	PR C000 0401
---------------------------------	--------------

#### D

Pair of anchor bolts for fixing a side unit	PR FIX 0099
---	-------------

Drawer unit	A	B*	C	Q.ty H1	Q.ty H2
PR 2353 ...	330,5	650	352	2	2
PR 3240 ...	228,5	445	241	3	3
PR 4206 ...	203,5	380	207	4	4
PR 5164 ...	177,5	315	164	5	5
PR 6112 ...	126,5	225	112	7	8
PR 9077 ...	101,5	170	77	10	11

B\* - see usable width of cabinets without removable frames

\* see useful width of cabinets without drawers



C



D

⚠ The cabinet comes assembled  
The cabinet must be fixed to the floor

iMilani srl reserves the right to alter the characteristics of products without notice. The values shown are nominal, with a +/- 1% tolerance for size, depending on the material, and a +/- 3% for weight.

# Compositions with and without drawers

Extractable frame 400 kg



ARTICLE	WIDTH	DEPTH	HEIGHT	NUMBER OF TILTING DRAWERS	PACKAGING		UNIT PRICE €
					Qty. per pack.	Qty. per pallet	
A PR C41L 5401	1073	705	2000	-	1	-	
B PR C41L720 5401	1073	705	2000	720	1	-	
C PR C32L 5401	1073	705	2000	-	1	-	
D PR C32L380 5401	1073	705	2000	380	1	-	
E PR C33L 5401	1073	705	2000	-	1	-	
F PR C33L344 5401	1073	705	2000	344	1	-	

A  
B

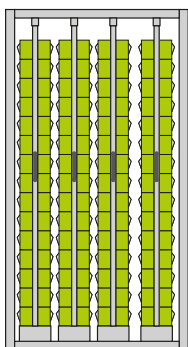

C  
D

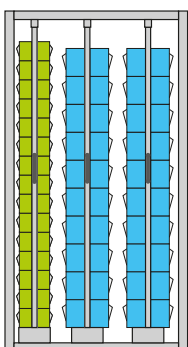

E  
F

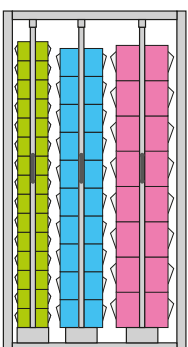

⚠ The cabinet must be fixed to the floor

iMilani srl reserves the right to alter the characteristics of products without notice. The values shown are nominal, with a +/- 1% tolerance for size, depending on the material, and a +/- 3% for weight.

<b>A</b>	
Cabinet with 4 extractable frames with lock	1x PRC41L 5401
<b>B</b>	
Cabinet with 4 extractable frames with lock	1x PRC41L 5401
Drawers set	120 x PR 6112 0001
<b>C</b>	
Cabinet with 3 extractable frames with lock	1x PRC32L 5401
<b>D</b>	
Cabinet with 3 extractable frames with lock	1x PRC32L 5401
Drawers set	30 x PR 6112 0001
	40 x PR 5164 0001
<b>E</b>	
Cabinet with 3 extractable frames with lock	1x PRC33L 5401
<b>F</b>	
Cabinet with 3 extractable frames with lock	1x PRC33L 5401
Drawers set	30 x PR 6112 0001
	20 x PR 5164 0001
	16 x PR 4206 0001

DATASHEET

# Compositions with and without drawers

## Extractable frame 400 kg

ARTICLE	WIDTH	DEPTH	HEIGHT	NUMBER OF TILTING DRAWERS	PACKAGING		UNIT PRICE €
					Qty. per pack.	Qty. per pallet	
<b>A</b> PR C51L 7401	1481	705	2000	-	1	-	
<b>B</b> PR C51L900 7401	1481	705	2000	900	1	-	
<b>C</b> PR C42L 7401	1481	705	2000	-	1	-	
<b>D</b> PR C42L480 7401	1481	705	2000	480	1	-	
<b>E</b> PR C31L 7401	1481	705	2000	-	1	-	
<b>F</b> PR C31L192 7401	1481	705	2000	192	1	-	

### DATASHEET

<b>A</b>	
Cabinet with 5 extractable frames with lock	1x PR C51L 7401
<b>B</b>	
Cabinet with 5 extractable frames with lock	1x PR C51L 7401
Drawers set	150 x PR 6112 0001
<b>C</b>	
Cabinet with 4 extractable frames with lock	1x PR C42L 7401
<b>D</b>	
Cabinet with 4 extractable frames with lock	1x PR C42L 7401
Drawers set	30 x PR 6112 0001
	60 x PR 5164 0001
<b>E</b>	
Cabinet with 3 extractable frames with lock	1x PR C31L 7401
<b>F</b>	
Cabinet with 3 extractable frames with lock	1x PR C31L 7401
Drawers set	48 x PR 4206 0001

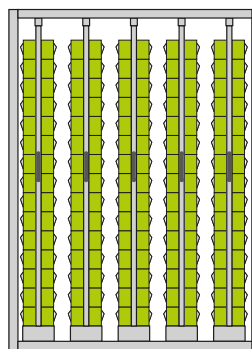

A  
B

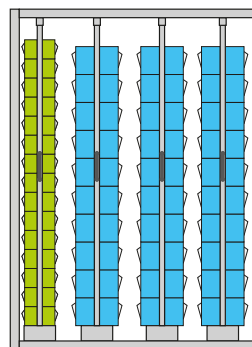

C  
D

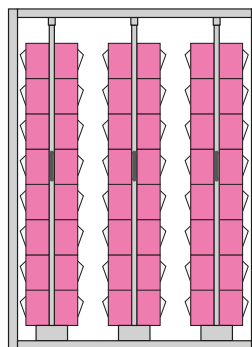

E  
F

The cabinet must be fixed to the floor

iMilani srl reserves the right to alter the characteristics of products without notice. The values shown are nominal, with a +/- 1% tolerance for size, depending on the material, and a +/- 3% for weight.



# RK

Everything in order and clearly visible for flexible and functional storage: this is the result of the design and construction of the **RK** series of polypropylene boxes and their dedicated shelving system.

Available in eleven different sizes to meet every need, the drawers are ideal for spare parts dealers on account of their resistance to oils and their internal divisibility.

## WALLS



Made of top quality polypropylene, the RK boxes have walls strengthened with special ribbing to protect against shocks.

## LABELS

## HANDLES



Fitted with label holders available in various sizes proportionate to the size of the boxes to which they are applied.

A special handle can be supplied on request for easy lifting and transportation of the RK boxes.

## BOTTOMS

## DIVIDERS

smooth bottom



Made of transparent polystyrene, the dividers allow the inside of the boxes to be partitioned into several compartments.

	ARTICLE	BOTTOM WALLS HANDLES	TRANSVERSE DIVIDERS APPLICABLE	LONGITUDINAL DIVIDERS APPLICABLE	GR.	PACKAGING		UNIT PRICE €
		Closed				Qty. per pack.	Qty. per pallet	
	RK 3012 5104	■	4	1	340	32	512	
	<b>A</b> RK 3012 5207	■	4	1	380	32	512	
	RK 3012 5401	■	4	1	374	32	512	
	RK 3016 5104	■	4	1	370	24	384	
	<b>B</b> RK 3016 5207	■	4	1	414	24	384	
	RK 3016 5401	■	4	1	387	24	384	

A



B



**A**

Usable internal dimensions	257 x 95 x 97 H mm
Pieces per pack / pallet	32  512
Package dimensions	970 x 310 x 385 H mm
Pallet dimensions	1300 x 1000 x 1700 H mm

**B**

Usable internal dimensions	257 x 136 x 97 H mm
Pieces per pack / pallet	24  384
Package dimensions	970 x 310 x 390 H mm
Pallet dimensions	1300 x 1000 x 1700 H mm

DATASHEET

# Depth 300 mm

iMICUBE

Width 120 - 160 mm

ARTICLE	DESCRIPTION	GR.	PACKAGING		UNIT PRICE €
			Qty. per pack.	Qty. per pallet	
<b>D</b> RK H120 5104	Handle facilitated grip for width 120 mm	16	1		
RK H120 5401		18	1		
RK H120 5207		19	1		
<b>D</b> RK H160 5104	Handle facilitated grip for width 160 mm	18	1		
RK H160 5207		20	1		
RK H160 5401		19	1		
<b>E</b> RK D120 5207	Divider for width 120 mm	25	1		
RK D120 6896		22	1		
<b>E</b> RK D160 5207		Divider for width 160 mm	32	1	
RK D160 6896	28		1		
<b>F</b> RK D300 0099	Galvanised longitudinal divider	200	1		
<b>G</b> LB 08024 2401	Divider label 120 mm		1		
LB 12124 1601	Divider label 160 mm		1		
<b>H</b> LB 08142 1201	Front Label for W=120 mm		1		
LB 12144 0801	Front Label for W=160 mm		1		



## DATASHEET

### D

Handle for RK3012	70 x 90 H mm
Handle for RK3016	110 x 90 H mm

### E

Divider size RK3012	100 x 90 H mm
Divider size RK3016	145 x 90 H mm

### F

Galvanised longitudinal divider	268 x 88 H mm
---------------------------------	---------------

### G

Sheet of 24 labels for RK D120	80 x 24 mm
Sheet of 16 labels for RK D160	121 x 24 mm

### H

Sheet of 12 labels for RK3012	81 x 42 mm
Sheet of 8 labels for RK3016	121 x 44 mm

iMilani srl reserves the right to alter the characteristics of products without notice. The values shown are nominal, with a +/- 1% tolerance for size, depending on the material, and a +/- 3% for weight.

	ARTICLE	BOTTOM WALLS HANDLES	TRANSVERSE DIVIDERS APPLICABLE	LONGITUDINAL DIVIDERS APPLICABLE	GR.	PACKAGING		UNIT PRICE €
		Closed				Qty. per pack.	Qty. per pallet	
  ECOGREEN	<b>A</b> RK 4012 5104	■	6	1	438	32	384	
	RK 4012 5207	■	6	1	491	32	384	
	RK 4012 5401	■	6	1	458	32	384	
  ECOGREEN	<b>B</b> RK 4016 5104	■	6	1	448	24	288	
	RK 4016 5207	■	6	1	502	24	288	
	RK 4016 5401	■	6	1	468	24	288	
  ECOGREEN	<b>C</b> RK 4024 5104	■	6	3	644	16	192	
	RK 4024 5207	■	6	3	721	16	192	
	RK 4024 5401	■	6	3	673	16	192	



**A**

Usable internal dimensions	357 x 95 x 97 H mm
Pieces per pack / pallet	32  384
Package dimensions	970 x 415 x 400 H mm
Pallet dimensions	1300 x 1000 x 1700 H mm

**B**

Usable internal dimensions	357 x 136 x 97 H mm
Pieces per pack / pallet	24  288
Package dimensions	970 x 415 x 400 H mm
Pallet dimensions	1300 x 1000 x 1700 H mm

**C**

Usable internal dimensions	357 x 215 x 97 H mm
Pieces per pack / pallet	16  192
Package dimensions	970 x 415 x 400 H mm
Pallet dimensions	1300 x 1000 x 1700 H mm

iMilani srl reserves the right to alter the characteristics of products without notice. The values shown are nominal, with a +/- 1% tolerance for size, depending on the material, and a +/- 3% for weight.



# Depth 400 mm

iMICUBE

Width 120 - 160 - 240 mm

ARTICLE	DESCRIPTION	GR.	PACKAGING		UNIT PRICE €
			Qty. per pack.	Qty. per pallet	
RK H120 5104	Handle facilitated grip for width 120 mm	16	1		
RK H120 5207		19	1		
RK H120 5401		18	1		
RK H160 5104	Handle facilitated grip for width 160 mm	18	1		
RK H160 5207		20	1		
RK H160 5401		19	1		
RK H240 5104	Handle facilitated grip for width 240 mm	20	1		
RK H240 5207		23	1		
RK H240 5401		22	1		
RK D120 5207	Divider for width 120 mm	25	1		
RK D120 6896		22	1		
RK D160 5207	Divider for width 160 mm	32	1		
RK D160 6896		28	1		
RK D240 5207	Divider for width 240 mm	56	1		
RK D240 6896		50	1		
F RK D400 0099	Galvanised longitudinal divider	280	1		
LB 08024 2401	Divider label 120 mm		1		
LB 12124 1601	Divider label 160 - 240 mm		1		
LB 08142 1201	Front Label for W=120 mm		1		
H LB 12144 0801	Front Label for W=160 mm		1		
LB 20043 0601	Front Label for W=240 mm		1		



## DATASHEET

### D

Handle for RK4012	70 x 90 H mm
Handle for RK4016	110 x 90 H mm
Handle for RK4024	120 x 80 H mm

### E

Divider size RK4012	100 x 90 H mm
Divider size RK4016	145 x 90 H mm
Divider size RK4024	225 x 90 H mm

### F

Galvanised longitudinal divider	368 x 88 H mm
---------------------------------	---------------

### G

Sheet of 24 labels for RK D120	80 x 24 mm
Sheet of 16 labels for RK D160/RK D240	121 x 24 mm

### H

Sheet of 12 labels for RK4012	81 x 42 mm
Sheet of 8 labels for RK4016	121 x 44 mm
Sheet of 6 labels for RK4024	200 x 43 mm

iMilani srl reserves the right to alter the characteristics of products without notice. The values shown are nominal, with a +/- 1% tolerance for size, depending on the material, and a +/- 3% for weight.

# Depth 500 mm

Width 120 - 160 - 240 mm H 100

	ARTICLE	BOTTOM WALLS HANDLES	TRANSVERSE DIVIDERS APPLICABLE	LONGITUDINAL DIVIDERS APPLICABLE	GR.	PACKAGING		UNIT PRICE €
						Qty. per pack.	Qty. per pallet	
		Closed						
	RK 5012 5104	■	8	1	528	32	256	
<b>A</b>	RK 5012 5207	■	8	1	591	32	256	
	RK 5012 5401	■	8	1	552	32	256	
	RK 5016 5104	■	8	1	540	24	192	
<b>B</b>	RK 5016 5207	■	8	1	605	24	192	
	RK 5016 5401	■	8	1	564	24	192	
	RK 5024 5104	■	8	3	766	16	128	
<b>C</b>	RK 5024 5207	■	8	3	858	16	128	
	RK 5024 5401	■	8	3	800	16	128	



**A**

Usable internal dimensions	457 x 95 x 97 H mm
Pieces per pack / pallet	32  256
Package dimensions	970 x 515 x 390 H mm
Pallet dimensions	1050 x 1000 x 1700 H mm

**B**

Usable internal dimensions	457 x 136 x 97 H mm
Pieces per pack / pallet	24  192
Package dimensions	970 x 515 x 390 H mm
Pallet dimensions	1050 x 1000 x 1700 H mm

**C**

Usable internal dimensions	457 x 215 x 97 H mm
Pieces per pack / pallet	16  128
Package dimensions	970 x 515 x 390 H mm
Pallet dimensions	1050 x 1000 x 1700 H mm

DATASHEET

iMilani srl reserves the right to alter the characteristics of products without notice. The values shown are nominal, with a +/- 1% tolerance for size, depending on the material, and a +/- 3% for weight.

# Depth 500 mm

iMICUBE

Width 120 - 160 - 240 mm

ARTICLE	DESCRIPTION	GR.	PACKAGING		UNIT PRICE €
			Qty. per pack.	Qty. per pallet	
RK H120 5104	Handle facilitated grip for width 120 mm	16	1		
RK H120 5207		18	1		
RK H120 5401		19	1		
RK H160 5104	Handle facilitated grip for width 160 mm	16	1		
RK H160 5207		18	1		
RK H160 5401		19	1		
RK H240 5104	Handle facilitated grip for width 240 mm	20	1		
RK H240 5207		22	1		
RK H240 5401		23	1		
RK D120 5207	Divider for width 120 mm	25	1		
RK D120 6896		22	1		
RK D160 5207	Divider for width 160 mm	32	1		
RK D160 6896		28	1		
RK D240 5207	Divider for width 240 mm	56	1		
RK D240 6896		50	1		
F RK D500 0099	Galvanised longitudinal divider	360	1		
LB 08024 2401	Divider label 120 mm		1		
LB 12124 1601	Divider label 160 - 240 mm		1		
LB 08142 1201	Front Label for W=120 mm		1		
H LB 12144 0801	Front Label for W=160 mm		1		
LB 20043 0601	Front Label for W=240 mm		1		



## DATASHEET

### D

Handle for RK5012	70 x 90 H mm
Handle for RK5016	110 x 90 H mm
Handle for RK5024	120 x 80 H mm

### E

Divider size RK5012	100 x 90 H mm
Divider size RK5016	145 x 90 H mm
Divider size RK5024	225 x 90 H mm

### F

Galvanised longitudinal divider	468 x 88 H mm
---------------------------------	---------------

### G

Sheet of 24 labels for RK D120	80 x 24 mm
Sheet of 16 labels for RK D160/RK D240	121 x 24 mm



### H

Sheet of 12 labels for RK5012	81 x 42 mm
Sheet of 8 labels for RK5016	121 x 44 mm
Sheet of 6 labels for RK5024	200 x 43 mm

iMilani srl reserves the right to alter the characteristics of products without notice. The values shown are nominal, with a +/- 1% tolerance for size, depending on the material, and a +/- 3% for weight.

## Depth 600 mm

Width 160 mm H 100

ARTICLE	BOTTOM WALLS HANDLES	TRANSVERSE DIVIDERS APPLICABLE	LONGITUDINAL DIVIDERS APPLICABLE	GR.	PACKAGING		UNIT PRICE €
	Closed				Qty. per pack.	Qty. per pallet	
 RK 6016 5104	■	10	1	662	24	192	
 <b>A</b> RK 6016 5207	■	10	1	741	24	192	
 RK 6016 5401	■	10	1	692	24	192	

## Depth 655 mm

Width 160 mm H 100

ARTICLE	BOTTOM WALLS HANDLES	TRANSVERSE DIVIDERS APPLICABLE	LONGITUDINAL DIVIDERS APPLICABLE	GR.	PACKAGING		UNIT PRICE €
	Closed				Qty. per pack.	Qty. per pallet	
 <b>B</b> RK 6516 5207	■	11	1	816	24	192	

## Depth 434 mm

Width 140 mm H 80

ARTICLE	BOTTOM WALLS HANDLES	TRANSVERSE DIVIDERS APPLICABLE	LONGITUDINAL DIVIDERS APPLICABLE	GR.	PACKAGING		UNIT PRICE €
	Closed				Qty. per pack.	Qty. per pallet	
 <b>C</b> RK 4314 5104	■	7	-	324	30	540	

A





B





C





A

Usable internal dimensions	560 x 136 x 97 H mm
Pieces per pack / pallet	 24  192
Package dimensions	970 x 620 x 390 H mm
Pallet dimensions	1300 x 1000 x 1700 H mm

B

Usable internal dimensions	613 x 136 x 97 H mm
Pieces per pack / pallet	 24  192
Package dimensions	980 x 670 x 390 H mm
Pallet dimensions	1300 x 1000 x 1700 H mm

C





Usable internal dimensions	403 x 121 x 76 H mm
Pieces per pack / pallet	 30  540
Package dimensions	450 x 410 x 460 H mm
Pallet dimensions	1300 x 1000 x 1530 H mm

DATASHEET

# Depth 600 mm

iMICUBE

Width 160 mm

ARTICLE	DESCRIPTION	GR.	PACKAGING		UNIT PRICE €	
			Qty. per pack.	Qty. per pallet		
<b>RK H160 5104</b>	Handle facilitated grip for width 160 mm	16	1			  
<b>D RK H160 5207</b>		18	1			
<b>RK H160 5401</b>		19	1			
<b>RK D140 6896</b>	Divider for width 140 mm	22	1			
<b>E RK D160 5207</b>	Divider for width 160 mm	32	1			
<b>RK D160 6896</b>		28	1			
<b>F RK D600 0099</b>	Galvanised longitudinal divider	420	1			
<b>LB 8024 2401</b>	Divider label 140 mm		1			
<b>G LB 12124 1601</b>	Divider label 160 mm		1			
<b>H LB 12144 0801</b>	Front Label for W=140/160mm		1			



## DATASHEET

### D

Handle for RK6016	120 x 90 H mm
-------------------	---------------

### E

Divider size RK 4314	137 x 75 H mm
Divider size RK 6016	145 x 90 H mm

### F

Galvanised transverse divider size RK6016	568 x 88 H mm
---	---------------

### G

Sheet of 24 labels for RKD140	80 x 24 mm
Sheet of 16 labels for RK D160	121 x 24 mm

### H

Sheet of 8 labels for RK 4314-6016-6516	121 x 44 mm
---	-------------

iMilani srl reserves the right to alter the characteristics of products without notice. The values shown are nominal, with a +/- 1% tolerance for size, depending on the material, and a +/- 3% for weight.

A



B



C



D



ARTICLE	RK 3012	RK 3016	GR.	PACKAGING		UNIT PRICE €
				Qty. per pack.	Qty. per pallet	
A RK BX30 0001				1		
B RK BX31 5104	16			1		
C RK BX32 5104		12		1		
D RK BX33 5104	8	6		1		



Compositions complete with guides and rear stops

A

Box	1 x RK BX30 0001
-----	------------------

B

Box	1 x RK BX30 0001
Drawers set	16 x RK 3012 5104

C

Box	1 x RK BX30 0001
Drawers set	12 x RK 3016 5104

D

Box	1 x RK BX30 0001
Drawers set	8 x RK 3012 5104
	6 x RK 3016 5104

# Depth 300 mm

iMICUBE

ARTICLE	DESCRIPTION	GR.	PACKAGING		UNIT PRICE €
			Qty. per pack.	Qty. per pallet	
<b>I</b> RK F300 0001	Plinth for RK-BOX depth 300		1		
<b>L</b> RK RL30 0099	Guide for RK-BOX depth 300		1		
<b>M</b> RK S500 0099	Galvanised front stop		1		
<b>N</b> RK S120 1099	Galvanised rear front 120 mm		1		
	Galvanised rear front 160 mm		1		

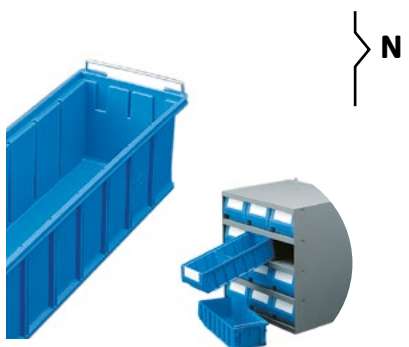
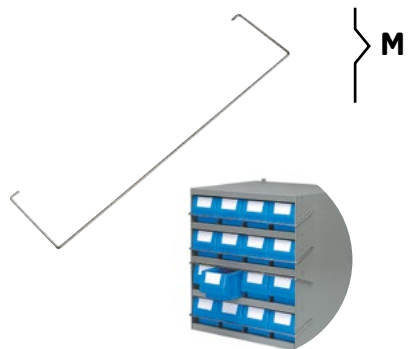
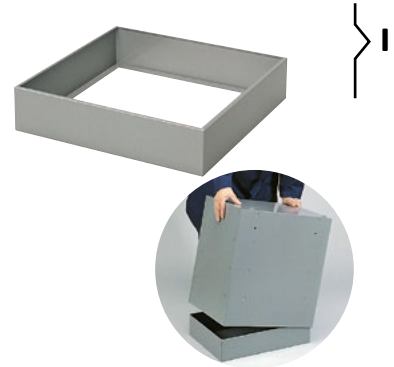

DATASHEET

<b>I</b>	
Plinth for BX30	485 x 275 x 90 H mm
<b>L</b>	
Galvanised guides for BX30	300 mm
<b>M</b>	
Galvanised stop for RK-BOX	485 mm
<b>N</b>	
Galvanised rear stop	120 - 160 mm

iMilani srl reserves the right to alter the characteristics of products without notice. The values shown are nominal, with a +/- 1% tolerance for size, depending on the material, and a +/- 3% for weight.





# 500 x 545 H - Depth 400 mm

iMILCUBE

	ARTICLE	RK 4012	RK 4016	RK 4024	GR.	PACKAGING		UNIT PRICE €
						Qty. per pack.	Qty. per pallet	
<b>A</b>	RK BX40 0001					1		
<b>B</b>	RK BX41 5104	16				1		
<b>C</b>	RK BX42 5104		12			1		
<b>D</b>	RK BX43 5104	8	6			1		



Compositions complete with guides and rear stops



**A**



**B**



**C**



**D**

## DATASHEET

A	
Box	1 x RK BX40 0001
B	
Box	1 x RK BX40 0001
Drawers set	16 x RK 4012 5104
C	
Box	1 x RK BX40 0001
Drawers set	12 x RK 4016 5104
D	
Box	1 x RK BX40 0001
Drawers set	8 x RK 4012 5104
	6 x RK 4016 5104

iMilani srl reserves the right to alter the characteristics of products without notice. The values shown are nominal, with a +/- 1% tolerance for size, depending on the material, and a +/- 3% for weight.

# 500 x 545 H - Depth 400 mm

E



F



G



H



ARTICLE	RK 4012	RK 4016	RK 4024	GR.	PACKAGING		UNIT PRICE €
					Qty. per pack.	Qty. per pallet	
E RK BX44 5104			8		1		
F RK BX45 5104	8		4		1		
G RK BX46 5104		6	4		1		
H RK BX47 5104	4	6	2		1		

Compositions complete with guides and rear stops

E	
Box	1 x RK BX40 0001
Drawers set	8 x RK 4024 5104
F	
Box	1 x RK BX40 0001
Drawers set	8 x RK 4012 5104
	4 x RK 4024 5104
G	
Box	1 x RK BX40 0001
Drawers set	6 x RK 4016 5104
	4 x RK 4024 5104
H	
Box	1 x RK BX40 0001
Drawers set	4 x RK 4012 5104
	6 x RK 4016 5104
	2 x RK 4024 5104

DATASHEET

iMilani srl reserves the right to alter the characteristics of products without notice. The values shown are nominal, with a +/- 1% tolerance for size, depending on the material, and a +/- 3% for weight.

# Depth 400 mm

iMICUBE

ARTICLE	DESCRIPTION	GR.	PACKAGING		UNIT PRICE €
			Qty. per pack.	Qty. per pallet	
<b>I</b> RK F400 0001	Plinth for RK-BOX depth 400		1		
<b>L</b> RK RL40 0099	Guide for RK-BOX depth 400		1		
<b>M</b> RK S500 0099	Galvanised stop for RK-BOX		1		
<b>N</b>	RK S120 1099	Galvanised rear front 120 mm	1		
	RK S160 2099	Galvanised rear front 160/240 mm	1		

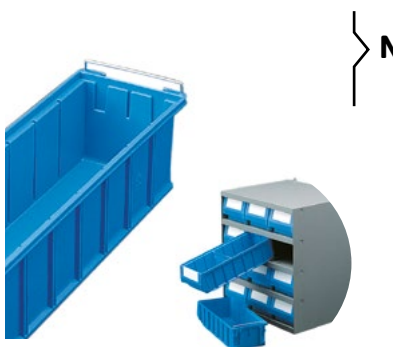
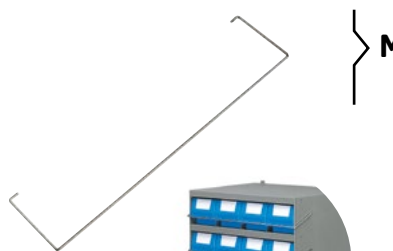

## DATASHEET

<b>I</b>	
Plinth for BX40	485 x 375 x 90 H mm
<b>L</b>	
Galvanised guides for BX40	400 mm
<b>M</b>	
Galvanised stop for RK-BOX	485 mm
<b>N</b>	
Galvanised rear stop	120 - 160 mm

iMilani srl reserves the right to alter the characteristics of products without notice. The values shown are nominal, with a +/- 1% tolerance for size, depending on the material, and a +/- 3% for weight.



# 500 x 545 H - Depth 500 mm

iMICUBE

	ARTICLE	RK 5012	RK 5016	RK 5024	GR.	PACKAGING		UNIT PRICE €
						Qty. per pack.	Qty. per pallet	
<b>A</b>	RK BX50 0001					1		
<b>B</b>	RK BX51 5104	16				1		
<b>C</b>	RK BX52 5104		12			1		
<b>D</b>	RK BX53 5104	8	6			1		



Compositions complete with guides and rear stops



## DATASHEET

A	
Box	1 x RK BX50 0001
B	
Box	1 x RK BX50 0001
Drawers set	16 x RK 5012 5104
C	
Box	1 x RK BX50 0001
Drawers set	12 x RK 5016 5104
D	
Box	1 x RK BX50 0001
Drawers set	8 x RK 5012 5104
	6 x RK 5016 5104

iMilani srl reserves the right to alter the characteristics of products without notice. The values shown are nominal, with a +/- 1% tolerance for size, depending on the material, and a +/- 3% for weight.

# 500 x 545 H - Depth 500 mm

E



F



G



H



	ARTICLE	RK 5012	RK 5016	RK 5024	GR.	PACKAGING		UNIT PRICE €
						Qty. per pack.	Qty. per pallet	
E	RK BX54 5104			8		1		
F	RK BX55 5104	8		4		1		
G	RK BX56 5104		6	4		1		
H	RK BX57 5104	4	6	2		1		

Compositions complete with guides and rear stops

E	
Box	1 x RK BX50 0001
Drawers set	8 x RK 5024 5104
F	
Box	1 x RK BX50 0001
Drawers set	8 x RK 5012 5104
	4 x RK 5024 5104
G	
Box	1 x RK BX50 0001
Drawers set	6 x RK 5016 5104
	4 x RK 5024 5104
H	
Box	1 x RK BX50 0001
Drawers set	4 x RK 5012 5104
	6 x RK 5016 5104
	2 x RK 5024 5104

DATASHEET

iMilani srl reserves the right to alter the characteristics of products without notice. The values shown are nominal, with a +/- 1% tolerance for size, depending on the material, and a +/- 3% for weight.

# Depth 500 mm

iMICUBE

ARTICLE	DESCRIPTION	GR.	PACKAGING		UNIT PRICE €
			Qty. per pack.	Qty. per pallet	
<b>I</b> RK F500 0001	Plinth for RK-BOX depth 500		1		
<b>L</b> RK RL50 0099	Guide for RK-BOX depth 500		1		
<b>M</b> RK S500 0099	Galvanised stop for RK-BOX		1		
<b>N</b>	RK S120 1099	Galvanised rear front 120 mm	1		
	RK S160 2099	Galvanised rear front 160/240 mm	1		

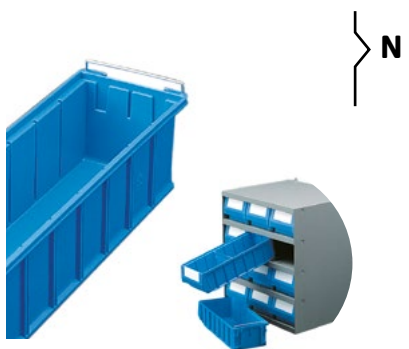
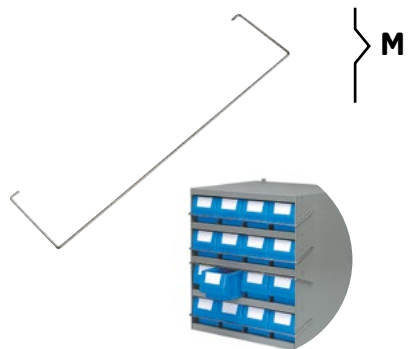
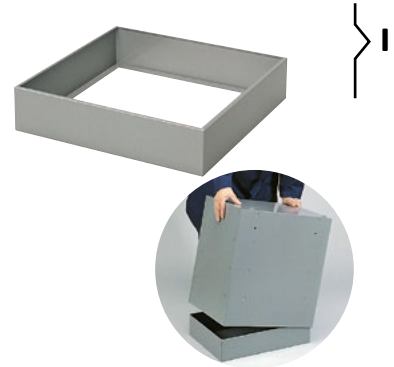

## DATASHEET

<b>I</b>	
Plinth for BX50	485 x 475 x 90 H mm
<b>L</b>	
Galvanised guides for BX50	500 mm
<b>M</b>	
Galvanised stop for RK-BOX	485 mm
<b>N</b>	
Galvanised rear stop	120 - 160 mm

iMilani srl reserves the right to alter the characteristics of products without notice. The values shown are nominal, with a +/- 1% tolerance for size, depending on the material, and a +/- 3% for weight.

# 500 x 545 H - Depth 600 mm

ARTICLE	RK 6016		GR.	PACKAGING		UNIT PRICE €
				Qty. per pack.	Qty. per pallet	
<b>A</b> RK BX60 0001				1		
<b>B</b> RK BX61 5104	12			1		

Compositions complete with guides and rear stops



A	
Box	1 x RK BX60 0001
B	
Box	1 x RK BX60 0001
Drawers set	12 x RK 6016 5104

DATASHEET



# Depth 600 mm

iMICUBE

ARTICLE	DESCRIPTION	GR.	PACKAGING		UNIT PRICE €
			Qty. per pack.	Qty. per pallet	
<b>I</b> RK F600 0001	Plinth for RK-BOX depth 600		1		
<b>L</b> RK RL60 0099	Guide for RK-BOX depth 600		1		
<b>M</b> RK S500 0099	Galvanised stop for RK-BOX		1		
<b>N</b>	RK S120 1099	Galvanised rear front 120 mm	1		
	RK S160 2099	Galvanised rear front 160 mm	1		

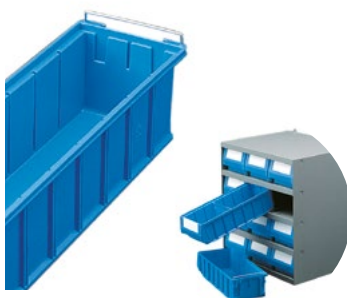
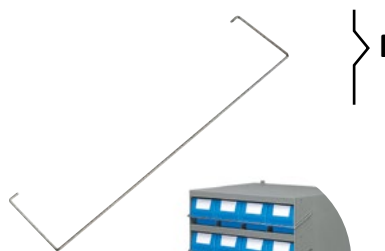

## DATASHEET

<b>I</b>	
Plinth for BX60	485 x 575 x 90 H mm
<b>L</b>	
Galvanised guides for BX60	600 mm
<b>M</b>	
Galvanised stop for RK-BOX	485 mm
<b>N</b>	
Galvanised rear stop	120 - 160 mm

iMilani srl reserves the right to alter the characteristics of products without notice. The values shown are nominal, with a +/- 1% tolerance for size, depending on the material, and a +/- 3% for weight.



# R-KLT

The **R-KLT** series, created within the VDA - German Association of the Automotive Industry project, is ideally applied in the automotive industry, facilitating the movement of goods between the components industries and car manufacturers.

Good resistance to oils, various automated handling options, tough ergonomic handles, a high level of safety and strength and a reinforced bottom to withstand heavy loads.

# BOTTOMS

300 x 200



400 x 300



600 x 400

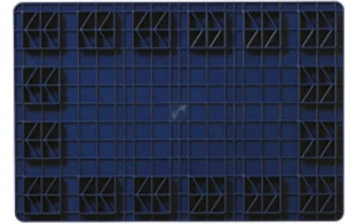

label holders  
on both sides



slot



600 mm

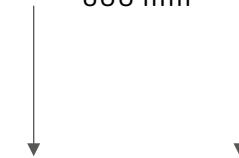

300 mm + 300 mm



hand grip



slot for vertical bracing

stackable upper edge

label holder

ergonomic handle

stackable lower edge

reinforced bottom

centring hole

stable gripping surface  
for extraction in autom. warehouses

guides for frontal handling



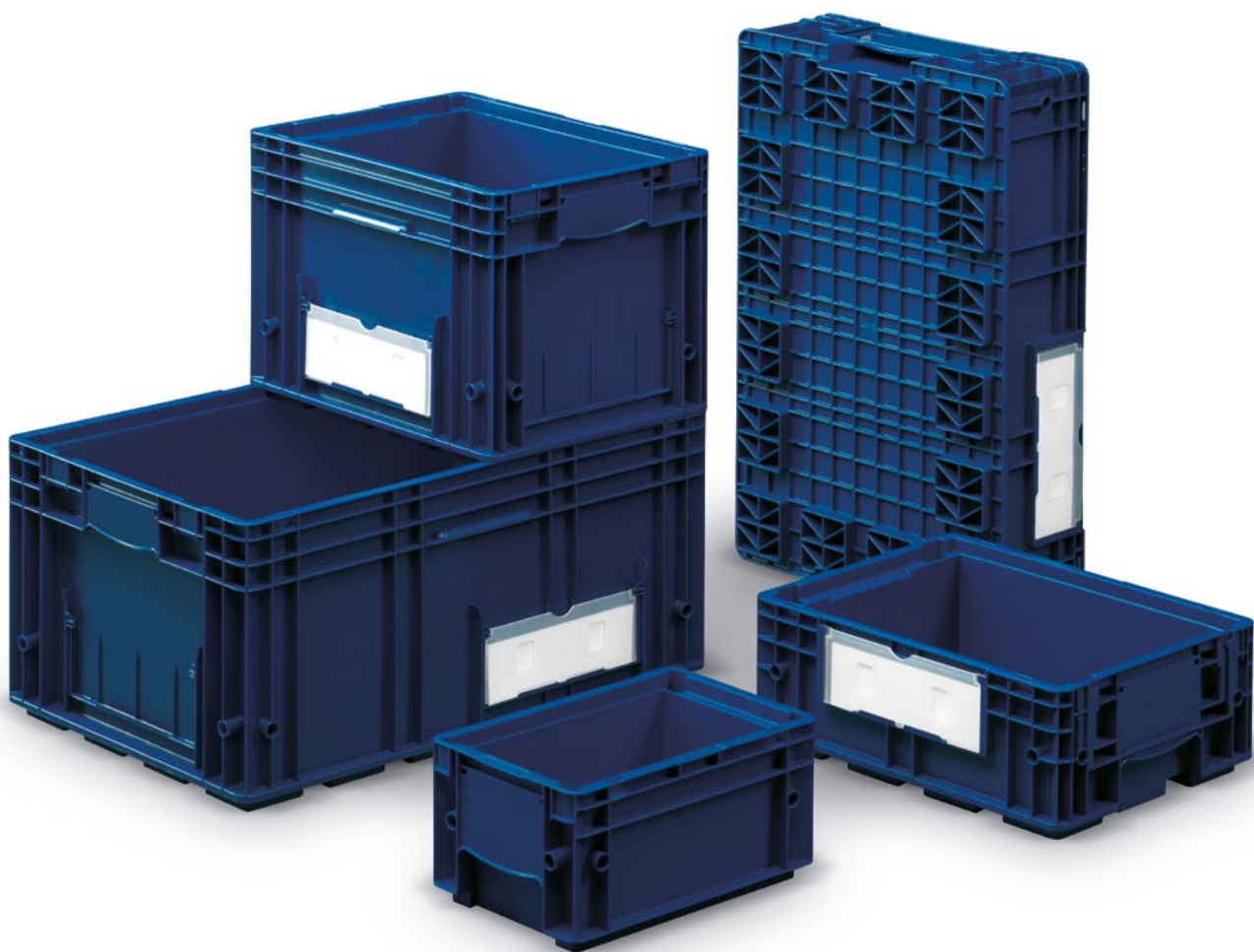

# 300 x 200 mm H 147 mm

iMICUBE

3215

R-KLT

181

KLT

	ARTICLE	WALLS		BOTTOM			HANDLES		GR.	PACKAGING		UNIT PRICE €
		Closed	Perforated	Closed	Perforated	Reinforced	Closed	Open		Qty. per pack.	Qty. per pallet	
A	KL 3215 511G	■			■		■		570	16	256	
B	KL LI35 511G								91	8	1280	
⚠ ARTICLE ON REQUEST												
A	KL 3215 5207	■			■		■		638	16	256	
B	KL LI35 5207								102	8	1280	
ACCESSORIES												
C	KL PROT 5100								25	8		

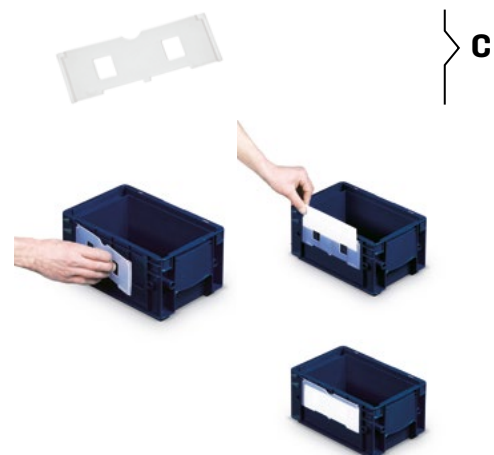
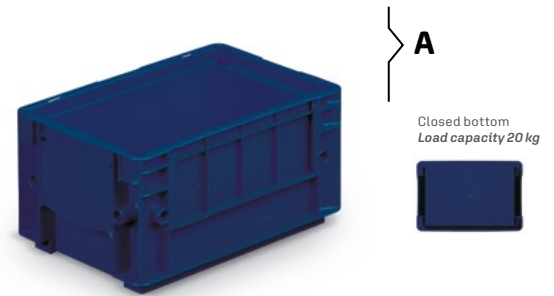

## DATASHEET

A	
Stacked edge height	132 mm
Usable stacked height / with lid	127 mm / 116 mm
Usable internal dimensions	243 x 161 x 142 H mm
Volume	5,3 L
Pieces per pack / pallet	16  256
Package dimensions	620 x 420 x 563 H mm
Pallet dimensions	1200 x 800 x 2277 H mm
B	
Lid	300 x 200 mm
Pieces per pack. / dimension	8 / 300 x 200 x 150 H mm
Pieces per pallet / dimension	1280 / 1200 x 800 x 1000 H mm
C	
Semi-opaque label protection	150 x 67 H mm
Pieces per pack	8

⚠ ARTICLES ON REQUEST  
 Minimum order.....200 boxes  
 Guaranteed shipping within.....60 days

iMilani srl reserves the right to alter the characteristics of products without notice. The values shown are nominal, with a +/- 1% tolerance for size, depending on the material, and a +/- 3% for weight.

	ARTICLE	WALLS		BOTTOM			HANDLES		GR.	PACKAGING		UNIT PRICE €
		Closed	Perforated	Closed	Perforated	Reinforced	Closed	Open		Qty. per pack.	Qty. per pallet	
♻️	A KL 4315 51G	■				■	■		1290	8	128	
♻️	B KL LI45 51G								279	4	640	
⚠️	ARTICLE ON REQUEST											
⚠️	A KL 4315 5207	■				■	■		1445	8	128	
⚠️	B KL LI45 5207								312	4	640	
	ACCESSORIES											
♻️	C KL PROT 5100								25	8		

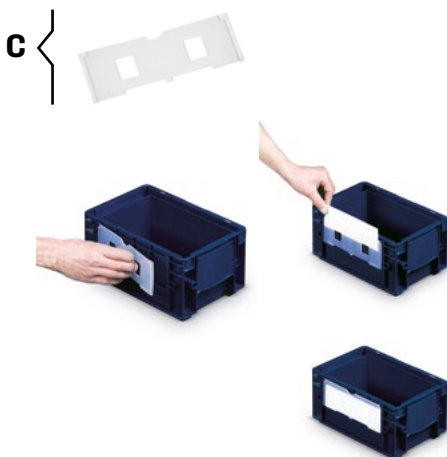
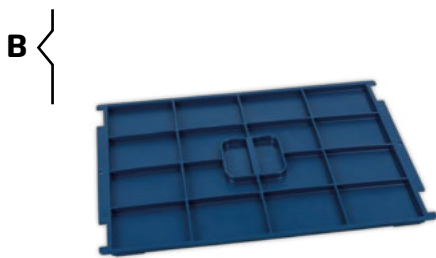
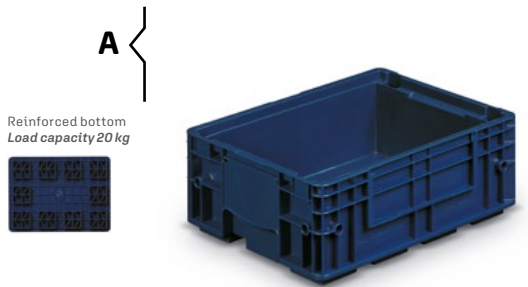

A	
Stacked edge height	132 mm
Usable stacked height / with lid	110 mm / 98 mm
Usable internal dimensions	345 x 264 x 124 H mm
Volume	10 L
Pieces per pack / pallet	📦 8 🚚 128
Package dimensions	620 x 420 x 563 H mm
Pallet dimensions	1200 x 800 x 2277 H mm
B	
Lid	400 x 300 mm
Pieces per pack. / dimension	📦 4 / 400 x 300 x 100 H mm
Pieces per pallet / dimension	🚚 640 / 1200 x 800 x 1000 H mm
C	
Semi-opaque label protection	150 x 67 H mm
Pieces per pack	📦 8

DATASHEET

iMilani srl reserves the right to alter the characteristics of products without notice. The values shown are nominal, with a +/- 1% tolerance for size, depending on the material, and a +/- 3% for weight.

⚠️ **ARTICLES ON REQUEST**  
 Minimum order.....200 boxes  
 Guaranteed shipping within.....60 days

# 400 x 300 mm H 280 mm

iMICUBE

4329

R-KLT

183

KLT

	ARTICLE	WALLS		BOTTOM			HANDLES		GR.	PACKAGING		UNIT PRICE €	
		Closed	Perforated	Closed	Perforated	Reinforced	Closed	Open		Qty. per pack.	Qty. per pallet		
A	KL 4329 511G	■				■	■		1850	4	64		♻️
B	KL LI45 511G								279	4	640		♻️
⚠️ ARTICLE ON REQUEST													
A	KL 4329 5207	■			■		■		2072	4	64		♻️
B	KL LI45 5207								312	4	640		♻️
ACCESSORIES													
C	KL PROT 5100								25	8			♻️



**A**

Reinforced bottom  
Load capacity 20 kg

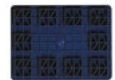

**B**



**C**

## DATASHEET

### A

Stacked edge height	265 mm
Usable stacked height / with lid	243 mm / 231 mm
Usable internal dimensions	345 x 264 x 257 H mm
Volume	22 L
Pieces per pack / pallet	📦 4 🚚 64
Package dimensions	620 x 420 x 565 H mm
Pallet dimensions	1200 x 800 x 2285 H mm

### B

Lid	400 x 300 mm
Pieces per pack. / dimension	📦 4 / 400 x 300 x 100 H mm
Pieces per pallet / dimension	🚚 640 / 1200 x 800 x 1000 H mm

### C

Semi-opaque label protection	150 x 67 H mm
Pieces per pack	📦 8

### ⚠️ ARTICLES ON REQUEST

Minimum order.....200 boxes  
Guaranteed shipping within.....60 days

iMilani srl reserves the right to alter the characteristics of products without notice. The values shown are nominal, with a +/- 1% tolerance for size, depending on the material, and a +/- 3% for weight.

	ARTICLE	WALLS		BOTTOM			HANDLES		GR.	PACKAGING		UNIT PRICE €
		Closed	Perforated	Closed	Perforated	Reinforced	Closed	Open		Qty. per pack.	Qty. per pallet	
	A KL 6415 51G	■				■	■		2100	4	64	
	B KL LI65 51G								680	4	240	
	ARTICLE ON REQUEST											
	A KL 6415 5207	■				■	■		2352	4	64	
	B KL LI65 5207								762	4	240	
	ACCESSORIES											
	C KL PROT 5100								25	8		

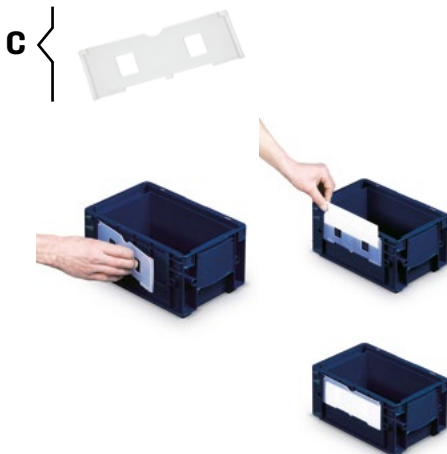
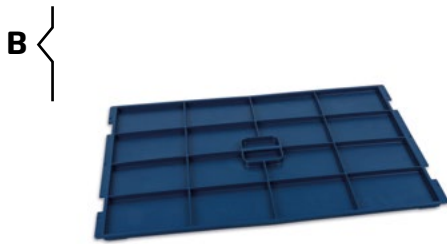
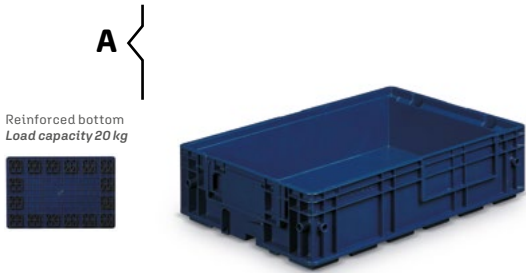

A	
Stacked edge height	132 mm
Usable stacked height / with lid	110 mm / 98 mm
Usable internal dimensions	543 x 363 x 124 H mm
Volume	22 L
Pieces per pack / pallet	4  64
Package dimensions	620 x 420 x 563 H mm
Pallet dimensions	1200 x 800 x 2277 H mm
B	
Lid	600 x 400 mm
Pieces per pack. / dimension	4 / 600 x 400 x 100 H mm
Pieces per pallet / dimension	240 / 1200 x 800 x 1000 H mm
C	
Semi-opaque label protection	210 x 74 H mm
Pieces per pack	8

DATASHEET

iMilani srl reserves the right to alter the characteristics of products without notice. The values shown are nominal, with a +/- 1% tolerance for size, depending on the material, and a +/- 3% for weight.

**ARTICLES ON REQUEST**  
 Minimum order.....200 boxes  
 Guaranteed shipping within.....60 days



# 600 x 400 mm H 280 mm

iMICUBE

6429

R-KLT

185

KLT

	ARTICLE	WALLS		BOTTOM			HANDLES		GR.	PACKAGING		UNIT PRICE €	
		Closed	Perforated	Closed	Perforated	Reinforced	Closed	Open		Qty. per pack.	Qty. per pallet		
A	KL 6429 511G	■				■	■		2970	2	32		♻️
B	KL LI65 511G								680	4	240		♻️
	ARTICLE ON REQUEST												
A	KL 6429 5207	■				■	■		3326	2	32		⚠️
B	KL LI65 5207								762	4	240		⚠️
	ACCESSORIES												
C	KL PROT 5100								25	8			♻️

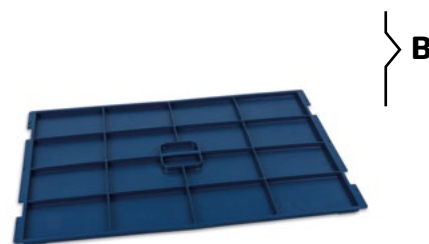
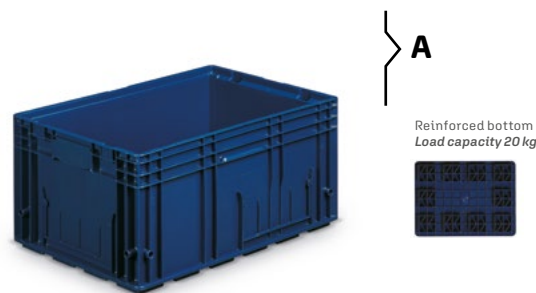

## DATASHEET

A	
Stacked edge height	265 mm
Usable stacked height / with lid	243 mm / 231 mm
Usable internal dimensions	543 x 363 x 257 H mm
Volume	48 L
Pieces per pack / pallet	📦 2 🚚 32
Package dimensions	620 x 420 x 565 H mm
Pallet dimensions	1200 x 800 x 2285 H mm
B	
Lid	600 x 400 mm
Pieces per pack. / dimension	📦 4 / 600 x 400 x 100 H mm
Pieces per pallet / dimension	🚚 240 / 1200 x 800 x 1000 H mm
C	
Semi-opaque label protection	150 x 67 H mm
Pieces per pack	📦 8

⚠️ **ARTICLES ON REQUEST**  
 Minimum order.....200 boxes  
 Guaranteed shipping within.....60 days

iMilani srl reserves the right to alter the characteristics of products without notice. The values shown are nominal, with a +/- 1% tolerance for size, depending on the material, and a +/- 3% for weight.



# R-KLT

The **R-KLT** series, created within the VDA - German Association of the Automotive Industry project, is ideally applied in the automotive industry, facilitating the movement of goods between the components industries and car manufacturers.

Good resistance to oils, various automated handling options, tough ergonomic handles, a high level of safety and strength and a reinforced bottom to withstand heavy loads.

# BOTTOMS

micube

300 x 200



400 x 300



600 x 400

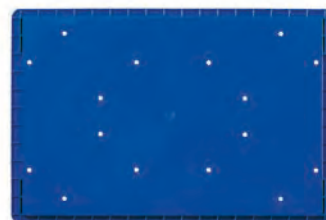

label holders  
on both sides



hand grip



holes for water drainage

stackable lower edge

slot for vertical bracing

closed bottom

stackable upper edge

centring hole

label holder

stable gripping surface  
for extraction in autom. warehouses

ergonomic handle

guides for frontal handling

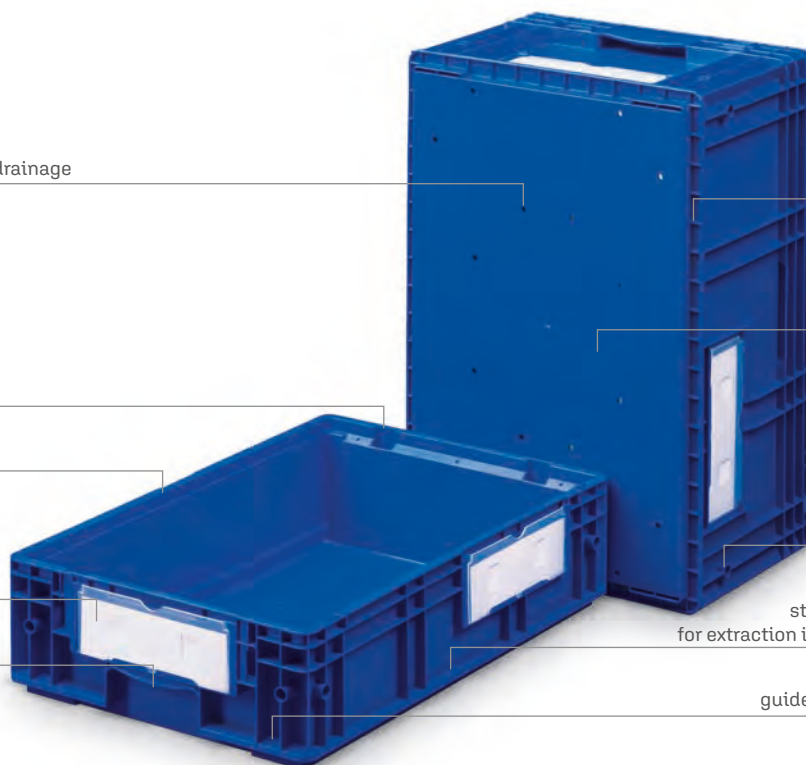

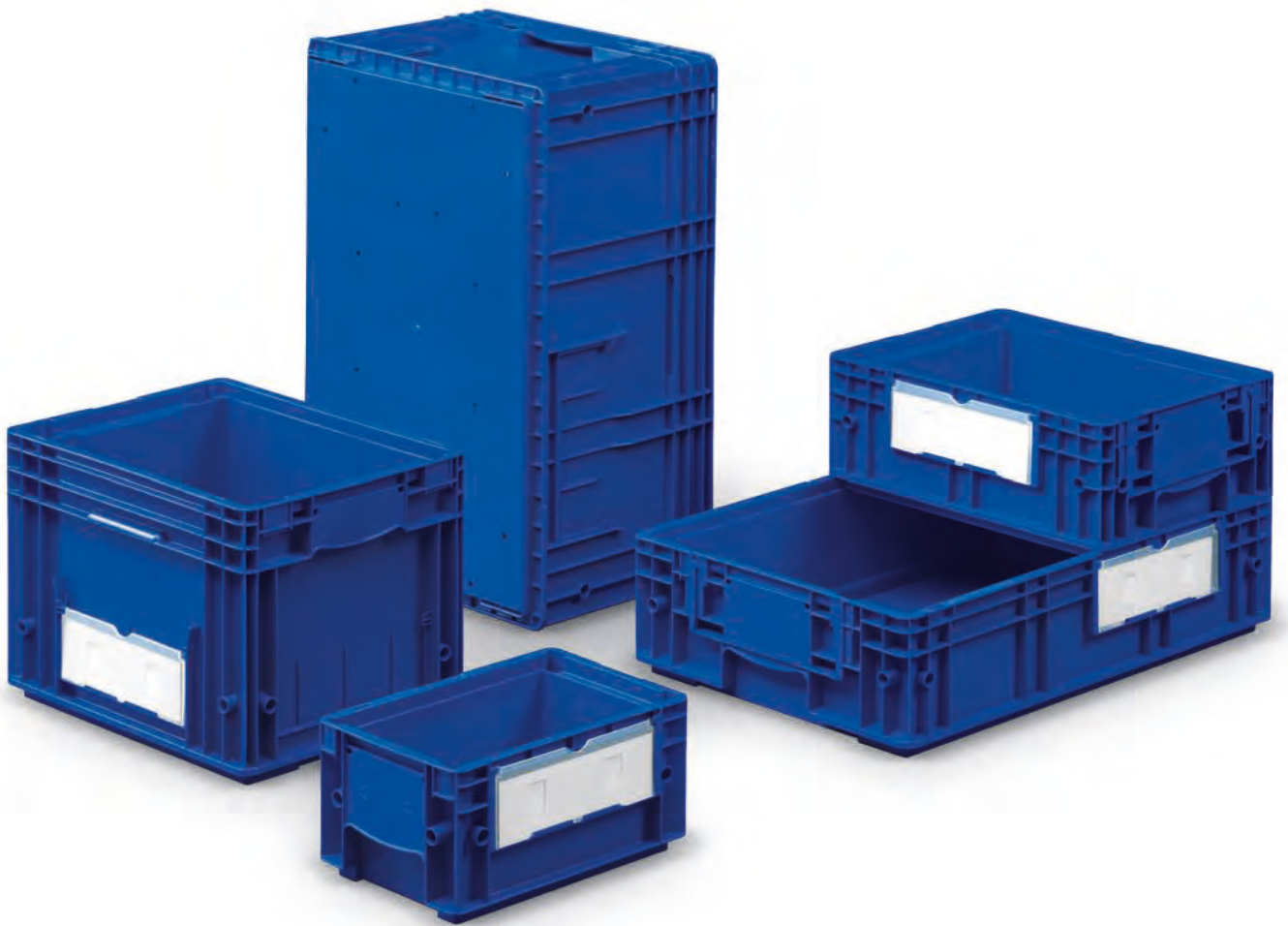

# 300 x 200 mm H 147 mm

iMICUBE

ARTICLE	WALLS		BOTTOM			HANDLES		GR.	PACKAGING		UNIT PRICE €
	Closed	Perforated	Closed	Perforated	Reinforced	Closed	Open		Qty. per pack.	Qty. per pallet	
A KL 3147 5127	-		-			-		570	16	256	
B KL LI35 5127								91	8	1280	
ARTICLE ON REQUEST											
A KL 3115 5207	-		-			-		638	16	256	
B KL LI31 5207								102	8	1280	
ACCESSORIES											
C KL PROT 5100								25	8		



**A**  
Closed bottom  
Load capacity 20 kg



**B**



**C**

## DATASHEET

A	
Stacked edge height	132 mm
Usable stacked height / with lid	127 mm / 116 mm
Usable internal dimensions	243 x 161 x 142 H mm
Volume	5,3 L
Pieces per pack / pallet	16  256
Package dimensions	620 x 420 x 563 H mm
Pallet dimensions	1200 x 800 x 2277 H mm
B	
Lid	300 x 200 mm
Pieces per pack. / dimension	8 / 300 x 200 x 150 H mm
Pieces per pallet / dimension	1280 / 1200 x 800 x 1000 H mm
C	
Semi-opaque label protection	150 x 67 H mm
Pieces per pack	8

**ARTICLES ON REQUEST**  
Minimum order.....200 boxes  
Guaranteed shipping within.....60 days

iMilani srl reserves the right to alter the characteristics of products without notice. The values shown are nominal, with a +/- 1% tolerance for size, depending on the material, and a +/- 3% for weight.

	ARTICLE	WALLS		BOTTOM			HANDLES		GR.	PACKAGING		UNIT PRICE €
		Closed	Perforated	Closed	Perforated	Reinforced	Closed	Open		Qty. per pack.	Qty. per pallet	
♻️ PP	A KL 4147 5127	-			-		-		1080	8	128	
♻️ PP	B KL LI45 5127								279	4	640	
⚠️	ARTICLE ON REQUEST											
⚠️	A KL 4047 5207	-			-		-		1210	8	128	
⚠️	B KL LI41 5207								312	4	640	
	ACCESSORIES											
♻️ PP	C KL PROT 5100								25	8		

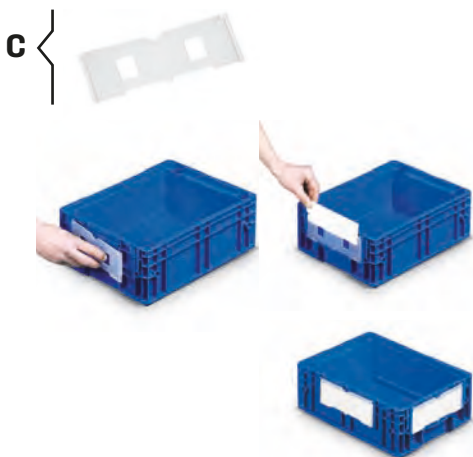
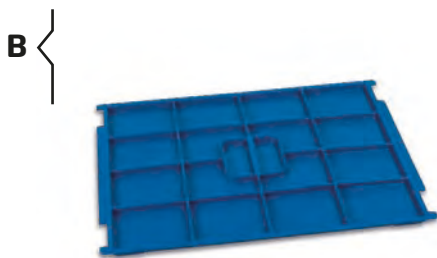

A	
Stacked edge height	132 mm
Usable stacked height / with lid	127 mm / 116 mm
Usable internal dimensions	346 x 262 x 142 H mm
Volume	11,8 L
Pieces per pack / pallet	📦 8 🚚 128
Package dimensions	620 x 420 x 563 H mm
Pallet dimensions	1200 x 800 x 2277 H mm
B	
Lid	400 x 300 mm
Pieces per pack. / dimension	📦 4 / 400 x 300 x 100 H mm
Pieces per pallet / dimension	🚚 640 / 1200 x 800 x 1000 H mm
C	
Semi-opaque label protection	150 x 67 H mm
Pieces per pack	📦 8

DATASHEET

iMilani srl reserves the right to alter the characteristics of products without notice. The values shown are nominal, with a +/- 1% tolerance for size, depending on the material, and a +/- 3% for weight.

⚠️ ARTICLES ON REQUEST  
Minimum order.....200 boxes  
Guaranteed shipping within.....60 days

# 400 x 300 mm H 280 mm

iMICUBE

	ARTICLE	WALLS		BOTTOM			HANDLES		GR.	PACKAGING		UNIT PRICE €	
		Closed	Perforated	Closed	Perforated	Reinforced	Closed	Open		Qty. per pack.	Qty. per pallet		
A	KL 4280 5127	-			-		-		1700	4	64		
B	KL LI45 5127								279	4	640		
⚠ ARTICLE ON REQUEST													
A	KL 4080 5207	-			-		-		1904	4	64		
B	KL LI41 5207								312	4	640		
ACCESSORIES													
C	KL PROT 5100								25	8			



**A**  
Perforated bottom  
Load capacity 20 kg



**B**



**C**

## DATASHEET

A	
Stacked edge height	265 mm
Usable stacked height / with lid	260 mm / 249 mm
Usable internal dimensions	346 x 262 x 275 H mm
Volume	24,1 L
Pieces per pack / pallet	4  64
Package dimensions	620 x 420 x 565 H mm
Pallet dimensions	1200 x 800 x 2285 H mm
B	
Lid	400 x 300 mm
Pieces per pack. / dimension	4 / 400 x 300 x 100 H mm
Pieces per pallet / dimension	640 / 1200 x 800 x 1000 H mm
C	
Semi-opaque label protection	150 x 67 H mm
Pieces per pack	8

⚠ ARTICLES ON REQUEST  
 Minimum order.....200 boxes  
 Guaranteed shipping within.....60 days

iMilani srl reserves the right to alter the characteristics of products without notice. The values shown are nominal, with a +/- 1% tolerance for size, depending on the material, and a +/- 3% for weight.

	ARTICLE	WALLS		BOTTOM			HANDLES		GR.	PACKAGING		UNIT PRICE €
		Closed	Perforated	Closed	Perforated	Reinforced	Closed	Open		Qty. per pack.	Qty. per pallet	
	A KL 6147 5127	-			-		-		1820	4	64	
	B KL LI65 5127								680	4	240	
	ARTICLE ON REQUEST											
	A KL 6047 5207	-			-		-		2038	4	64	
	B KL LI61 5207								762	4	240	
	ACCESSORIES											
	C KL PROT 5100								25	8		

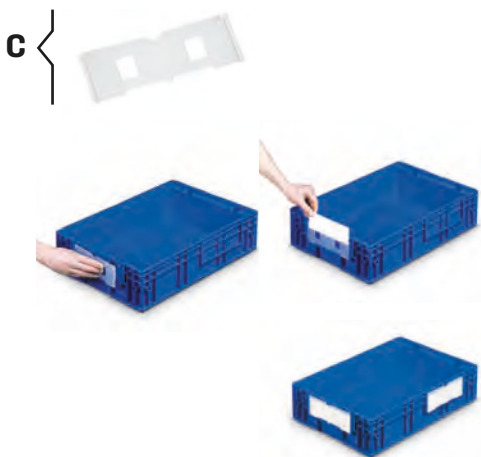
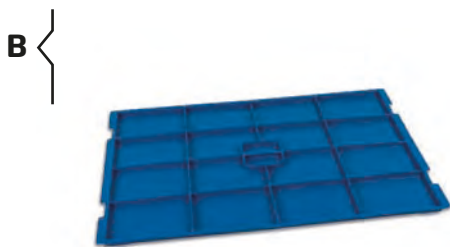

A	
Stacked edge height	132 mm
Usable stacked height / with lid	127 mm / 116 mm
Usable internal dimensions	543 x 358 x 142 H mm
Volume	25 L
Pieces per pack / pallet	4  64
Package dimensions	600 x 400 x 563 H mm
Pallet dimensions	1200 x 800 x 2277 H mm
B	
Lid	600 x 400 mm
Pieces per pack. / dimension	4 / 600 x 400 x 100 H mm
Pieces per pallet / dimension	240 / 1200 x 800 x 1000 H mm
C	
Semi-opaque label protection	150 x 67 H mm
Pieces per pack	8

DATASHEET

iMilani srl reserves the right to alter the characteristics of products without notice. The values shown are nominal, with a +/- 1% tolerance for size, depending on the material, and a +/- 3% for weight.

**ARTICLES ON REQUEST**  
Minimum order.....200 boxes  
Guaranteed shipping within.....60 days



# 600 x 400 mm H 280 mm

iMICUBE

	ARTICLE	WALLS		BOTTOM			HANDLES		GR.	PACKAGING		UNIT PRICE €	
		Closed	Perforated	Closed	Perforated	Reinforced	Closed	Open		Qty. per pack.	Qty. per pallet		
A	KL 6280 5127	-			-		-		2670	2	32		
B	KL LI65 5127								680	4	240		
	ARTICLE ON REQUEST												
A	KL 6080 5207	-			-		-		2990	2	32		
B	KL LI61 5207								762	4	240		
	ACCESSORIES												
C	KL PROT 5100								25	8			



**A**  
Perforated bottom  
Load capacity 20 kg



**B**

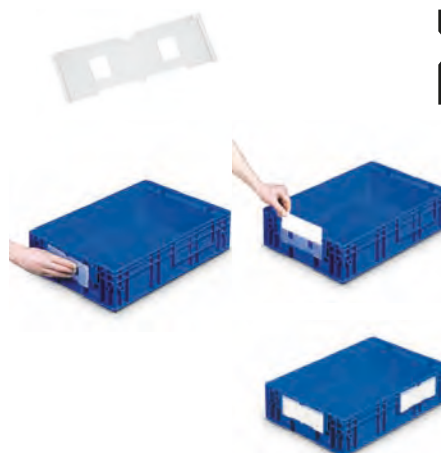

**C**

## DATASHEET

A	
Stacked edge height	265 mm
Usable stacked height / with lid	260 mm / 249 mm
Usable internal dimensions	543 x 358 x 275 H mm
Volume	51,9 L
Pieces per pack / pallet	2  32
Package dimensions	600 x 400 x 565 H mm
Pallet dimensions	1200 x 800 x 2285 H mm
B	
Lid	600 x 400 mm
Pieces per pack. / dimension	4 / 600 x 400 x 100 H mm
Pieces per pallet / dimension	240 / 1200 x 800 x 1000 H mm
C	
Semi-opaque label protection	150 x 67 H mm
Pieces per pack	8

**ARTICLES ON REQUEST**  
Minimum order.....200 boxes  
Guaranteed shipping within.....60 days

iMilani srl reserves the right to alter the characteristics of products without notice. The values shown are nominal, with a +/- 1% tolerance for size, depending on the material, and a +/- 3% for weight.

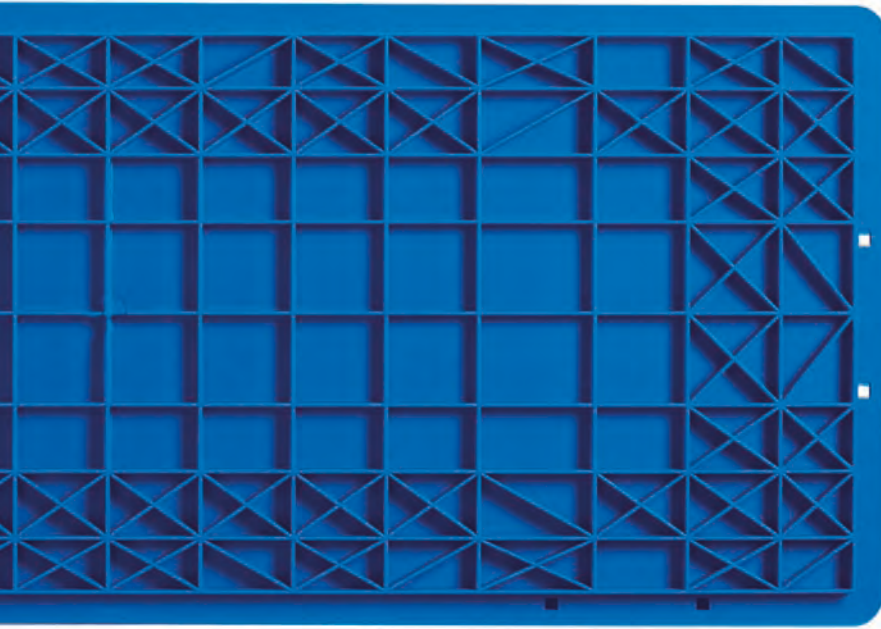

# 1000 x 400 mm H 214 mm

iMICUBE

ARTICLE	WALLS		BOTTOM			HANDLES		GR.	PACKAGING		UNIT PRICE €
	Closed	Perforated	Closed	Perforated	Reinforced	Closed	Open		Qty. per pack.	Qty. per pallet	
A KL 1421 5127	-				-	-		4000	9	33	



## DATASHEET

A	
Stacked edge height	199 mm
Usable stacked height / with lid	177 mm
Usable internal dimensions	935 x 345 x 191 H mm
Volume	63 L
Pieces per pack / pallet	9  33
Package dimensions	1200 x 1000 x 782 H mm
Pallet dimensions	1200 x 1000 x 2354 H mm



# 4618-KLT 4680-KLT

The **4618-KLT** and **4680-KLT** folding bins have been specifically designed and manufactured to significantly reduce their footprint when not in use and when transporting empty items. The reduction in volume up to 80% allows for considerable savings in terms of storage and handling costs.

Made of high grade polypropylene, the 4618-KLT and 4680-KLT folding bins are equipped with four folding walls hinged at the base, with several ribs at critical points: these structural features extend the bins' life span.

## HANDLES

lifting hole



## SIDE WALLS

folding walls



locking clips



## BOTTOM

perforated bottom



## STACKABILITY



## FOLDING SYSTEM



ARTICLE	WALLS		BOTTOM			HANDLES		GR.	PACKAGING		UNIT PRICE €	
	Closed	Perforated	Closed	Perforated	Reinforced	Closed	Open		Qty. per pack.	Qty. per pallet		
⚠ ARTICLE ON REQUEST												
A	KL	4618	5101		fl		fl		fl	2230	10	180
B	KL	4618	5127		fl		fl		fl	2230	10	180
C	KL	4618	51JV		fl		fl		fl	2230	10	180

Perforated bottom  
Load capacity 20 kg



Perforated bottom  
Load capacity 20 kg



Perforated bottom  
Load capacity 20 kg



A - B - C

Stacked edge height	48 mm
Usable stacked height	198 mm
Usable internal dimensions	547 x 359 x 215 H mm
Volume	42 L
Pieces per pack / pallet	📦 10 🚚 180
Package dimensions	620 x 425 x 560 H mm
Pallet dimensions	1200 x 800 x 2302 H mm

DATASHEET

iMilani srl reserves the right to alter the characteristics of products without notice. The values shown are nominal, with a +/- 1% tolerance for size, depending on the material, and a +/- 3% for weight.

⚠ ARTICLES ON REQUEST  
 Minimum order..... 500 boxes  
 Guaranteed shipping within.....60 days

# 600 x 400 mm H 280 mm

iMICUBE

ARTICLE	WALLS		BOTTOM			HANDLES		GR.	PACKAGING		UNIT PRICE €
	Closed	Perforated	Closed	Perforated	Reinforced	Closed	Open		Qty. per pack.	Qty. per pallet	
<b>⚠</b> ARTICLE ON REQUEST											
A KL 4680 5101		fl		fl			fl	2540	10	180	
B KL 4680 5127		fl		fl			fl	2540	10	180	
C KL 4680 51JV		fl		fl			fl	2540	10	180	

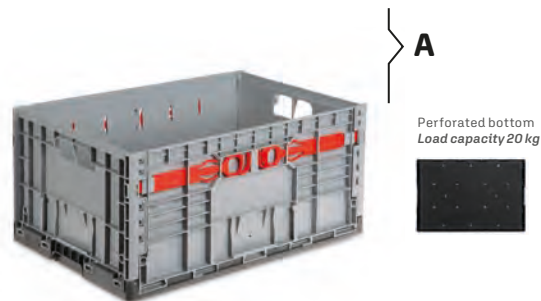

## DATASHEET

### A - B - C

Stacked edge height	48 mm
Usable stacked height	260 mm
Usable internal dimensions	547 x 359 x 277 H mm
Volume	54 L
Pieces per pack / pallet	10  180
Package dimensions	620 x 425 x 560 H mm
Pallet dimensions	1200 x 800 x 2302 H mm



#### ARTICLES ON REQUEST

Minimum order.....500 boxes  
Guaranteed shipping within.....60 days

iMilani srl reserves the right to alter the characteristics of products without notice. The values shown are nominal, with a +/- 1% tolerance for size, depending on the material, and a +/- 3% for weight.



# ODETTE

The distinctive yellow-coloured boxes of the **ODETTE** series were designed and built under the “Odette” project (Organisation for Data Exchange by Tele Transmission in Europe).

The organisation’s membership includes a number of important Italian and international companies, operating in particular in the automotive industry.

The Odette boxes came into being thanks to close cooperation with European car makers. The Odette project was launched Europe-wide in 1985 to create harmonised standards for containers for the handling and transport of small volumes or amounts.



# BOTTOM

1MICUBE

reinforced bottom

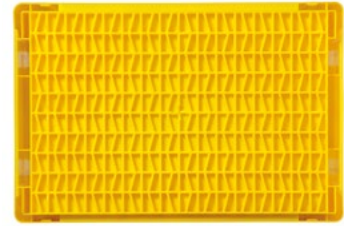

# PICKING

picking from above

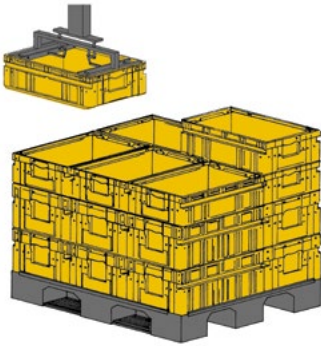

picking from below

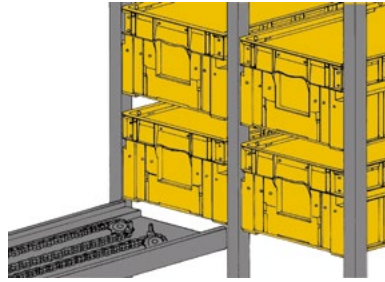

side picking

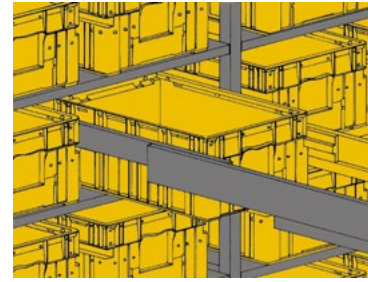

holes for vertical handling

holes for lid clips

side handle

bottom suitable for all types of roller beds

upper stacking edge

side guides for horizontal handling



guides for vertical handling

label holder



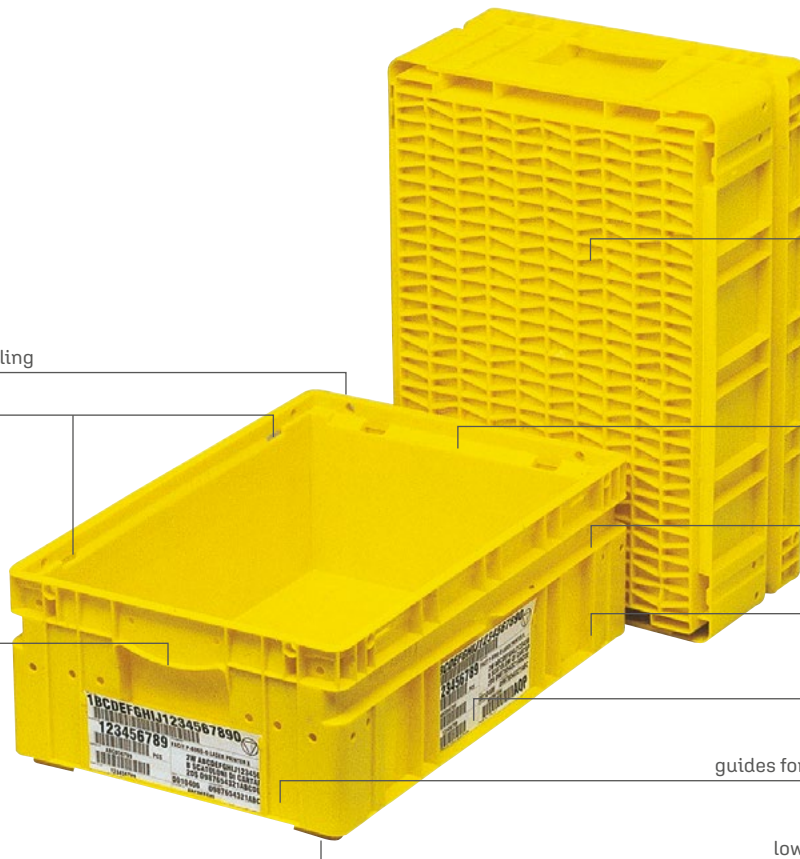

guides for frontal handling

lower stacking edge



ARTICLE	WALLS		BOTTOM			HANDLES		GR.	PACKAGING		UNIT PRICE €
	Closed	Perforated	Closed	Perforated	Reinforced	Closed	Open		Qty. per pack.	Qty. per pallet	
 A OD 4950 5105	■				■	■		600	16	256	
 B OD 32SE 5105								110	8	1440	
ACCESSORIES											
 C OD BEAM 0099									8		



A	
Stacked edge height	132 mm
Usable stacked height / with lid	118 mm / 107 mm
Usable internal dimensions	235 x 161 x 133 H mm
Volume	4,6 L
Pieces per pack / pallet	 16  256
Package dimensions	620 x 420 x 563 H mm
Pallet dimensions	1200 x 800 x 2277 H mm
B	
Lid	300 x 200 mm
Pieces per pack. / dimension	 8 / 300 x 200 x 160 H mm
Pieces per pallet / dimension	 1440 / 1200 x 800 x 1000 H mm
C	
Metal document holder rod	
Pieces per pack	 8



DATASHEET

# 400 x 300 mm H 214 mm

iMICUBE

ODETTE 4930



203

ARTICLE	WALLS		BOTTOM			HANDLES		GR.	PACKAGING		UNIT PRICE €
	Closed	Perforated	Closed	Perforated	Reinforced	Closed	Open		Qty. per pack.	Qty. per pallet	
A OD 4930 5105	■				■	■		1740	6	88	
B OD 43SE 5105								240	6	640	
ACCESSORIES											
C OD BEAM 0099									8		





## DATASHEET

### A

Stacked edge height	199 mm
Usable stacked height / with lid	185 mm / 174 mm
Usable internal dimensions	335 x 261 x 200 H mm
Volume	15,8 L
Pieces per pack / pallet	 6  88
Package dimensions	620 x 420 x 632 H mm
Pallet dimensions	1200 x 800 x 2354 H mm

### B

Lid	400 x 300 mm
Pieces per pack. / dimension	 6 / 400 x 300 x 120 H mm
Pieces per pallet / dimension	 640 / 1200 x 800 x 1000 H mm

### C

Metal document holder rod	
Pieces per pack	 8

iMilani srl reserves the right to alter the characteristics of products without notice. The values shown are nominal, with a +/- 1% tolerance for size, depending on the material, and a +/- 3% for weight.

OD

	ARTICLE	WALLS		BOTTOM			HANDLES		GR.	PACKAGING		UNIT PRICE €
		Closed	Perforated	Closed	Perforated	Reinforced	Closed	Open		Qty. per pack.	Qty. per pallet	
	A OD 4910 5105	■				■	■		2820	3	44	
	B OD 64SE 5105								500	3	320	
	ACCESSORIES											
	C OD BEAM 0099									8		

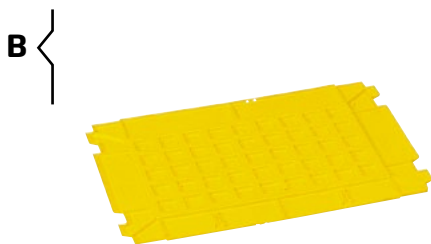

A	
Stacked edge height	199 mm
Usable stacked height / with lid	185 mm / 174 mm
Usable internal dimensions	535 x 361 x 200 H mm
Volume	34,8 L
Pieces per pack / pallet	3  44
Package dimensions	620 x 420 x 632 H mm
Pallet dimensions	1200 x 800 x 2354 H mm
B	
Lid	600 x 400 mm
Pieces per pack. / dimension	3 / 600 x 400 x 60 H mm
Pieces per pallet / dimension	320 / 1200 x 800 x 1000 H mm
C	
Metal document holder rod	
Pieces per pack	8



DATASHEET

# 600 x 400 mm H 314 mm

iMICUBE

ODETTE 4900

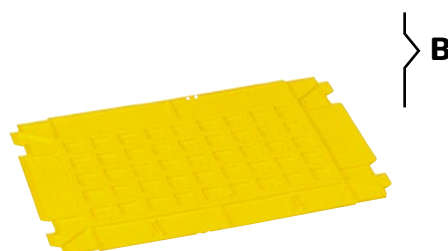
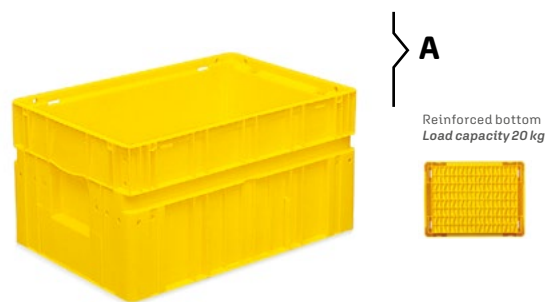

205

ARTICLE	WALLS		BOTTOM			HANDLES		GR.	PACKAGING		UNIT PRICE €
	Closed	Perforated	Closed	Perforated	Reinforced	Closed	Open		Qty. per pack.	Qty. per pallet	
A OD 4900 5105	■				■	■		4020	3	40	
B OD 64SE 5105							500	3	320		
ACCESSORIES											
C OD BEAM 0099								8			





## DATASHEET

### A

Stacked edge height	299 mm
Usable stacked height / with lid	285 mm / 274 mm
Usable internal dimensions	535 x 361 x 300 H mm
Volume	53 L
Pieces per pack / pallet	 3  40
Package dimensions	620 x 420 x 648 H mm
Pallet dimensions	1200 x 800 x 2369 H mm

### B

Lid	600 x 400 mm
Pieces per pack. / dimension	 3 / 600 x 400 x 60 H mm
Pieces per pallet / dimension	 320 / 1200 x 800 x 1000 H mm

### C

Metal document holder rod	
Pieces per pack	 8

iMilani srl reserves the right to alter the characteristics of products without notice. The values shown are nominal, with a +/- 1% tolerance for size, depending on the material, and a +/- 3% for weight.

OD

**ANTI-SLIP**

The particular pattern in relief on the upper part has a non-slip design, ensuring maximum grip even when wet.

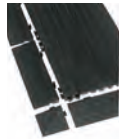
**SAFETY**

The linear and corner connecting ramps increase safety for operators using trolleys, ease the rolling of wheels and improve visual characteristics for accident prevention.

**WIRING**

The non-slip mats are suitable for the totally safe housing of electric cables laid on the floor.

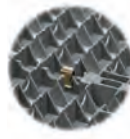
**CLIP**

All parts can be joined and removed quickly and easily by means of the special galvanised clip system.



LDPE

# MATS

These **MATS** are made of PE-LD (low density polyethylene) and are suitable especially in engineering workshops, metal processing industries, washing installations, food industries, warehouses, bathing facilities, campsites, wardrobes, etc.

The summary results of testing in the Plastics Centre of Southern Germany were as follows: the

mats showed good floor adherence both in no-load and full-load conditions; they did not form bevels (which may cause the user to stumble) or large gaps. Also, they remain equally usable in damp conditions as they have a raised surface.

ARTICLE	CLOSED WALKING SURFACE	PERFORATED WALKING SURFACE	GR.	PACKAGING		UNIT PRICE €	
				Qty. per pack.	Qty. per pallet		
CA 0804A 4101	-		1968	4	105		   
CA 0804A 4106	-		1968	4	105		
CA 0804A 4107	-		1968	4	105		
CA 0804A 4207	-		2339	4	105		
CA 0804B 4101		-	1979	4	105		  
CA 0804B 4106		-	1979	4	105		
CA 0804B 4107		-	1979	4	105		
<b>ACCESSORIES</b>							
CA 0401A 4105	-		240	20			 
CA 0401A 4207	-		269	20			
CA 0101A 4105	-		68	10			 
CA 0101A 4207	-		69	10			
E CA CLIP				10			



A

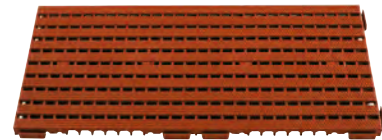

B



C



D



E

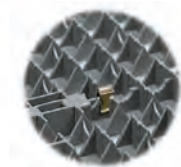

## DATASHEET

### A - CLOSED NON-SLIP MAT

Dimensions	800 x 400 x 25 H mm
Walking surface	without slots
Pieces per pack / pallet	4  105
Package dimensions	800 x 400 x 100 H mm
Pallet dimensions	1200 x 800 x 1025 H mm

### B - PERFORATED NON-SLIP MAT

Dimensions	800 x 400 x 25 H mm
Walking surface	with slots
Pieces per pack / pallet	4  105
Package dimensions	800 x 400 x 100 H mm
Pallet dimensions	1200 x 800 x 1025 H mm

### C - LINEAR CONNECTING RAMP FOR MAT

Dimensions	400 x 120 x 25 H mm
Pieces per pack	20

### D - CORNER CONNECTING RAMP FOR MAT

Dimensions	120 x 120 x 25 H mm
Pieces per pack	10

### E - GALVANISED CONNECTION CLIP

Pieces per pack	10
-----------------	----

iMilani srl reserves the right to alter the characteristics of products without notice. The values shown are nominal, with a +/- 1% tolerance for size, depending on the material, and a +/- 3% for weight.



# SAFELID

**SAFELID** is the safest, most versatile and affordable way to secure loads during transport. Available in 3 sizes – 800x600 mm, 1200x800 mm and 1200x1000 mm – SafeLid can be supplemented

with security seals, thus ensuring load inaccessibility. Also, there is no longer any need to use stretch film, thus increasing savings in time, cost and environmental protection.



# LOAD SAFETY

IMICUBE

extendible belt extraction



positioning of fixing hook



load securing with ratchet handle



# COMPONENTS

ratchet handle



lifting handle



extendible belt



# SEAL





800 x 600 mm H 93 mm

1200 x 800 mm H 100 mm

1200 x 1000 mm H 100 mm

	ARTICLE	2 SHORT SIDE STRAPS	2 LONG SIDE STRAPS	2 STRAPS ATTACHABLE ON EITHER SIDE	GR.	PACKAGING		UNIT PRICE €
						Qty. per pack.	Qty. per pallet	
A	SL 0806 5107	™			6150	1	60	
B	SL 1208 5107		™	™	10000	1	25	
C	SL 1210 5107		™	™	9930	1	25	



A

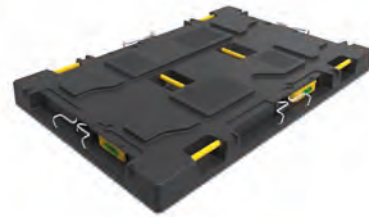

B



C

DATASHEET

A

Dimensions	822 x 618 x 93 H mm
Stacked edge height	62,5 mm
Maximum load weight	2000 kg
Operating temperature	-20C° / +40C°
Strap length	2000 mm
Pieces per pack / pallet	1  60
Package dimensions	850 x 650 x 120 H mm
Pallet dimensions	1200 x 800 x 1980 H mm

B

Dimensions	1210 x 810 x 100 H mm
Stacked edge height	71 mm
Maximum load weight	2000 kg
Operating temperature	-20C° / +40C°
Strap length	2000 mm
Pieces per pack / pallet	1  25
Package dimensions	1210 x 810 x 100 H mm
Pallet dimensions	1200 x 800 x 2200 H mm

C

Dimensions	1227 x 1027 x 100 H mm
Stacked edge height	71 mm
Maximum load weight	2000 kg
Operating temperature	-20C° / +40C°
Strap length	2000 mm
Pieces per pack / pallet	1  25
Package dimensions	1260 x 1060 x 130 H mm
Pallet dimensions	1250 x 1100 x 1930 H mm

iMilani srl reserves the right to alter the characteristics of products without notice. The values shown are nominal, with a +/- 1% tolerance for size, depending on the material, and a +/- 3% for weight.



# MOTION

**MOTION** is a trolley made of high-impact polypropylene and can be stacked when not in use. A simple coupling system means you can create rows of trolleys with a single movement. Available with black nylon wheels as standard.

Blue non-marking wheels are available on request. With the use of a top lid, it is also suitable for the transport of Delta boxes, stably and safely. To facilitate the transport of multiple trolleys, a height-adjustable telescopic drawbar is provided.

## COUPLING SYSTEM



The MOTION coupling system gives the option of connecting trolleys both on the short and long sides, enabling the user to shift more loads together or to prepare them for transport.

## SWIVEL WHEELS



The MOTION trolley is equipped with 4 thermoplastic swivel wheels as standard, 100 mm in diameter. Upon request, it is also possible to have TPR 75 mm diameter wheels in non-marking material, to help maintain the appearance of resin flooring.



Motion combination with Kronos



Motion combination with Delta



Motion combination with KLT



Motion combination with Odette

## STACKING

iMICUBE



The special design of the MOTION supporting surface allows trolleys to be stacked safely and stably, with cross-positioning of the various levels.

## BARCODE AND LOGO



A customisation option is available for a logo to be applied by hot marking on the sides of the MOTION trolley. There is also provision for 2 protected areas on each side of the MOTION trolley for the application of barcode labels or tags; they can be supplied together with the trolleys in accordance with the customer's specifications.

**600 x 400 mm H 173 mm****A****1****2****3**

ARTICLE	NYLON WHEELS DIAM. 100 MM	GR.	PACKAGING		UNIT PRICE €
			Qty. per pack.	Qty. per pallet	
A MO 64TP 5107	■	3540	1	64	<b>49,24</b>
<b>ACCESSORIES</b>					
1 MO HELM			1		<b>42,05</b>
2 DE 64SE 5101		960	1	160	<b>9,33</b>
3 MI 64SE 5101		1000	1	160	<b>7,82</b>

**A**

Dimensions	594 x 396 x 173 H mm
Cross-stacked inter-axle pitch	75 mm
In-line stacked inter-axle pitch	135 mm
Height from ground	117 mm
Type of wheels	4 swivel wheels
Wheel material as a standard	thermoplastic
Wheel diameter	100 mm
Wheel upper plate	in galvanised steel
Maximum No. of stacked units	1+15 trolleys
Load capacity kg	250
Pieces per pack / pallet	1  75
Pallet dimensions	1200 x 1000 x 2200 H mm

**1**

Height-adjustable telescopic drawbar

**2-3**

Lid for use with Delta/Minerva box	600 x 400 mm
Pieces per pack	1
Package dimensions	620 x 420 x 100 H mm

**DATASHEET**

# 800 x 600 mm H 196 mm

iMICUBE

ARTICLE	NYLON WHEELS DIAM.100 MM	NYLON WHEELS DIAM.80 MM	GR.	PACKAGING		UNIT PRICE €
				Qty. per pack.	Qty. per pallet	
A MO 86NY 5101	■	■	12000	1	20	247,95



2 swivel wheels and 2 fixed wheels



Locking system



A

## DATASHEET

A

Dimensions	800 x 600 x 196 H mm
Cross-stacked inter-axle pitch	75 mm
In-line stacked inter-axle pitch	196 mm
Height from ground	36 mm
Color	grey RAL7040
Material	High impact PP
Type of wheels	2 swivel wheels - 2 fixed wheels
Wheel material as a standard	nylon
Fixed wheels diameter	100 mm
Swivel wheels diameter	80 mm
Maximum No. of stacked units	1+15 trolleys
Load capacity kg	250
Pieces per pack / pallet	1  20
Pallet dimensions	1200 x 800 x 2110 H mm



Combination with 600X400 boxes

iMilani srl reserves the right to alter the characteristics of products without notice. The values shown are nominal, with a +/- 1% tolerance for size, depending on the material, and a +/- 3% for weight.



# CONTAINER

Injection moulded **CONTAINER** in High Density Polyethylene (HDPE), also suitable for food use. Fully recyclable material, initial melting guarantee and certification. Easy to clean and impervious to rust; insensitive to weight changes on contact with water.

Highly resistant to UV and infrared rays, high and low temperatures, acids and alkalis. Designed to be stackable, thus facilitating storage and handling operations.



## VERSIONS

ICUBE

with 4 feet



with 2 skids



with 4 wheels



## ACCESSORIES

separate lid



bar handle





# 1000 x 640 mm H 655 mm 1165 x 790 mm H 800 mm

iMICUBE

	ARTICLE	4 FEET	6 FEET WITH SKIDS	VIRGIN PE - HD	REGEN PE - HD	KG	PACKAGING		UNIT PRICE €
							Qty. per pack.	Qty. per pallet	
A	CN 1006FJ4001	■		■		14,3	1	6	
	CN 1006FJ4007	■			■	14,3	1	6	
B	CN 1107FJ 4001	■		■		25	1	3	
	CN 1107FJ 4007	■			■	25	1	3	
C	CN 1107SJ 4001		■	■		26,2	1	3	
	CN 1107SJ 4007		■		■	26,2	1	3	



Raw material for black articles: Regenerated High Density Polyethylene



A

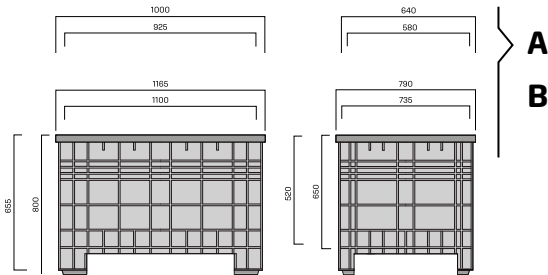

A  
B

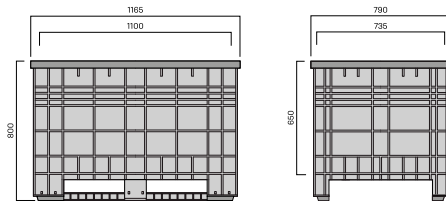

C

DATASHEET

A - CONTAINER WITH 4 FEET

Dimensions	1000 x 640 x 655 H mm
Internal dimensions	925 x 580 x 520 H mm
Load capacity	150 kg
Volume	280 L
Pieces per pack / pallet	1 6

B - CONTAINER WITH 4 FEET

Dimensions	1165 x 790 x 800 H mm
Internal dimensions	1100 x 735 x 650 H mm
Load capacity	250 kg
Volume	520 L
Pieces per pack / pallet	1 3

C - CONTAINER WITH 2 CROSSBARS

Dimensions	1165 x 790 x 800 H mm
Internal dimensions	1100 x 735 x 650 H mm
Load capacity	250 kg
Volume	520 L
Pieces per pack / pallet	1 3



B



C

iMilani srl reserves the right to alter the characteristics of products without notice. The values shown are nominal, with a +/- 1% tolerance for size, depending on the material, and a +/- 3% for weight.

**1000 x 640 mm H 790/815 mm**  
**1165 x 790 mm H 935/960 mm**



ARTICLE	WHEEL Ø 100 MM	WHEEL Ø 125 MM	OPTIONAL BAR HANDLE ATTACHMENT	WEIGHT WITHOUT WHEELS KG	PACKAGING		UNIT PRICE €
					Qty. per pack.	Qty. per pallet	
<b>A</b> CN 1006R1J 4001	■		■	14,3	1	6	
CN 1006R2J 4001		■	■	14,3	1	6	
<b>B</b> CN 1107R1J 4001	■		■	25,0	1	3	
CN 1107R2J 4001		■	■	25,0	1	3	

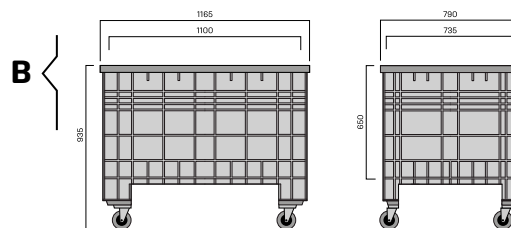
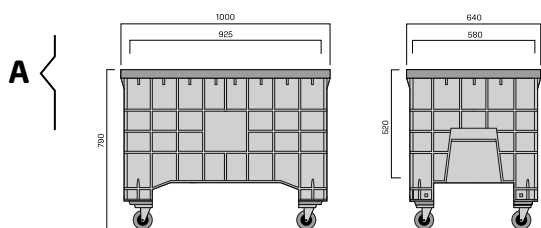

A	
Dimensions with wheels diam. 100 mm	1000 x 640 x 790 H mm
Dimensions with wheels diam. 125 mm	1000 x 640 x 815 H mm
Internal dimensions	925 x 580 x 520 H mm
Wheels without brake	4
Load capacity	150 kg
Volume	280 L
Pieces per pack / pallet	📦 1 🚚 6
B	
Dimensions with wheels diam. 100 mm	1165 x 790 x 935 H mm
Dimensions with wheels diam. 125 mm	1165 x 790 x 960 H mm
Internal dimensions	1100 x 735 x 650 H mm
Wheels without brake	4
Load capacity	250 kg
Volume	520 L
Pieces per pack / pallet	📦 1 🚚 3

DATASHEET

# 1200 x 1000 mm H 760 mm

iMICUBE

ARTICLE	4 FEET	9 FEET WITH 3 SKIDS	VIRGIN PE - HD	REGEN PE - HD	KG	PACKAGING		UNIT PRICE €
						Qty. per pack.	Qty. per pallet	
A CN 1210BJ 4001		■	■			1	3	



**Special container for collecting used batteries**  
Lid to be ordered separately

ARTICLE	FOR CONTAINER CN121...	FOR CONTAINER CN100...	FOR CONTAINER CN110...	GR.	PACKAGING		UNIT PRICE €
					Qty. per pack.	Qty. per pallet	
1 CN CV12 4001	■				1		
2 CN CV10 4001		■			1		
3 CN CV11 4001			■		1		
4 CN HAND480001		■			1		
CN HAND670001			■		1		

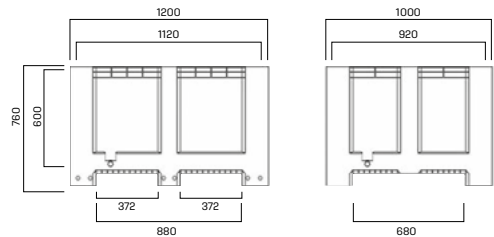

DATASHEET

**A - CONTAINER COLLECTION OF USED BATTERIES WITH 3 CROSSBARS**

Dimensions	1200 x 1000 x 760 H mm
Internal dimensions	1120 x 920 x 600 H mm
Load capacity	450 kg
Volume	610 L
Pieces per pack / pallet	📦 1 🚚 3

**1 - LID FOR COLLECTION OF USED BATTERIES**

Nominal dimensions	1200 x 1000 mm
Pieces per pack / pallet	📦 1 🚚 3

**2 - LID**

Nominal dimensions	1000 x 640 mm
Pieces per pack / pallet	📦 1 🚚 3

**3 - LID**

Nominal dimensions	1165 x 790 mm
Pieces per pack / pallet	📦 1 🚚 3

**4 - TRANSPORT HANDLES**

Length	480 mm / 670 mm
Pieces per pack / pallet	📦 1 🚚 3

iMilani srl reserves the right to alter the characteristics of products without notice. The values shown are nominal, with a +/- 1% tolerance for size, depending on the material, and a +/- 3% for weight.



# PALLET & LID

The **PALLET** was invented over 80 years ago, in the form of a simple wooden structure to be placed under material to facilitate handling.

Since then, much progress has been made, not only as regards vehicles but also in materials and geometrical research to make pallets endlessly reusable, easy to wash and producible in sustainable materials.

For increased load retention and safety, goods placed on pallets can be protected with the use of lids, of thermoforming or injection moulding construction.

## PALLET K SERIES

1MICUBE

This is a pallet with a new-generation monolithic structure without seams or joints, designed to improve the entire logistics process. It facilitates mechanical and manual handling and has been tested to ISO 8611-1991 standards.

It has excellent resistance to falls and is highly tolerant to twisting and pressure exerted from top to bottom and vice versa.

Made of 100% recyclable black polypropylene. The grid support surface facilitates cleaning.

Can be customised with hot marking, barcodes and RFID.



## PALLET J SERIES

Injection moulded pallet in High Density Polyethylene (HDPE) also suitable for food use, made of fully recyclable material, initial melting guarantee and certification.

Easy to clean and impervious to rust, insensitive to weight changes on contact with water.

Highly resistant to UV and infrared rays, high and low temperatures, acids and alkalis.

Can be customised with hot marking, barcodes and RFID.



## PALLET M SERIES

Made from recycled polyethylene, fully environmentally-friendly.

The M Series pallets can be inserted one inside the other, thanks to their specially designed feet.

It is available for light and medium loads. The light-load model is nevertheless very durable and can also be used as a disposable pallet.

The honeycomb structure surface of the medium-load model makes it suitable also for intensive use.

Both versions can be customised with hot marking, barcodes and RFID.



## LIDS

Available in 800x1200 mm and 1000x1200 mm sizes, they are made of high density polyethylene in the thermoforming version, which is lighter and more manageable, while polypropylene is used for the injection version.

Easily cleaned and reusable, they can be customised with hot marking, barcodes and RFID.



# 1200 x 800 mm 1200 x 1000 mm

ARTICLE	ATHENA ATHENA LIGHT KRONOS	RL-KLT R-KLT	ODETTE	KG	PACKAGING		UNIT PRICE €
					Qty. per pack.	Qty. per pallet	
A	PA 1208EK 5107	■		17,3	1	15	
B	PA 1210IK 5107		■	17,9	1	15	

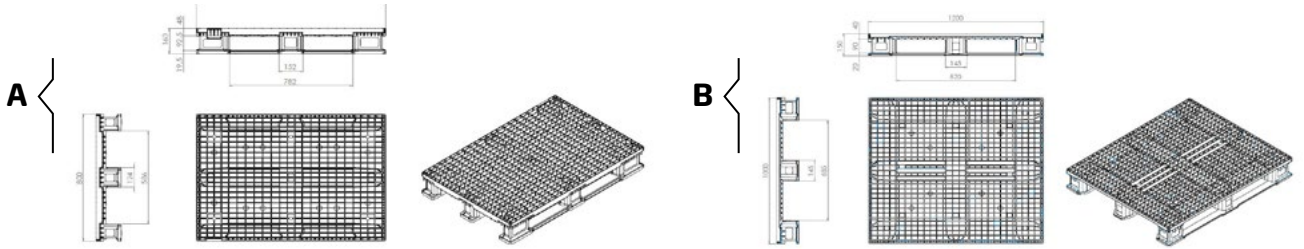

### A - PALLET WITH FLUSH EDGE

Dimensions	1200 x 800 x 160 H mm
Static load capacity	5000 kg
Dynamic load capacity	1500 kg
Pieces per pack / pallet	📦 1 🚚 15

### B - PALLET WITH RIM

Dimensions	1200 x 1000 x 160 H mm
Static load capacity	5000 kg
Dynamic load capacity	1500 kg
Pieces per pack / pallet	📦 1 🚚 15

DATASHEET



# 1200 x 800 mm 1200 x 1000 mm

iMICUBE

ARTICLE	ATHENA ATHENA LIGHT KRONOS	RL-KLT R-KLT	ODETTE	KG	PACKAGING		UNIT PRICE €
					Qty. per pack.	Qty. per pallet	
D PA 1208FJ 5100				12,3	1	15	
E PA 1210FJ 5100				15,1	1	15	
F PA 1208HJ 5100		■	■	14,5	1	15	
G PA 1210HJ 5100		■	■	17,0	1	15	
H PA 1208LJ 5100	■			14,0	1	15	
I PA 1210LJ 5100	■			16,9	1	15	



D  
E

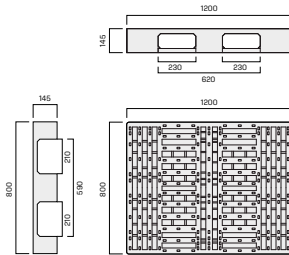

D  
F  
H

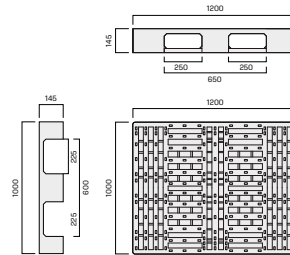

E  
G  
I

## DATASHEET

### D - PALLET WITHOUT RIM

Dimensions	1200 x 800 x 145 H mm
Static load capacity	4000 kg
Dynamic load capacity	1500 kg
Pieces per pack / pallet	1 15

### E - PALLET WITHOUT RIM

Dimensions	1200 x 1000 x 145 H mm
Static load capacity	4000 kg
Dynamic load capacity	1500 kg
Pieces per pack / pallet	1 15

### F - G PALLET WITH HIGH SECTION OUTER EDGE IN GALVANISED STEEL - FOR R-KLT - RL-KLT - ODETTE

Dimensions	1200 x 800/1000 x 145 H mm
Static load capacity	4000 kg
Dynamic load capacity	1500 kg
Pieces per pack / pallet	1 15

### H - I PALLET WITH LOW SECTION OUTER EDGE IN GALVANISED STEEL - FOR ATHENA - ATHENA LIGHT - KRONOS

Dimensions	1200 x 800/1000 x 145 H mm
Static load capacity	4000 kg
Dynamic load capacity	1500 kg
Pieces per pack / pallet	1 15



F  
G



H  
I

iMilani srl reserves the right to alter the characteristics of products without notice. The values shown are nominal, with a +/- 1% tolerance for size, depending on the material, and a +/- 3% for weight.

	ARTICLE	ATHENA ATHENA LIGHT KRONOS	RL-KLT R-KLT	ODETTE	KG	PACKAGING		UNIT PRICE €
						Qty. per pack.	Qty. per pallet	
	A	PA 1208LM 5107	■		4,8	1	66	
	B	PA 1210LM 5107	■		6,9	1	60	

Raw materials: Regenerated High Density Polyethylene

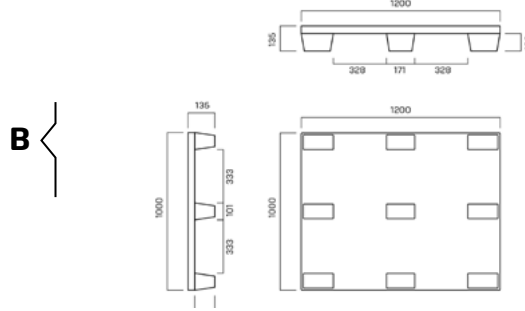
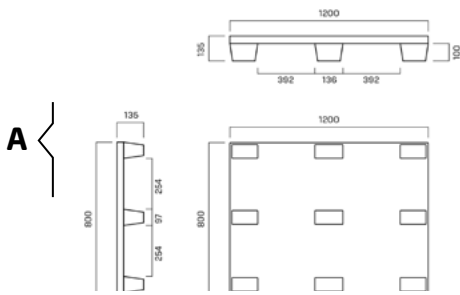

A	
Dimensions	1200 x 800 x 135 H mm
Static load capacity	1500 kg
Dynamic load capacity	600 kg
Pieces per pack / pallet	1  15

B	
Dimensions	1200 x 1000 x 135 H mm
Static load capacity	1500 kg
Dynamic load capacity	600 kg
Pieces per pack / pallet	1  60

**DATASHEET**

# 800 x 600 mm 1200 x 800 mm 1200 x 1000 mm

iMICUBE

	ARTICLE	ATHENA ATHENA LIGHT KRONOS	RL-KLT R-KLT	ODETTE	KG	PACKAGING		UNIT PRICE €	
						Qty. per pack.	Qty. per pallet		
D	PA 0806AM 5107	■	■		3,2	1	60		
E	PA 1208AM 5107	■	■		8,1	1	55		
F	PA 1210AM 5107	■	■		9,25	1	60		



Raw materials: Regenerated High Density Polyethylene

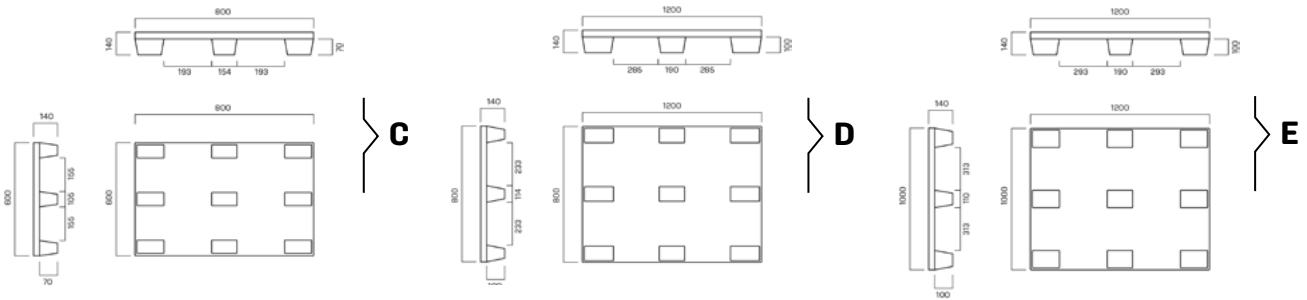

## DATASHEET

### C

Dimensions	800 x 600 x 140 H mm
Static load capacity	3000 kg
Dynamic load capacity	600 kg
Pieces per pack / pallet	1  60

### D

Dimensions	1200 x 800 x 140 H mm
Static load capacity	4000 kg
Dynamic load capacity	1200 kg
Pieces per pack / pallet	1  55

### E

Dimensions	1200 x 1000 x 140 H mm
Static load capacity	4000 kg
Dynamic load capacity	1200 kg
Pieces per pack / pallet	1  60





iMilani srl reserves the right to alter the characteristics of products without notice. The values shown are nominal, with a +/- 1% tolerance for size, depending on the material, and a +/- 3% for weight.





1200 x 800 mm  
1200 x 1000 mm

iMILCUBE



	ARTICLE	THERMOFORMING	INJECTION	KG	PACKAGING		UNIT PRICE €
					Qty. per pack.	Qty. per pallet	
A	CV 1208SC 5107		■	5770	1	20	
B	CV 1210SH 5107		■	7390	1	20	

DATASHEET

A

Nominal dimensions	1200 x 800 mm
Height space when in use	20 mm
Pieces per pack / pallet	 1  20
Pallet dimensions	1250 x 850 x 960 H mm

B - LID FOR USE SPECIFICALLY WITH R-KLT / RL-KLT / ODETTE

Nominal dimensions	1200 x 1000 mm
Height space when in use	20 mm
Pieces per pack / pallet	 1  20
Pallet dimensions	1250 x 1050 x 960 H mm



iMilani srl reserves the right to alter the characteristics of products without notice. The values shown are nominal, with a +/- 1% tolerance for size, depending on the material, and a +/- 3% for weight.



# HOLDER

## RS

rigid with support



ARTICLE	DIMENSIONS MM	FOR LABEL FORMAT MM	PRICE € PACK. 10 PCS
LH A414 RS	215 x 80 x 17 h	1/4 DIN A4 - 210 x 75	
LH A500 RS	215 x 155 x 17 h	DIN A5 - 210 x 148	

## RA

MICUBE

rigid with adhesive



ARTICLE	DIMENSIONS MM	FOR LABEL FORMAT MM	PRICE € PACK. 10 PCS
LH A700 RA	110 x 83	DIN A5 - 105 x 74	
LH A414 RA	220 x 83	1/4 DIN A4 - 210 x 75	
LH A500 RA	220 x 160	DIN A5 - 210 x 148	

## MI

soft i sersion



ARTICLE	DIMENSIONS MM	FOR LABEL FORMAT MM	PRICE € PACK. 10 PCS
LH A414 MI	210 x 80	1/4 DIN A4 - 210 x 75	
LH A413 MI	210 x 100	1/3 DIN A4 - 210 x 99	
LH A500 MI	210 x 147	DIN A5 - 210 x 148	

## MF

soft w th slot



ARTICLE	DIMENSIONS MM	FOR LABEL FORMAT MM	PRICE € PACK. 10 PCS
LH A414 MF	210 x 80	1/4 DIN A4 - 210 x 75	

## INSERTABLE LABEL FORMATS

DIN size in mm

DIN A7

110 x 83

1/4 DIN A4

210 x 75

1/3 DIN A4

210 x 99

DIN A5

210 x 160



LABEL HOLDER WITH SUPPORT



ARTICLE  
LH A414 RS



ARTICLE  
LH A500 RS

ART. NEXIT	ARTICLE LH A414 RS		ARTICLE LH A500 RS	
	EDGE 1/4 A4		EDGE A5	
	SHORT SIDE	LONG SIDE	SHORT SIDE	LONG SIDE
NX 2108 A	0	0	0	0
NX 2112 A	0	0	0	0
NX 3208 A	0	0	0	0
NX 3212 A	0	2	0	0
NX 3217 A	0	2	0	2
NX 3222 A	0	2	0	2
NX 4308 A	0	0	0	0
NX 4308 C	0	0	0	0
NX 4312 A	2	2	0	0
NX 4312 C	2	2	0	0
NX 4312 P	2	2	0	0
NX 4317 B	2	2	2	2
NX 4317 D	2	2	2	2
NX 4317 S	2	2	2	2
NX 4322 B	2	2	2	2
NX 4322 D	2	2	2	2
NX 4322 S	2	2	2	2
NX 4322 U	1	2	1	2
NX 4327 B	2	2	2	2
NX 4327 D	2	2	2	2
NX 4327 S	2	2	2	2
NX 4327 U	1	2	1	2
NX 4332 B	2	2	2	2
NX 4332 D	2	2	2	2
NX 4332 S	2	2	2	2
NX 4332 U	1	2	1	2

NOT APPLICABLE

NUMBER OF SIDES APPLICABLE  
WITHOUT THE USE OF THE HANDLE

NUMBER OF SIDES APPLICABLE





## LABEL HOLDER WITH SUPPORT



ARTICLE  
LH A414 RS

ARTICLE  
LH A500 RS

ART. NEXIT	EDGE 1/4 A4		EDGE A5	
	SHORT SIDE	LONG SIDE	SHORT SIDE	LONG SIDE
	NX 6408 A	0	0	0
NX 6408 C	0	0	0	0
NX 6408 P	0	0	0	0
NX 6412 A	2	2	0	0
NX 6412 C	2	2	0	0
NX 6412 P	2	2	0	0
NX 6417 B	2	2	2	2
NX 6417 D	2	2	2	2
NX 6417 S	2	2	2	2
NX 6422 B	2	2	2	2
NX 6422 D	2	2	2	2
NX 6422 S	2	2	2	2
NX 6422 U	1	2	1	2
NX 6427 B	2	2	2	2
NX 6427 D	2	2	2	2
NX 6427 S	2	2	2	2
NX 6427 U	1	2	1	2
NX 6432 B	2	2	2	2
NX 6432 D	2	2	2	2
NX 6432 S	2	2	2	2
NX 6432 U	1	2	1	2
NX 6442 B	2	2	2	2
NX 6442 D	2	2	2	2
NX 6442 S	2	2	2	2
NX 6442 U	1	2	1	2

NOT APPLICABLE

NUMBER OF SIDES APPLICABLE  
WITHOUT THE USE OF THE HANDLE

NUMBER OF SIDES APPLICABLE



LABEL HOLDER WITH ADHESIVE

NEXIT

234



ARTICLE  
LH A414 RA

ARTICLE  
LH A500 RA

ARTICLE  
LH A700 RA

ART. NEXIT	ADHESIVE 1/4 A4		ADHESIVE A5		ADHESIVE A7	
	SHORT SIDE	LONG SIDE	SHORT SIDE	LONG SIDE	SHORT SIDE	LONG SIDE
	NX 2108 A	0	0	0	0	0
NX 2112 A	0	0	0	0	0	0
NX 3208 A	0	0	0	0	0	0
NX 3212 A	0	0	0	0	0	0
NX 3217 A	0	0	0	0	2	2
NX 3222 A	0	0	0	0	2	2
NX 4308 A	0	0	0	0	0	0
NX 4308 C	0	0	0	0	0	0
NX 4312 A	0	0	0	0	0	0
NX 4312 C	0	0	0	0	0	0
NX 4312 P	0	0	0	0	0	0
NX 4317 B	0	2	0	0	2	2
NX 4317 D	0	2	0	0	2	2
NX 4317 S	0	0	0	0	0	2
NX 4322 B	0	2	0	2	0	2
NX 4322 D	0	2	0	2	0	2
NX 4322 S	0	0	0	0	0	2
NX 4322 U	0	2	0	2	1	2
NX 4327 B	2	2	0	2	2	2
NX 4327 D	2	2	0	2	2	2
NX 4327 S	2	2	0	0	2	2
NX 4327 U	1	2	0	2	2	2
NX 4332 B	2	2	2	2	2	2
NX 4332 D	2	2	2	2	2	2
NX 4332 S	2	2	2	0	2	2
NX 4332 U	1	2	1	2	2	2

NOT APPLICABLE

NUMBER OF SIDES APPLICABLE  
WITHOUT THE USE OF THE HANDLE

NUMBER OF SIDES APPLICABLE



## LABEL HOLDER WITH ADHESIVE



ARTICLE  
LH A414 RA

ARTICLE  
LH A500 RA

ARTICLE  
LH A700 RA

ART. NEXIT	ADHESIVE 1/4 A4		ADHESIVE A5		ADHESIVE A7	
	SHORT SIDE	LONG SIDE	SHORT SIDE	LONG SIDE	SHORT SIDE	LONG SIDE
	NX 6408 A	0	0	0	0	0
NX 6408 C	0	0	0	0	0	0
NX 6408 P	0	0	0	0	0	0
NX 6412 A	0	0	0	0	0	0
NX 6412 C	0	0	0	0	0	0
NX 6412 P	0	0	0	0	0	0
NX 6417 B	0	2	0	0	0	2
NX 6417 D	0	2	0	0	0	2
NX 6417 S	0	2	0	0	0	2
NX 6422 B	2	2	0	1	2	2
NX 6422 D	2	2	0	1	2	2
NX 6422 S	2	2	0	1	2	2
NX 6422 U	1	2	0	2	1	2
NX 6427 B	2	2	2	2	2	2
NX 6427 D	2	2	2	2	2	2
NX 6427 S	2	2	2	2	2	2
NX 6427 U	2	2	1	2	2	2
NX 6432 B	2	2	2	2	2	2
NX 6432 D	2	2	2	2	2	2
NX 6432 S	1	2	2	2	2	2
NX 6432 U	1	2	1	2	2	2
NX 6442 B	2	2	2	2	2	2
NX 6442 D	2	2	2	2	2	2
NX 6442 S	2	2	2	2	2	2
NX 6442 U	2	2	2	2	2	2

NOT APPLICABLE

NUMBER OF SIDES APPLICABLE  
WITHOUT THE USE OF THE HANDLE

NUMBER OF SIDES APPLICABLE



LABEL HOLDER WITH SUPPORT



ARTICLE  
LH A414 RS

ARTICLE  
LH A500 RS

ART. ATHENA	EDGE 1/4 A4		EDGE A5	
	SHORT SIDE	LONG SIDE	SHORT SIDE	LONG SIDE
	AT 3212 A	0	2	0
AT 3217 A	0	2	0	2
AT 4305 A	0	0	0	0
AT 4308 A	0	0	0	0
AT 4312 A	2	2	0	0
AT 4312 C	2	2	0	0
AT 4312 P	2	2	0	0
AT 4317 A	2	2	2	2
AT 4317 C	2	2	2	2
AT 4322 A	2	2	2	2
AT 4322 B	2	2	2	2
AT 4322 D	2	2	2	2
AT 4332 A	2	2	2	2
AT 4332 B	2	2	2	2
AT 6408 A	0	0	0	0
AT 6412 A	2	2	0	0
AT 6412 C	2	2	0	0
AT 6412 G	2	2	0	0
AT 6412 H	2	2	0	0
AT 6417 A	2	2	2	2
AT 6417 C	2	2	2	2
AT 6422 A	2	2	2	2
AT 6422 B	2	2	2	2
AT 6422 D	2	2	2	2
AT 6422 S	2	2	2	2
AT 6428 A	2	2	2	2
AT 6428 B	2	2	2	2
AT 6428 D	2	2	2	2
AT 6432 A	2	2	2	2
AT 6432 B	2	2	2	2
AT 6432 D	2	2	2	2
AT 6432 R	2	2	2	2
AT 6443 B	2	2	2	2
AT 6443 R	2	2	2	2
AT 6443 V	2	1	2	1
AT 6443 U	1	2	1	2
AT 8612 C	0	0	0	0
AT 8617 C	0	0	0	0
AT 8622 C	0	0	0	0
AT 8632 C	0	0	0	0
AT 8643 W	0	0	0	0

NOT APPLICABLE

NUMBER OF SIDES APPLICABLE  
WITHOUT THE USE OF THE HANDLE

NUMBER OF SIDES APPLICABLE



LABEL HOLDER WITH ADHESIVE



ARTICLE  
LH A414 RA

ARTICLE  
LH A500 RA

ARTICLE  
LH A700 RA

ART. ATHENA	ADHESIVE 1/4 A4		ADHESIVE A5		ADHESIVE A7	
	SHORT SIDE	LONG SIDE	SHORT SIDE	LONG SIDE	SHORT SIDE	LONG SIDE
	AT 3212 A	0	0	0	0	0
AT 3217 A	0	0	0	0	2	2
AT 4305 A	0	0	0	0	0	0
AT 4308 A	0	0	0	0	0	0
AT 4312 A	0	0	0	0	0	0
AT 4312 C	0	0	0	0	0	0
AT 4312 P	0	0	0	0	0	0
AT 4317 A	0	2	0	0	2	2
AT 4317 C	0	2	0	0	2	2
AT 4322 A	0	2	0	1	2	2
AT 4322 B	0	2	0	1	2	2
AT 4322 D	0	2	0	1	2	2
AT 4332 A	0	2	0	2	2	2
AT 4332 B	0	2	0	2	2	2
AT 6408 A	0	0	0	0	0	0
AT 6412 A	0	0	0	0	0	0
AT 6412 C	0	0	0	0	0	0
AT 6412 G	0	0	0	0	0	0
AT 6412 H	0	0	0	0	0	0
AT 6417 A	1	2	0	0	2	2
AT 6417 C	1	2	0	0	2	2
AT 6422 A	2	2	0	2	2	2
AT 6422 B	2	2	0	2	2	2
AT 6422 D	2	2	0	2	2	2
AT 6422 S	0	0	0	0	0	0
AT 6428 A	2	2	2	2	2	2
AT 6428 B	2	2	2	2	2	2
AT 6428 D	2	2	2	2	2	2
AT 6432 A	2	2	2	2	2	2
AT 6432 B	2	2	2	2	2	2
AT 6432 D	2	2	2	2	2	2
AT 6432 R	0	0	0	0	0	0
AT 6443 B	2	1	2	0	2	2
AT 6443 R	0	0	0	0	0	0
AT 6443 V	2	1	2	0	2	2
AT 6443 U	2	1	1	0	2	2
AT 8612 C	0	0	0	0	0	0
AT 8617 C	2	2	0	0	2	2
AT 8622 C	2	2	0	0	2	2
AT 8632 C	2	2	2	2	2	2
AT 8643 W	2	2	2	2	2	2

# ATHENA LIGHT BOX SERIES



## LABEL HOLDER WITH SUPPORT



ARTICLE  
LH A414 RS



ARTICLE  
LH A500 RS

ART. ATHENA LIGHT		
AL	6422	A
AL	6422	B
AL	6422	D

EDGE		1/4 A4	EDGE		A5
SHORT SIDE	LONG SIDE		SHORT SIDE	LONG SIDE	
2	2		2	2	
2	2		2	2	
2	2		2	2	



## LABEL HOLDER WITH ADHESIVE



ARTICLE  
LH A414 RA



ARTICLE  
LH A500 RA



ARTICLE  
LH A700 RA

ART. ATHENA LIGHT		
AL	6422	A
AL	6422	B
AL	6422	S

ADHESIVE		1/4 A4	ADHESIVE		A5	ADHESIVE		A7
SHORT SIDE	LONG SIDE		SHORT SIDE	LONG SIDE		SHORT SIDE	LONG SIDE	
1	0		0	0		2	2	
1	0		0	0		2	2	
0	0		0	0		0	0	

NOT APPLICABLE

NUMBER OF SIDES APPLICABLE  
WITHOUT THE USE OF THE HANDLE

NUMBER OF SIDES APPLICABLE

## LABEL HOLDER WITH SUPPORT



ARTICLE  
LH A414 RS

ARTICLE  
LH A500 RS

ART. ODETTE	EDGE 1/4 A4		EDGE A5	
	SHORT SIDE	LONG SIDE	SHORT SIDE	LONG SIDE
0 D 4 9 5 0	0	2	0	0
0 D 4 9 3 0	2	2	2	2
0 D 4 9 1 0	2	2	2	2
0 D 4 9 0 0	2	2	2	2

## LABEL HOLDER WITH ADHESIVE



ARTICLE  
LH A414 RA

ARTICLE  
LH A500 RA

ARTICLE  
LH A700 RA

ART. ODETTE	ADHESIVE 1/4 A4		ADHESIVE A5		ADHESIVE A7	
	SHORT SIDE	LONG SIDE	SHORT SIDE	LONG SIDE	SHORT SIDE	LONG SIDE
0 D 4 9 5 0	0	0	0	0	0	0
0 D 4 9 3 0	0	0	0	0	0	1
0 D 4 9 1 0	0	0	0	0	0	1
0 D 4 9 0 0	0	0	0	0	2	0

NOT APPLICABLE

NUMBER OF SIDES APPLICABLE  
WITHOUT THE USE OF THE HANDLE

NUMBER OF SIDES APPLICABLE



## LABEL HOLDER WITH SUPPORT



ARTICLE  
LH A414 RS



ARTICLE  
LH A500 RS

ART. RL-KLT	EDGE 1/4 A4		EDGE A5	
	SHORT SIDE	LONG SIDE	SHORT SIDE	LONG SIDE
	K L 3 1 4 7	0	2	0
K L 4 1 4 7	2	2	0	0
K L 4 2 8 0	2	2	2	2
K L 6 1 4 7	2	2	0	0
K L 6 2 8 0	2	2	2	2

## LABEL HOLDER WITH ADHESIVE



ARTICLE  
LH A414 RA



ARTICLE  
LH A500 RA



ARTICLE  
LH A700 RA

ART. RL-KLT	ADHESIVE 1/4 A4		ADHESIVE A5		ADHESIVE A7	
	SHORT SIDE	LONG SIDE	SHORT SIDE	LONG SIDE	SHORT SIDE	LONG SIDE
	K L 3 1 4 7	0	0	0	0	0
K L 4 1 4 7	0	0	0	0	0	1
K L 4 2 8 0	0	1	0	1	2	2
K L 6 1 4 7	0	0	0	0	0	2
K L 6 2 8 0	1	0	0	0	2	2

NOT APPLICABLE

NUMBER OF SIDES APPLICABLE  
WITHOUT THE USE OF THE HANDLE

NUMBER OF SIDES APPLICABLE





## LABEL HOLDER WITH SUPPORT



ARTICLE  
LH A414 RS

ARTICLE  
LH A500 RS

ART. R-KLT	EDGE 1/4 A4		EDGE A5	
	SHORT SIDE	LONG SIDE	SHORT SIDE	LONG SIDE
	K L 3 2 1 5	0	2	0
K L 4 3 1 5	2	2	0	0
K L 4 3 2 9	2	2	2	2
K L 6 4 1 5	2	2	0	0
K L 6 4 2 9	2	2	2	2



## LABEL HOLDER WITH ADHESIVE



ARTICLE  
LH A414 RA

ARTICLE  
LH A500 RA

ARTICLE  
LH A700 RA

ART. R-KLT	ADHESIVE 1/4 A4		ADHESIVE A5		ADHESIVE A7	
	SHORT SIDE	LONG SIDE	SHORT SIDE	LONG SIDE	SHORT SIDE	LONG SIDE
	K L 3 2 1 5	0	0	0	0	0
K L 4 3 1 5	0	0	0	0	0	0
K L 4 3 2 9	0	1	0	1	2	2
K L 6 4 1 5	0	0	0	0	0	0
K L 6 4 2 9	1	0	0	0	2	2

NOT APPLICABLE

NUMBER OF SIDES APPLICABLE  
WITHOUT THE USE OF THE HANDLE

NUMBER OF SIDES APPLICABLE

## LABEL HOLDER WITH SUPPORT



ARTICLE  
LH A414 RS



ARTICLE  
LH A500 RS

ART. MINERVA	EDGE 1/4 A4		EDGE A5	
	SHORT SIDE	LONG SIDE	SHORT SIDE	LONG SIDE
	MI 6420 B	0	0	0
MI 6420 S	0	0	0	0
MI 6430 B	0	2	0	0
MI 6430 S	0	2	0	0
MI 6440 B	0	2	0	0
MI 6440 S	0	2	0	0

## LABEL HOLDER WITH ADHESIVE



ARTICLE  
LH A414 RA



ARTICLE  
LH A500 RA



ARTICLE  
LH A700 RA

ART. MINERVA	ADHESIVE 1/4 A4		ADHESIVE A5		ADHESIVE A7	
	SHORT SIDE	LONG SIDE	SHORT SIDE	LONG SIDE	SHORT SIDE	LONG SIDE
	MI 6420 B	0	2	0	0	2
MI 6420 S	0	0	0	0	0	0
MI 6430 B	0	2	0	2	2	2
MI 6430 S	0	0	0	0	0	0
MI 6440 B	0	2	0	2	2	2
MI 6440 S	0	0	0	0	0	0

NOT APPLICABLE

NUMBER OF SIDES APPLICABLE

## LABEL HOLDER WITH SUPPORT



ARTICLE  
LH A414 RS

ARTICLE  
LH A500 RS

ART. DELTA	EDGE 1/4 A4		EDGE A5	
	SHORT SIDE	LONG SIDE	SHORT SIDE	LONG SIDE
	DE 6417 A	0	0	0
DE 6422 A	0	0	0	0
DE 6427 A	0	0	0	0
DE 6432 A	0	2	0	0
DE 6442 A	0	2	0	0
DE 6417 I	0	0	0	0
DE 6422 I	0	0	0	0
DE 6427 I	0	0	0	0
DE 6432 I	0	2	0	0
DE 6442 I	0	2	0	0
DE 6417 Z	0	0	0	0
DE 6422 Z	0	0	0	0
DE 6427 Z	0	0	0	0
DE 6432 Z	0	0	0	0
DE 6442 Z	0	0	0	0

## LABEL HOLDER WITH ADHESIVE



ARTICLE  
LH A414 RA

ARTICLE  
LH A500 RA

ARTICLE  
LH A700 RA

ART. DELTA	ADHESIVE 1/4 A4		ADHESIVE A5		ADHESIVE A7	
	SHORT SIDE	LONG SIDE	SHORT SIDE	LONG SIDE	SHORT SIDE	LONG SIDE
DE 6417 A	2	2	0	0	2	2
DE 6422 A	2	2	0	0	2	2
DE 6427 A	2	2	2	2	2	2
DE 6432 A	2	2	2	2	2	2
DE 6442 A	2	2	2	2	2	2
DE 6417 I	2	2	0	0	2	2
DE 6422 I	2	2	0	0	2	2
DE 6427 I	2	2	2	2	2	2
DE 6432 I	2	2	2	2	2	2
DE 6442 I	2	2	2	2	2	2
DE 6417 Z	2	2	0	0	2	2
DE 6422 Z	2	2	0	0	2	2
DE 6427 Z	2	2	2	2	2	2
DE 6432 Z	2	2	2	2	2	2
DE 6442 Z	2	2	2	2	2	2



LABEL HOLDER WITH ADHESIVE



ARTICLE  
LH A414 RA

ARTICLE  
LH A500 RA

ARTICLE  
LH A700 RA

ART. ZEUS	ADHESIVE 1/4 A4		ADHESIVE A5		ADHESIVE A7	
	SHORT SIDE	LONG SIDE	SHORT SIDE	LONG SIDE	SHORT SIDE	LONG SIDE
	Z E Z 0 0 2	0	0	0	0	0
Z E Z 3 A 2	0	2	0	0	0	2
Z E Z 4 A 2	1	2	0	0	1	2
Z E Z 0 0 4	1	2	0	2	1	2
Z E Z 4 A 5	1	2	1	2	1	2
Z E Z 0 0 5	0	0	0	0	2	2

NOT APPLICABLE

NUMBER OF SIDES APPLICABLE



LABEL HOLDER WITH ADHESIVE



ARTICLE  
LH A414 RA

ARTICLE  
LH A500 RA

ARTICLE  
LH A700 RA

ART. ZEUS COMPAT	ADHESIVE 1/4 A4		ADHESIVE A5		ADHESIVE A7	
	SHORT SIDE	LONG SIDE	SHORT SIDE	LONG SIDE	SHORT SIDE	LONG SIDE
	C O C O 0 1	0	0	0	0	0
C O C O 0 2	0	0	0	0	0	2
C O C 3 A 2	0	2	0	0	0	2
C O C O 0 3	0	2	0	2	0	2
C O Z 3 L 5	0	2	0	0	0	2
C O C 4 A 2	0	2	0	0	0	2
C O C O 0 4	0	2	0	2	0	2
C O C A 4 5	0	2	0	2	1	2
C O Z 5 P 4	0	0	0	0	1	2
C O Z O 0 5	0	0	0	0	1	2



NOT APPLICABLE



NUMBER OF SIDES APPLICABLE



# FOX

**FOX** trolleys are supplied complete with 2 shelves and NEXIT boxes or alternatively with 2 shelves and Compat containers.

Additional shelves complete with boxes and containers can be supplied separately.

Alternatively, FOX trolleys can also be ordered

complete with 2 groups of Practibox tilting containers.

Again, the trolley can be supplemented by ordering additional shelves equipped as per the user's needs.

The FOX trolley series is available with a height of 1430 mm and 2 different widths:

- Free span shelves 657 mm for FOX 06 trolleys
- Free span shelves 955 mm for FOX 08 trolleys

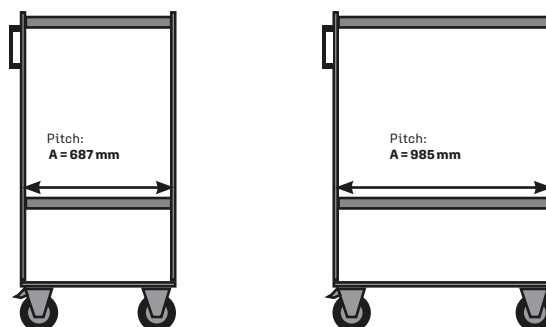

## SHELVES AND WHEELS



The tiltable shelves for FOX trolleys of length 955 mm and pitch 985 mm can be in 4 depths: 220, 320, 420 and 600 mm.

The tiltable shelves for FOX trolleys of length 657 mm and pitch 687 mm can be in 2 depths: 220 and 420 mm.

In addition to tilted shelves, the trolley is also configurable for fixed shelves for containers, with different depths available in both cases.

The trolleys are supplied as standard with mounted wheels and disassembled frame.

125 mm diameter rubber wheels, 2 fixed and 2 swivel with brakes, are supplied as standard.

## ACCESSORIES

To make the best use of the trolley spaces, optional accessories are available such as Practibox containers and reinforcing cross supports.



## ADJUSTMENTS

The perforated crosspiece base allows for adjustment of the uprights and the insertion of different types of boxes, giving maximum flexibility for installation of the smallest to the largest boxes.

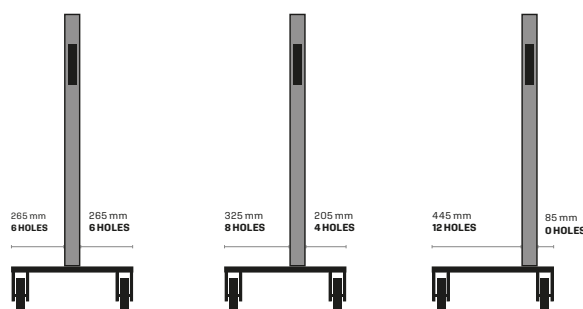

# 1023 x 613 mm H 1430mm

MICUBE

FOX  
248

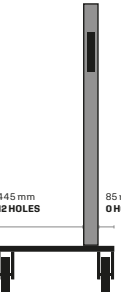
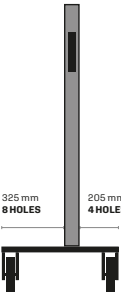
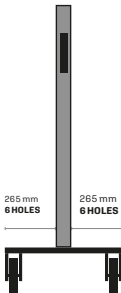



# 725 x 613 mm H 1430 mm

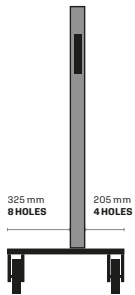
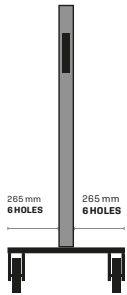

# 1023 x 613 mm H 1430mm

iMICUBE

FOX + COMPAT

250

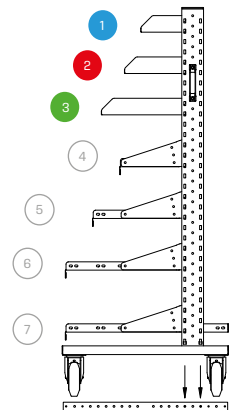
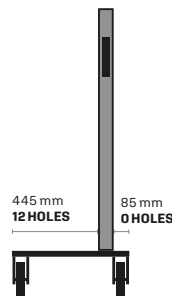
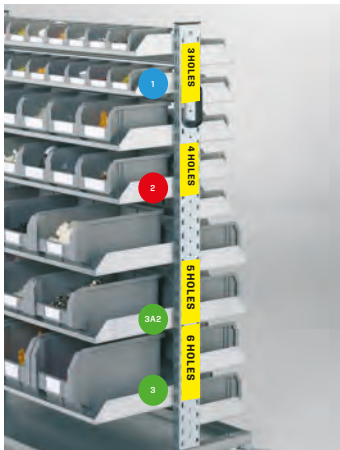
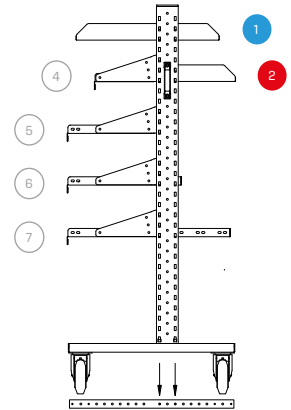
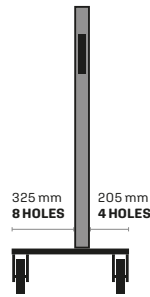
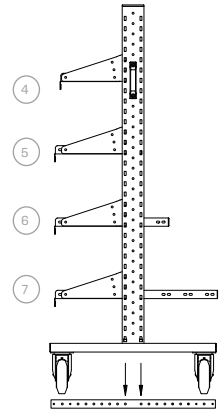
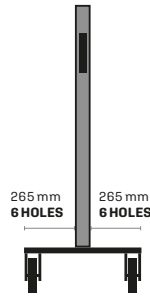

**974 x 150 mm****974 x 205 mm****974 x 295 mm**

## Shelves COMPAT containers













Fixed shelf in galvanised steel

Capacity 25 kg - L=974 mm

### KIT consisting of

- Trolley 1023 x 613 x 1430H mm

- 2 identical shelves complete with containers

SHELF DEPTH mm	NO. OF CONTAINERS	CONTAINER DIMENSIONS mm			MATERIAL	CODE	KIT PRICE €	CODE	PRICE OF ADDITIONAL SHELF WITH CONTAINERS €			
		L	P	H								
1  150	9	95	160/140	75		FXT 00199 5101		FX 00199 5101				
							FXT 00199 5102		FX 00199 5102			
							FXT 00199 5103		FX 00199 5103			
							FX T00199 5104		FX 00199 5104			
							FXT 00199 5105		FX 00199 5105			
		SIZE 1			ECOGREEN 	FXT 00199 5401		FX 00199 5401				
		2  205	6	140	230/200	130		FXT00269 5101		FX 00269 5101		
									FXT 00269 5102		FX 00269 5102	
									FXT 00269 5103		FX 00269 5103	
									FXT 00269 5104		FX 00269 5104	
	FXT 00269 5105								FX 00269 5105			
SIZE 2				ECOGREEN 	FXT 00269 5401		FX 00269 5401					
3  295	4			200	350/300	200		FXT 00349 5101		FX 00349 5101		
									FXT 00349 5102		FX 00349 5102	
									FXT 00349 5103		FX 00349 5103	
									FXT 00349 5104		FX 00349 5104	
			FXT 00349 5105						FX 00349 5105			
		SIZE 3			ECOGREEN 	FXT 00349 5401		FX 00349 5401				
		3  295	4	200	350/300	145		FXT 3A249 5101		FX 3A249 5101		
									FXT 3A249 5102		FX 3 A249 5102	
									FXT 3A249 5103		FX 3 A249 5103	
									FXT 3A249 5104		FX 3A249 5104	
	FXT 3A249 5105								FX 3A249 5105			
SIZE 3A2				ECOGREEN 	FXT 3A249 5401		FX 3A249 5401					

Load capacities are net and refer to evenly distributed loads.

The accessories and the materials stored in the truck must not protrude from the base of the truck.

# 1023 x 613 mm H 1430mm

MICUBE

FOX + NEXIT

252

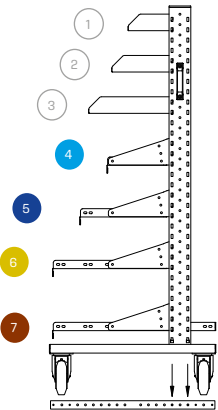
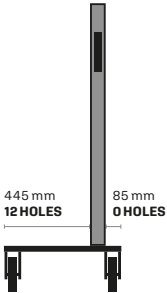
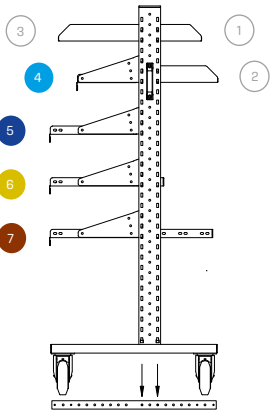
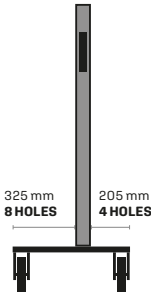
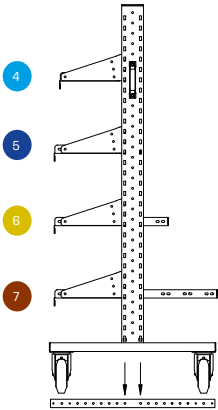
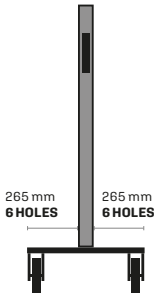

**955 x 220 mm - 955 x 320 mm**  
**955 x 420 mm - 955 x 600 mm**

## NEXIT box shelves

Tilttable shelf in galvanised steel

Load capacity 50 kg - L=955 mm

## KIT consisting of

- Trolley 1023 x 613 x 1430H mm

- 2 identical shelves complete with boxes

SHELF DEPTH mm	EXAMPLE	NO. OF BOXES	BOX DIMENSIONS mm			FRONT PICKING mm	MATERIAL	CODE	KIT PRICE €	CODE	PRICE OF ADDITIONAL SHELF WITH BOXES €
			L	P	H						
4 220		3	300	200	120	300	 FXT3212A39N101			FX3212A39N101	
							ECOGREEN 	FXT3212A39N401		FX3212A39N401	
		3	300	200	170	300	 FXT3217B39N101				FX3217B39N101
							ECOGREEN 	FXT3217B39N401		FX3217B39N401	
5 320		4	300	200	120	200	 FXT3212A49N101			FX3212A49N101	
							ECOGREEN 	FXT3212A49N401		FX3212A49N401	
		4	300	200	170	200	 FXT3217B49N101				FX3217B49N101
							ECOGREEN 	FXT3217B49N401		FX3217B49N401	
		2	400	300	120	400	 FXT4312A29N101				FX4312A29N101
							ECOGREEN 	FXT4312A29N401		FX4312A29N401	
		2	400	300	170	400	 FXT4317B29N101				FX4317B29N101
							ECOGREEN 	FXT4317B29N401		FX4317B29N401	
6 420		3	400	300	120	300	 FXT4312A39N101			FX4312A39N101	
							ECOGREEN 	FXT4312A39N401		FX4312A39N401	
		3	400	300	170	300	 FXT4317B39N101				FX4317B39N101
							ECOGREEN 	FXT4317B39N401		FX4317B39N401	
		3	400	300	220	300	 FXT4322B39N101				FX4322B39N101
							ECOGREEN 	FXT4322B39N401		FX4322B39N401	
	7 600		2	600	400	120	400	 FXT6412A29N101			FX6412A29N101
								ECOGREEN 	FXT6412A29N401		FX6412A29N401
2			600	400	170	400	 FXT6417B29N101				FX6417B29N101
							ECOGREEN 	FXT6417B29N401		FX6417B29N401	
2			600	400	220	400	 FXT6422B29N101				FX6422B29N101
							ECOGREEN 	FXT6422B29N401		FX6422B29N401	
		1	800	600	120	800	 FXT8612C195101				FX8612C195101
							ECOGREEN 	FXT8612C195401		FX8612C195401	
	1	800	600	170	800	 FXT8617C195101				FX8617C195101	
						ECOGREEN 	FXT8617C195401		FX8617C195401		
1	800	600	220	800	 FXT8622C195101				FX8622C195101		
					ECOGREEN 	FXT8622C195401		FX8622C195401			

Load capacities are net and refer to evenly distributed loads.

The accessories and the materials stored in the truck must not protrude from the base of the truck.

# 725 x 613 mm H 1430mm

¡MICUBE

FOX + COMPAT

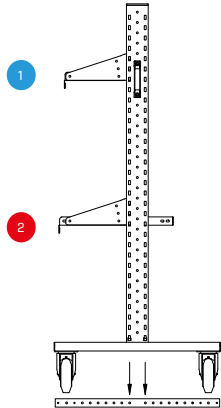
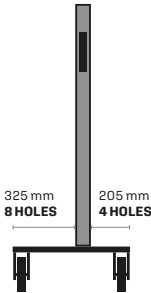
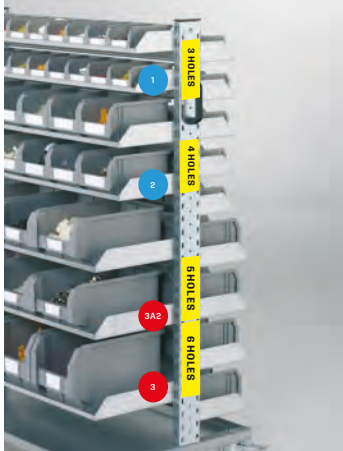
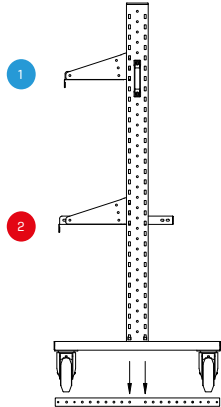
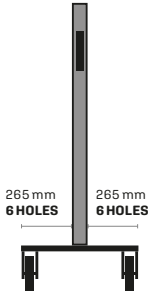

**657 x 220 mm**  
**657 x 420 mm**

## Shelves COMPAT containers













Tiltable shelf in galvanised steel

Capacity 50 kg - L=657 mm

### KIT consisting of

- Trolley 725 x 613 x 1430H mm

- 2 identical shelves complete with containers

SHELF DEPTH mm	NO. OF CONTAINERS	CONTAINER DIMENSIONS mm			MATERIAL	CODE	KIT PRICE €	CODE	PRICE OF ADDITIONAL SHELF WITH CONTAINERS €		
		L	P	H							
1 220	6	95	160/140	75		FXT 00166 5101		FX 00166 5101			
						FXT 00166 5102		FX 00166 5102			
						FXT 00166 5103		FX 00166 5103			
						FXT 00166 5104		FX 00166 5104			
						FXT 00166 5105		FX 00166 5105			
		SIZE 1			ECOGREEN 	FXT 00166 5401		FX 00166 5401			
		1 220	4	140	230/200	130		FXT 00246 5101		FX 00246 5101	
								FXT 00246 5102		FX 00246 5102	
								FXT 00246 5103		FX 00246 5103	
								FXT 00246 5104		FX 00246 5104	
FXT 00246 5105								FX 00246 5105			
SIZE 2				ECOGREEN 	FXT 00246 5401		FX 00246 5401				
2 420	3			200	350/300	200		FXT 00336 5101		FX 00336 5101	
								FXT 00336 5102		FX 00336 5102	
								FXT 00336 5103		FX 00336 5103	
								FXT 00336 5104		FX 00336 5104	
		FXT 00336 5105						FX 00336 5105			
		SIZE 3			ECOGREEN 	FXT 00336 5401		FX 00336 5401			
		2 420	3	200	350/300	145		FXT 3A236 5101		FX 3A236 5101	
								FXT 3A236 5102		FX 3A236 5102	
								FXT 3A236 5103		FX 3A236 5103	
								FXT 3A236 5104		FX 3A236 5104	
FXT 3A236 5105								FX 3A236 5105			
SIZE 3A2				ECOGREEN 	FXT 3A236 5401		FX 3A236 5401				

Load capacities are net and refer to evenly distributed loads.

The accessories and the materials stored in the truck must not protrude from the base of the truck.

# 725 x 613 mm H 1430mm

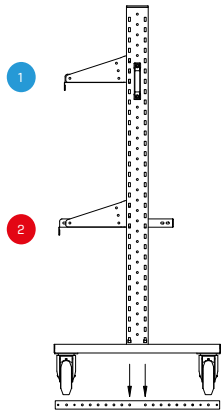
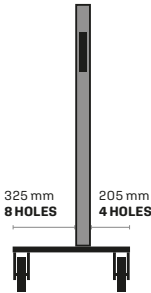
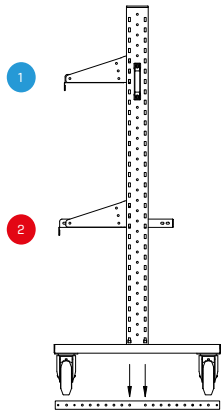
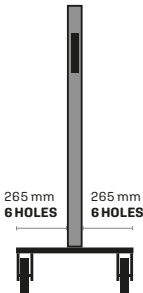



**657 x 220 mm**  
**657 x 420 mm**

## NEXIT box shelves















Tilttable shelf in galvanised steel

Load capacity 50 kg - L=657 mm

## KIT consisting of

- Trolley 725 x 613 x 1430H mm

- 2 identical shelves complete with boxes

SHELF DEPTH mm	EXAMPLE	NO. OF BOXES	BOX DIMENSIONS mm			FRONT PICKING mm	MATERIAL	CODE	KIT PRICE €	CODE	PRICE OF ADDITIONAL SHELF WITH BOXES €		
			L	P	H								
220		2	300	200	120	300	 PP	FXT 3212A26 N101		FX 3212A26 N101			
							ECOGREEN 	FXT 3212A26 N401		FX 3212A26 N401			
		2	300	200	170	300	 PP	FXT 3217B26 N101		FX 3217B26 N101			
							ECOGREEN 	FXT 3217B26 N401		FX 3217B26 N401			
420		2	400	300	120	300	 PP	FXT4312A26N101		FX 4312A26 N101			
							ECOGREEN 	FXT 4312A26 N401		FX 4312A26 N401			
		2	400	300	170	300	 PP	FXT 4317B26 N101		FX 4317B26 N101			
							ECOGREEN 	FXT 4317B26 N401		FX 4317B26 N401			
		2	400	300	220	300	 PP	FXT 4322B26 N101		FX 4322B26 N101			
							ECOGREEN 	FXT 4322B26 N401		FX 4322B26 N401			
		1		1	600	400	120	600	 PP	FXT 6412A16 N101		FX 6412A16 N101	
									ECOGREEN 	FXT 6412A16 N401		FX 6412A16 N401	
				1	600	400	170	600	 PP	FXT 6417B16 N101		FX 6417B16 N101	
									ECOGREEN 	FXT 6417B16 N401		FX 6417B16 N401	
				1	600	400	220	600	 PP	FXT 6422B16 N101		FX 6422B16 N101	
									ECOGREEN 	FXT 6422B16 N401		FX 6422B16 N401	

# 725 x 613 mm H 1430mm

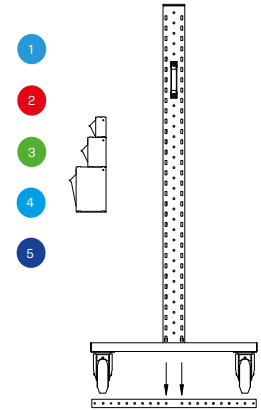
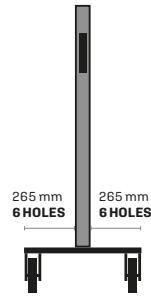

Rail total height

**1200 mm - 280 mm**

IMICUBE







Usable insertion height of Practibox

**1264 mm - 276 mm**

**KIT consisting of**

- Trolley 725 x 613 x H 1430 mm
- 2 pairs of rails height 1200
- 2 Practibox drawers
- 2 galvanised stops

 For each additional Practibox drawer unit, always order the relevant stops shown on page 139 position D

RAILS HEIGHT mm	PRACTIBOX RAILS				CODE	PRICE €
Total H.					FXRAIL12	
1200						
Usable H.						
Total H.					FXRAIL28	
280						
Usable H.						
HEIGHT mm	PRACTIBOX DRAWER UNIT	NO. TILTING PIECES	CODE	KIT PRICE €	CODE	PRICE € ADDITIONAL PRACTIBOX
77		9	FXTPR9		PR90770001	
112		6	FXTPR6		PR61120001	
164		5	FXTPR5		PR51640001	
206		4	FXTPR4		PR42060001	
240		3	FXTPR3		PR3240001	



# QUICK

**QUICK** shelf units are supplied complete with 2 shelves and NEXIT boxes or alternatively with 2 shelves and Compat containers.

Additional shelves complete with boxes and containers can be supplied separately.

QUICK shelf units make picking operations more efficient, reducing the frequency errors and providing high visibility of stocks.

The QUICK series shelf unit, with a height of 1817 mm, is available with two different solutions: single-sided and double-sided, allowing insertion of shelves on one or both sides.

double-sided frame with cross support



single-sided frame with cross support

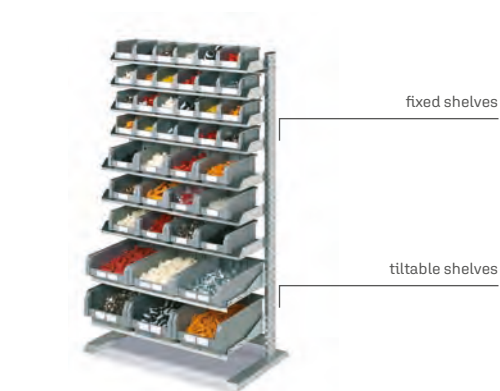

The tiltable shelves for QUICK shelf units of length 955 mm and pitch 985 mm are available in 4 depths: 220 - 320 - 420 - 600 mm.

In addition to tilted shelves, the trolley is also configurable for fixed shelves for containers, with different depths available in both cases.

## BOXES AND CONTAINERS

The slots in the uprights allow the use of different types of containers including COMPAT sizes 1/2/3/3A2/4/4A2 and NEXIT series boxes.

COMPAT



NEXIT



## ADDITIONAL SHELF UNITS

With additional shelves it is possible to connect a new bay to the existing one, thus saving space and the cost of an additional upright and foot.



1065 x 542 mm H 1813mm

MICUBE

QUICK

262



Shelf dimensions

**1065 x 925 mm H 1813 mm**

1MICUBE



**1065 x 542 mm H 1813mm**

MICUBE

**QUICK + COMPAT**

264

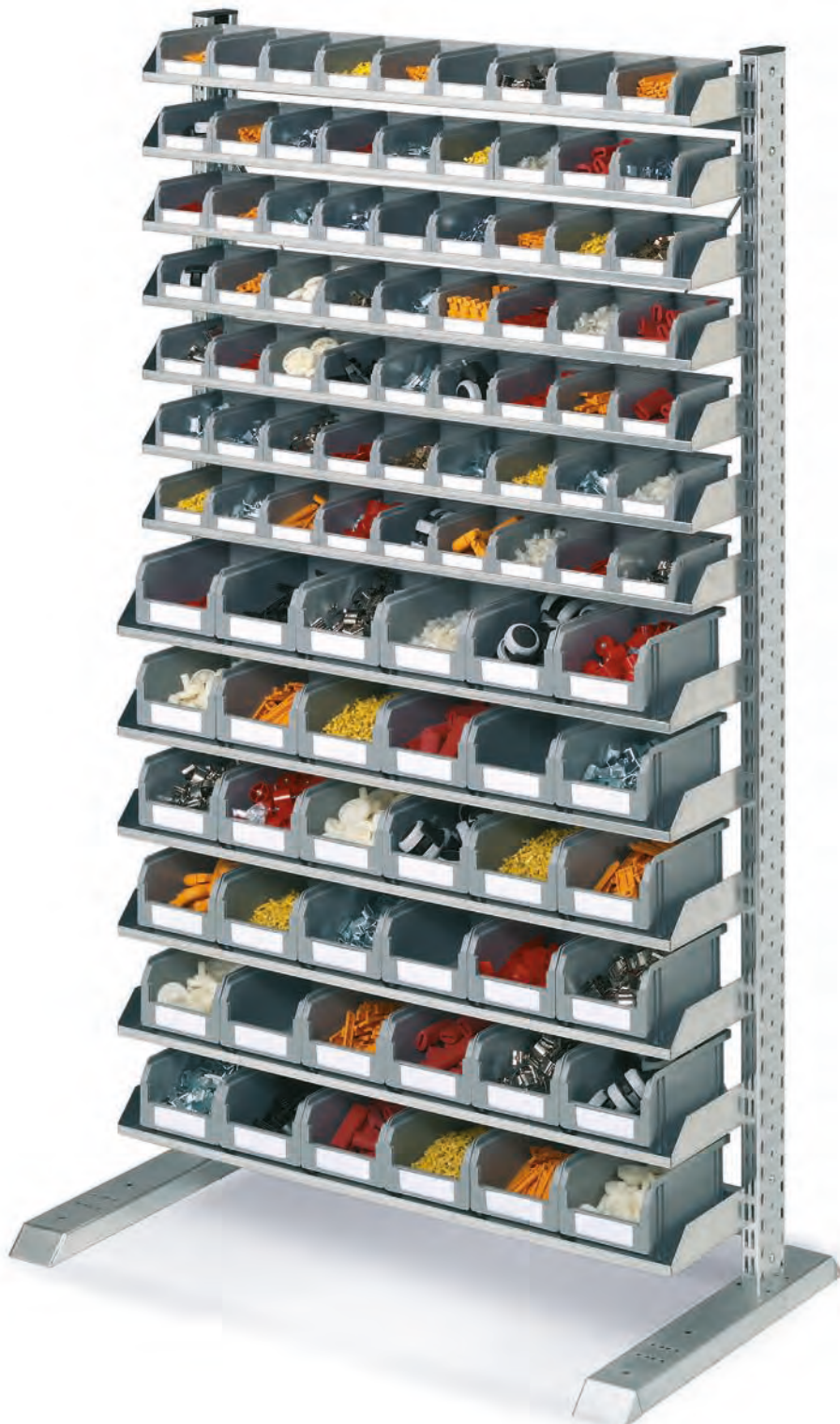



## Shelves COMPAT containers

Fixed shelf in galvanised steel

Capacity 25 kg - L=974 mm

### KIT consisting of

- Shelft unit 1065 x 542 x 1813H mm

- 2 identical shelves complete with containers

SHELFDEPTH mm	NO. OF CONTAINERS	CONTAINER DIMENSIONS mm			MATERIAL	CODE	KIT PRICE €	CODE	PRICE OF ADDITIONAL SHELF WITH CONTAINERS €			
		L	P	H								
150	9	95	160/140	75		QUR 00199 5101		QU 00199 5101				
							QUR 00199 5102		QU 00199 5102			
							QUR 00199 5103		QU 00199 5103			
							QUR 00199 5104		QU 00199 5104			
							QUR 00199 5105		QU 00199 5105			
		ECOGREEN	QUR 00199 5401		QU 00199 5401							
		205	6	140	230/200	130		QUR 00269 5101		QU 00269 5101		
									QUR 00269 5102		QU 00269 5102	
									QUR 00269 5103		QU 00269 5103	
									QUR 00269 5104		QU 00269 5104	
	QUR 00269 5105								QU 00269 5105			
ECOGREEN	QUR 00269 5401				QU 00269 5401							
295	4			200	350/300	200		QUR 00349 5101		QU 00349 5101		
									QUR 00349 5102		QU 00349 5102	
									QUR 00349 5103		QU 00349 5103	
									QUR 00349 5104		QU 00349 5104	
			QUR 00349 5105						QU 00349 5105			
		ECOGREEN	QUR 00349 5401		QU 00349 5401							
		295	4	200	350/300	145		QUR 3A249 5101		QU 3A249 5101		
									QUR 3A249 5102		QU 3A249 5102	
									QUR 3A249 5103		QU 3A249 5103	
									QUR 3A249 5104		QU 3A249 5104	
	QUR 3A249 5105								QU 3A249 5105			
ECOGREEN	QUR 3A249 5401				QU 3A249 5401							

Load capacities are net and refer to evenly distributed loads.  
The accessories and the materials stored in the truck must not protrude from the base of the truck.

**985 x 542 mm H 1813mm**

MICUBE

**QUICK + COMPAT**

266

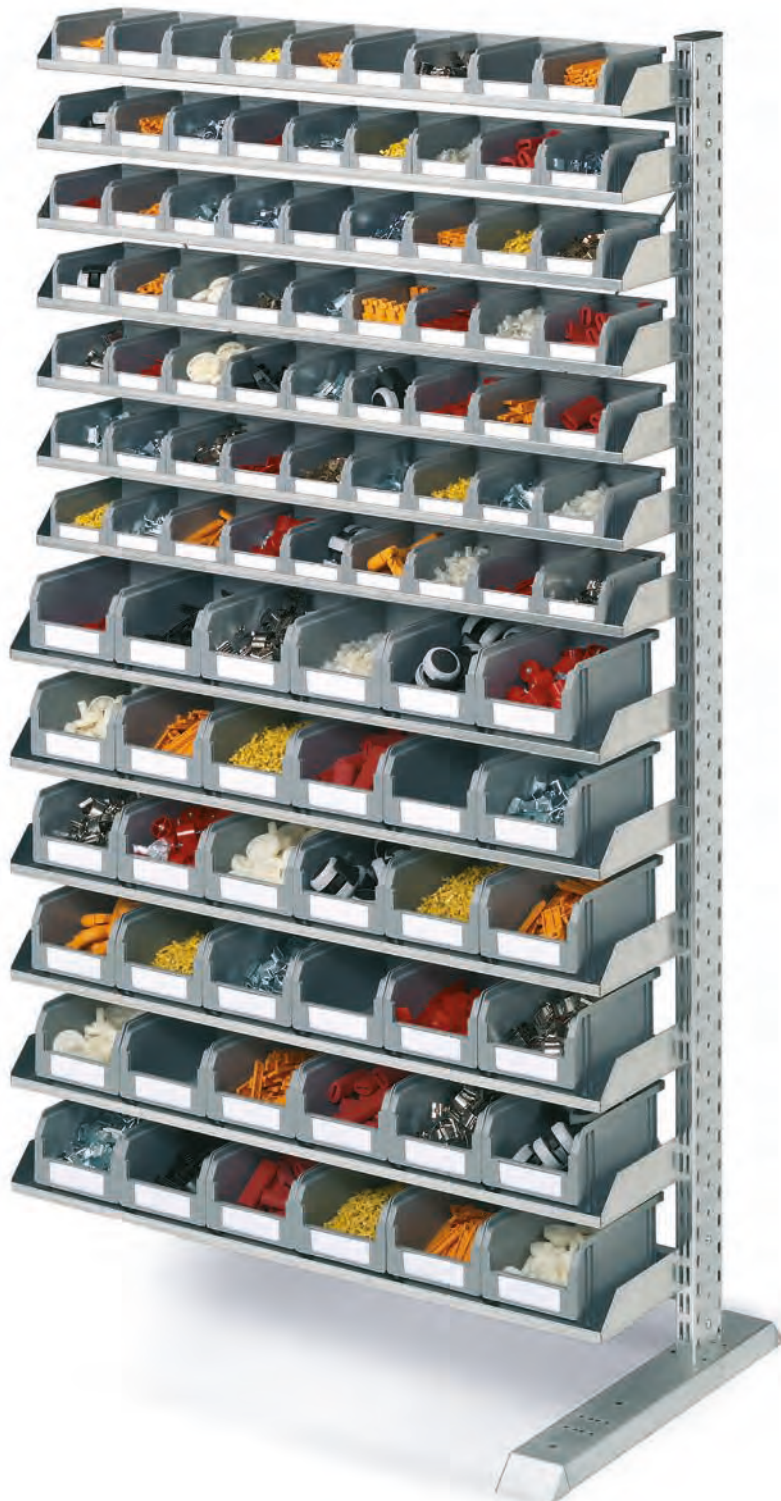

## Shelves COMPAT containers

Fixed shelf in galvanised steel

Capacity 25 kg - L=974 mm

### KIT consisting of

- Additional shelf unit 985 x 542 x 1813H mm

- 2 identical shelves complete with containers

SHELF DEPTH mm	NO. OF CONTAINERS	CONTAINER DIMENSIONS mm			MATERIAL	CODE	KIT PRICE €	CODE	PRICE OF SHELF KIT + CONTAINERS €			
		L	P	H								
150	9	95	160/140	75		QUE 00199 5101		QU 00199 5101				
							QUE 00199 5102		QU 00199 5102			
							QUE 00199 5103		QU 00199 5103			
							QUE 00199 5104		QU 00199 5104			
							QUE 00199 5105		QU 00199 5105			
		SIZE 1	ECOGREEN	QUE 00199 5401		QU 00199 5401						
		205	6	140	230/200	130		QUE 00269 5101		QU 00269 5101		
									QUE 00269 5102		QU 00269 5102	
									QUE 00269 5103		QU 00269 5103	
									QUE 00269 5104		QU 00269 5104	
	QUE 00269 5105								QU 00269 5105			
SIZE 2	ECOGREEN			QUE 00269 5401		QU 00269 5401						
295	4			200	350/300	200		QUE 00349 5101		QU 00349 5101		
									QUE 00349 5102		QU 00349 5102	
									QUE 00349 5103		QU 00349 5103	
									QUE 00349 5104		QU 00349 5104	
			QUE 00349 5105						QU 00349 5105			
		SIZE 3	ECOGREEN	QUE 00349 5401		QU 00349 5401						
		295	4	200	350/300	145		QUE 3A249 5101		QU 3A249 5101		
									QUE 3A249 5102		QU 3A249 5102	
									QUE 3A249 5103		QU 3A249 5103	
									QUE 3A249 5104		QU 3A249 5104	
	QUE 3A249 5105								QU 3A249 5105			
SIZE 3A2	ECOGREEN			QUE 3A249 5401		QU 3A249 5401						

Load capacities are net and refer to evenly distributed loads.  
The accessories and the materials stored in the truck must not protrude from the base of the truck.

**1065 x 542 mm h 1813mm**

MICUBE



## NEXIT box shelves

Tiltable shelf in galvanised steel  
Load capacity 50 kg - L=955 mm

## KIT consisting of

- Shelf unit 1065 x 542 x 1813H mm
- 2 identical shelves complete with containers

SHELF DEPTH mm	EXAMPLE	NO. OF BOXES	BOX DIMENSIONS mm			FRONT PICKING mm	MATERIAL	CODE	KIT PRICE €	CODE	PRICE OF SHELF KIT + CONTAINERS €		
			L	P	H								
220		3	300	200	120	300		QUR3212A39N101		QU3212A39N101			
							ECOGREEN	QUR3212A39N401		QU3212A39N401			
		3	300	200	170	300		QUR3217B39N101		QU3217B39N101			
							ECOGREEN	QUR3217B39N401		QU3217B39N401			
320		4	300	200	120	200		QUR3212A49N101		QU3212A49N101			
							ECOGREEN	QUR3212A49N401		QU3212A49N401			
		4	300	200	170	200		QUR3217B49N101		QU3217B49N101			
							ECOGREEN	QUR3217B49N401		QU3217B49N401			
		2	400	300	120	400		QUR4312A29N101		QU4312A29N101			
							ECOGREEN	QUR4312A29N401		QU4312A29N401			
		2	400	300	170	400		QUR4317B29N101		QU4317B29N101			
							ECOGREEN	QUR4317B29N401		QU4317B29N401			
420		3	400	300	120	300		QUR4312A39N101		QU4312A39N101			
							ECOGREEN	QUR4312A39N401		QU4312A39N401			
		3	400	300	170	300		QUR4317B39N101		QU4317B39N101			
							ECOGREEN	QUR4317B39N401		QU4317B39N401			
		3	400	300	220	300		QUR4322B39N101		QU4322B39N101			
							ECOGREEN	QUR4322B39N401		QU4322B39N401			
		600		2	600	400	120	400		QUR6412A29N101		QU6412A29N101	
									ECOGREEN	QUR6412A29N401		QU6412A29N401	
	2		600	400	170	400		QUR6417B29N101		QU6417B29N101			
							ECOGREEN	QUR6417B29N401		QU6417B29N401			
	2	600	400	220	400		QUR6422B29N101		QU6422B29N101				
						ECOGREEN	QUR6422B29N401		QU6422B29N401				
	1	800	600	120	800		QUR8612C195101		QU8612C195101				
						ECOGREEN	QUR8612C195401		QU8612C195401				
		800	600	170	800		QUR8617C195101		QU8617C195101				
						ECOGREEN	QUR8617C195401		QU8617C195401				
800	600	220	800		QUR8622C195101		QU8622C195101						
				ECOGREEN	QUR8622C195401		QU8622C195401						

Load capacities are net and refer to evenly distributed loads.  
The accessories and the materials stored in the truck must not protrude from the base of the truck.

**985 x 542 mm H 1813mm**

MICUBE



## NEXIT box shelves

Tiltable shelf in galvanised steel  
Load capacity 50 kg - L=955 mm

## KIT consisting of

- Additional shelf unit 985 x 542 x 1813H mm
- 2 identical shelves complete with containers

SHELF DEPTH mm	EXAMPLE	NO. OF BOXES	BOX DIMENSIONS mm			FRONT PICKING mm	MATERIAL	CODE	KIT PRICE €	CODE	PRICE OF SHELF KIT + CONTAINERS €
			L	P	H						
220		3	300	200	120	300		QUE3212A39N101		QU3212A39N101	
							ECOGREEN ✓	QUE3212A39N401		QU3212A39N401	
		3	300	200	170	300		QUE3217B39N101		QU3217B39N101	
							ECOGREEN ✓	QUE3217B39N401		QU3217B39N401	
320		4	300	200	120	200		QUE3212A49N101		QU3212A49N101	
							ECOGREEN ✓	QUE3212A49N401		QU3212A49N401	
		4	300	200	170	200		QUE3217B49N101		QU3217B49N101	
							ECOGREEN ✓	QUE3217B49N401		QU3217B49N401	
		2	400	300	120	400		QUE4312A29N101		QU4312A29N101	
							ECOGREEN ✓	QUE4312A29N401		QU4312A29N401	
		2	400	300	170	400		QUE4317B29N101		QU4317B29N101	
							ECOGREEN ✓	QUE4317B29N401		QU4317B29N401	
420		3	400	300	120	300		QUE4312A39N101		QU4312A39N101	
							ECOGREEN ✓	QUE4312A39N401		QU4312A39N401	
		3	400	300	170	300		QUE4317B39N101		QU4317B39N101	
							ECOGREEN ✓	QUE4317B39N401		QU4317B39N401	
		3	400	300	220	300		QUE4322B39N101		QU4322B39N101	
							ECOGREEN ✓	QUE4322B39N401		QU4322B39N401	
		2	600	400	120	400		QUE6412A29N101		QU6412A29N101	
							ECOGREEN ✓	QUE6412A29N401		QU6412A29N401	
600		2	600	400	170	400		QUE6417B29N101		QU6417B29N101	
							ECOGREEN ✓	QUE6417B29N401		QU6417B29N401	
		2	600	400	220	400		QUE6422B29N101		QU6422B29N101	
							ECOGREEN ✓	QUE6422B29N401		QU6422B29N401	
		1	800	600	120	800		QUE8612C195101		QU8612C195101	
							ECOGREEN ✓	QUE8612C195401		QU8612C195401	
		1	800	600	170	800		QUE8617C195101		QU8617C195101	
							ECOGREEN ✓	QUE8617C195401		QU8617C195401	
1	800	600	220	800		QUE8622C195101		QU8622C195101			
					ECOGREEN ✓	QUE8622C195401		QU8622C195401			

Load capacities are net and refer to evenly distributed loads.  
The accessories and the materials stored in the truck must not protrude from the base of the truck.

**1065 x 925 mm H 1813mm**

MICUBE

**QUICK + COMPAT**

272

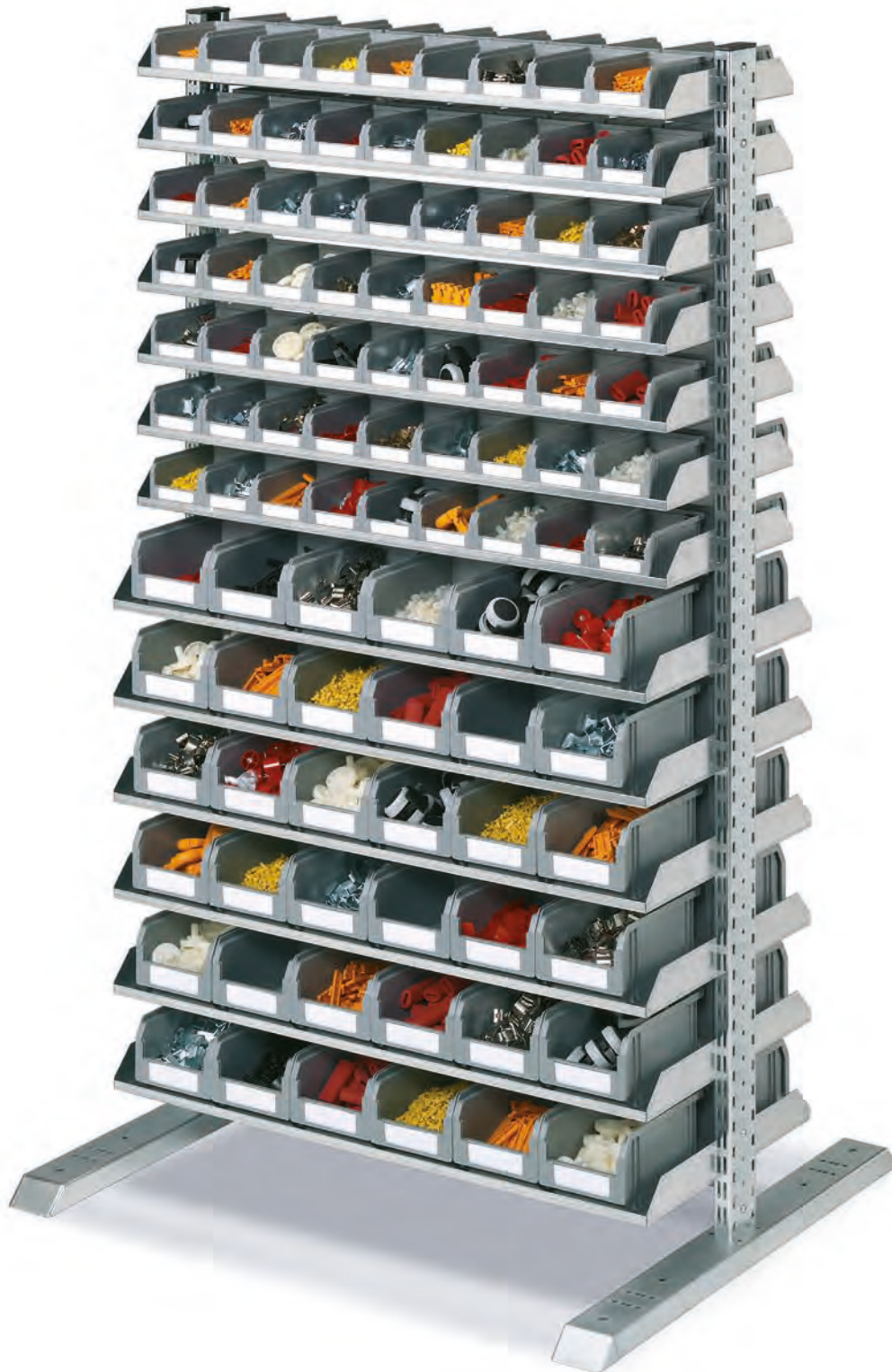



## Shelves COMPAT containers

Fixed shelf in galvanised steel

Capacity 25 kg - L=974 mm

### KIT consisting of

- Shelf unit 1065 x 925 x 1813H mm

- 2 identical shelves complete with containers

SHELF DEPTH mm	NO. OF CONTAINERS	CONTAINER DIMENSIONS mm			MATERIAL	CODE	KIT PRICE €	CODE	PRICE OF SHELF KIT + CONTAINERS €			
		L	P	H								
150	9	95	160/140	75		QU2R 00199 5101		QU 00199 5101				
							QU2R 00199 5102		QU 00199 5102			
							QU2R 00199 5103		QU 00199 5103			
							QU2R 00199 5104		QU 00199 5104			
							QU2R 00199 5105		QU 00199 5105			
		SIZE 1	ECOGREEN	QU2R 00199 5401		QU 00199 5401						
		205	6	140	230/200	130		QU2R 00269 5101		QU 00269 5101		
									QU2R 00269 5102		QU 00269 5102	
									QU2R 00269 5103		QU 00269 5103	
									QU2R 00269 5104		QU 00269 5104	
						QU2R 00269 5105			QU 00269 5105			
SIZE 2	ECOGREEN			QU2R 00269 5401		QU 00269 5401						
295	4			200	350/300	200		QU2R 00349 5101		QU 00349 5101		
									QU2R 00349 5102		QU 00349 5102	
									QU2R 00349 5103		QU 00349 5103	
									QU2R 00349 5104		QU 00349 5104	
						QU2R 00349 5105			QU 00349 5105			
		SIZE 3	ECOGREEN	QU2R 00349 5401		QU 00349 5401						
		295	4	200	350/300	145		QU2R 3A249 5101		QU 3A249 5101		
									QU2R 3A249 5102		QU 3A249 5102	
									QU2R 3A249 5103		QU 3A249 5103	
									QU2R 3A249 5104		QU 3A249 5104	
						QU2R 3A249 5105			QU 3A249 5105			
SIZE 3A2	ECOGREEN			QU2R 3A249 5401		QU 3A249 5401						

Load capacities are net and refer to evenly distributed loads.  
The accessories and the materials stored in the truck must not protrude from the base of the truck.

**985 x 925 mm H 1813mm**

1MICUBE

**QUICK + COMPAT**

274

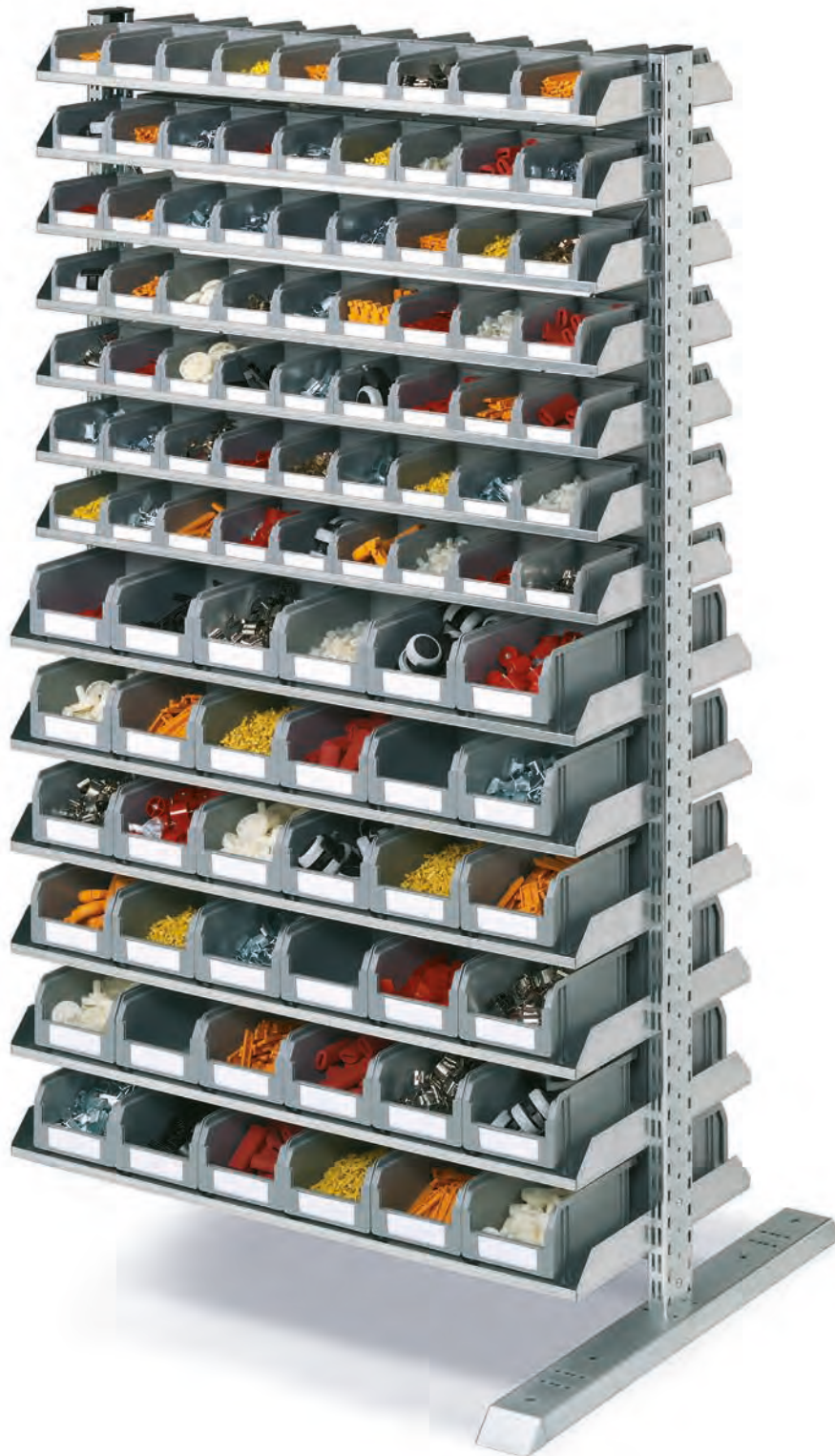

## Shelves COMPAT containers

Fixed shelf in galvanised steel

Capacity 25 kg - L=974 mm

### KIT consisting of

- Additional shelf unit 985 x 925 x 1813H mm

- 2 identical shelves complete with containers

SHELF DEPTH mm	NO. OF CONTAINERS	CONTAINER DIMENSIONS mm			MATERIAL	CODE	KIT PRICE €	CODE	PRICE OF SHELF KIT + CONTAINERS €		
		L	P	H							
150	9	95	160/140	75		QU2E 00199 5101		QU 00199 5101			
			QU2E 00199 5102			QU 00199 5102					
			QU2E 00199 5103			QU 00199 5103					
			QU2E 00199 5104			QU 00199 5104					
			QU2E 00199 5105			QU 00199 5105					
		ECOGREEN	QU2E 00199 5401		QU 00199 5401						
		205	6	140	230/200	130		QU2E 00269 5101		QU 00269 5101	
					QU2E 00269 5102			QU 00269 5102			
					QU2E 00269 5103			QU 00269 5103			
					QU2E 00269 5104			QU 00269 5104			
QU2E 00269 5105					QU 00269 5105						
ECOGREEN	QU2E 00269 5401				QU 00269 5401						
295	4			200	350/300	200		QU2E 00349 5101		QU 00349 5101	
					QU2E 00349 5102			QU 00349 5102			
					QU2E 00349 5103			QU 00349 5103			
					QU2E 00349 5104			QU 00349 5104			
		QU2E 00349 5105			QU 00349 5105						
		ECOGREEN	QU2E 00349 5401		QU 00349 5401						
		295	4	200	350/300	145		QU2E 3A249 5101		QU 3A249 5101	
					QU2E 3A249 5102			QU 3A249 5102			
					QU2E 3A249 5103			QU 3A249 5103			
					QU2E 3A249 5104			QU 3A249 5104			
QU2E 3A249 5105					QU 3A249 5105						
ECOGREEN	QU2E 3A249 5401				QU 3A249 5401						

Load capacities are net and refer to evenly distributed loads.  
The accessories and the materials stored in the truck must not protrude from the base of the truck.

**1065 x 925 mm H 1813mm**

MICUBE



## NEXIT box shelves

Tiltable shelf in galvanised steel  
Load capacity 50 kg - L=955 mm

## KIT consisting of

- Shelf unit 1065 x 925 x 1813H mm
- 2 identical shelves complete with containers

SHELF DEPTH mm	EXAMPLE	NO. OF BOXES	BOX DIMENSIONS mm			FRONT PICKING mm	MATERIAL	CODE	KIT PRICE €	CODE	PRICE OF SHELF KIT + CONTAINERS €
			L	P	H						
220		3	300	200	120	300		QU2R3212A39N101		QU3212A39N101	
							ECOGREEN	QU2R3212A39N401		QU3212A39N401	
		3	300	200	170	300		QU2R3217B39N101		QU3217B39N101	
							ECOGREEN	QU2R3217B39N401		QU3217B39N401	
320		4	300	200	120	200		QU2R3212A49N101		QU3212A49N101	
							ECOGREEN	QU2R3212A49N401		QU3212A49N401	
		4	300	200	170	200		QU2R3217B49N101		QU3217B49N101	
							ECOGREEN	QU2R3217B49N401		QU3217B49N401	
		2	400	300	120	400		QU2R4312A29N101		QU4312A29N101	
							ECOGREEN	QU2R4312A29N401		QU4312A29N401	
		2	400	300	170	400		QU2R4317B29N101		QU4317B29N101	
							ECOGREEN	QU2R4317B29N401		QU4317B29N401	
420		3	400	300	120	300		QU2R4312A39N101		QU4312A39N101	
							ECOGREEN	QU2R4312A39N401		QU4312A39N401	
		3	400	300	170	300		QU2R4317B39N101		QU4317B39N101	
							ECOGREEN	QU2R4317B39N401		QU4317B39N401	
		3	400	300	220	300		QU2R4322B39N101		QU4322B39N101	
							ECOGREEN	QU2R4322B39N401		QU4322B39N401	
		2	600	400	120	400		QU2R6412A29N101		QU6412A29N101	
							ECOGREEN	QU2R6412A29N401		QU6412A29N401	
600		2	600	400	170	400		QU2R6417B29N101		QU6417B29N101	
							ECOGREEN	QU2R6417B29N401		QU6417B29N401	
		2	600	400	220	400		QU2R6422B29N101		QU6422B29N101	
							ECOGREEN	QU2R6422B29N401		QU6422B29N401	
		1	800	600	120	800		QU2R8612C195101		QU8612C195101	
							ECOGREEN	QU2R8612C195401		QU8612C195401	
		1	800	600	170	800		QU2R8617C195101		QU8617C195101	
							ECOGREEN	QU2R8617C195401		QU8617C195401	
1	800	600	220	800		QU2R8622C195101		QU8622C195101			
					ECOGREEN	QU2R8622C195401		QU8622C195401			

Load capacities are net and refer to evenly distributed loads.  
The accessories and the materials stored in the truck must not protrude from the base of the truck.

**985 x 925 mm H 1813mm**

MICUBE



## NEXIT box shelves

Tilttable shelf in galvanised steel  
Load capacity 50 kg - L=955 mm

## KIT consisting of

- Additional shelf unit 985 x 925 x 1813H mm
- 2 identical shelves complete with containers

SHELF DEPTH mm	EXAMPLE	NO. OF BOXES	BOX DIMENSIONS mm			FRONT PICKING mm	MATERIAL	CODE	KIT PRICE €	CODE	PRICE OF SHELF KIT + CONTAINERS €		
			L	P	H								
220		3	300	200	120	300		QU2E3212A39N101		QU3212A39N101			
							ECOGREEN ✓	QU2E3212A39N401		QU3212A39N401			
		3	300	200	170	300		QU2E3217B39N101		QU3217B39N101			
							ECOGREEN ✓	QU2E3217B39N401		QU3217B39N401			
320		4	300	200	120	200		QU2E3212A49N101		QU3212A49N101			
							ECOGREEN ✓	QU2E3212A49N401		QU3212A49N401			
		4	300	200	170	200		QU2E3217B49N101		QU3217B49N101			
							ECOGREEN ✓	QU2E3217B49N401		QU3217B49N401			
		2	400	300	120	400		QU2E4312A29N101		QU4312A29N101			
							ECOGREEN ✓	QU2E4312A29N401		QU4312A29N401			
		2	400	300	170	400		QU2E4317B29N101		QU4317B29N101			
							ECOGREEN ✓	QU2E4317B29N401		QU4317B29N401			
420		3	400	300	120	300		QU2E4312A39N101		QU4312A39N101			
							ECOGREEN ✓	QU2E4312A39N401		QU4312A39N401			
		3	400	300	170	300		QU2E4317B39N101		QU4317B39N101			
							ECOGREEN ✓	QU2E4317B39N401		QU4317B39N401			
		3	400	300	220	300		QU2E4322B39N101		QU4322B39N101			
							ECOGREEN ✓	QU2E4322B39N401		QU4322B39N401			
		600		2	600	400	120	400		QU2E6412A29N101		QU6412A29N101	
									ECOGREEN ✓	QU2E6412A29N401		QU6412A29N401	
	2		600	400	170	400		QU2E6417B29N101		QU6417B29N101			
							ECOGREEN ✓	QU2E6417B29N401		QU6417B29N401			
	2	600	400	220	400		QU2E6422B29N101		QU6422B29N101				
						ECOGREEN ✓	QU2E6422B29N401		QU6422B29N401				
	1	800	600	120	800		QU2E8612C195101		QU8612C195101				
						ECOGREEN ✓	QU2E8612C195401		QU8612C195401				
1	800	600	170	800		QU2E8617C195101		QU8617C195101					
					ECOGREEN ✓	QU2E8617C195401		QU8617C195401					
1	800	600	220	800		QU2E8622C195101		QU8622C195101					
					ECOGREEN ✓	QU2E8622C195401		QU8622C195401					

Load capacities are net and refer to evenly distributed loads.  
The accessories and the materials stored in the truck must not protrude from the base of the truck.



# FRAME

The **FRAME** shelf unit is precisely sized to house Nexit, Kronos, Odette, Compat and Zeus boxes.

There are two available heights: 1010 mm and 2010 mm. The paired guides that support the box container are adjustable in height and have a pitch of 25 mm and maximum load capacity of 50 kg; boxes and containers of the same width but with

different depths and heights can be inserted in the same bay.

The load capacity of the bay is 250 kg.

The modularity of the system allows the existing systems to be extended at any time without removal of the existing one.



## UPPER SUPPORT SURFACE

iMICUBE

The surfaces are fixed to the top of each bay and, as well as strengthening the shelf unit, act as dust covers and bearing surfaces.



## SHELVES

The guides for the sliding of the boxes are fastened to the uprights and secured using the attachment clip. Adjustable height with 25 mm pitch.



## SIDES

The sides are supplied mounted and have a lateral fissure with a pitch of 25 mm and are complete with legs for fixing to the ground. Load capacity 250 kg.

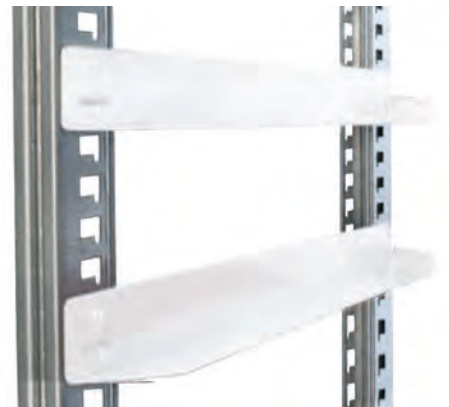

## PAIR OF RETAINING BRACKETS

The brackets are fixed to the sides of the uprights with four self-tapping screws to make the structure more stable.



Dimensions of this composition 1440x400x2010H mm



**Front picking 300 mm**  
**Depth 400 mm**



NEXIT



KRONOS



ODETTE



R-KLT



RL-KLT

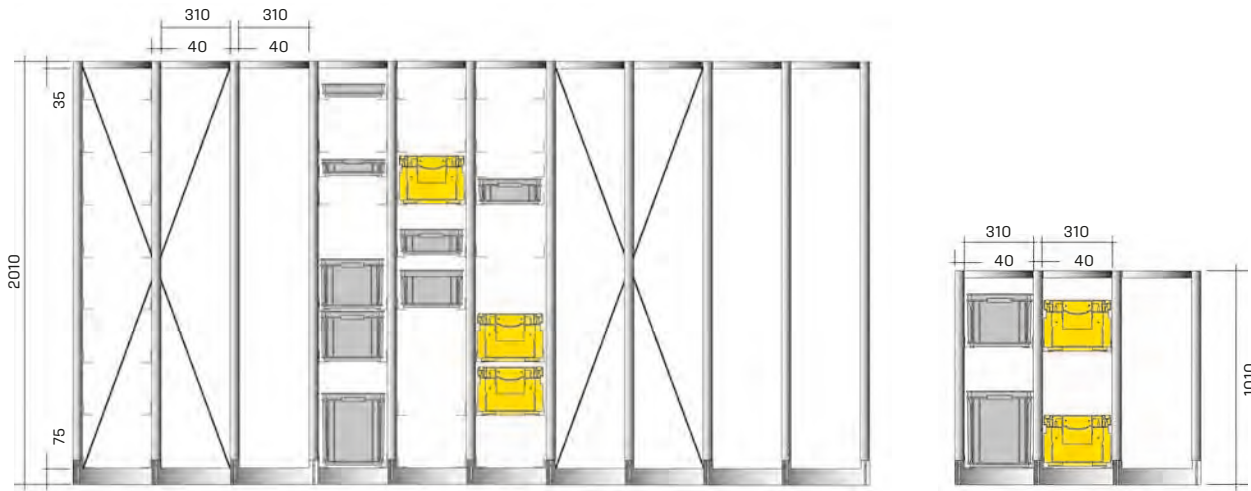

DOUBLE BAY BASE WITH CROSS SUPPORT 2010 H	ADDITIONAL SINGLE BAY 2010 H	CROSS SUPPORT	SINGLE BAY BASE 1010 H	ADDITIONAL SINGLE BAY 1010 H	GALVANISED PAIR OF GUIDES	PAIR OF ANCHOR BOLTS M8x75
250 kg LOAD CAPACITY PER BAY	250 kg LOAD CAPACITY PER BAY	1 CROSS SUPPORT EVERY 6 SINGLE BAYS	250 kg LOAD CAPACITY PER BAY	250 kg LOAD CAPACITY PER BAY	50 kg LOAD CAPACITY PER PAIR OF GUIDES	REQUIREMENT FOR FIXING TO GROUND
USABLE INSERTION HEIGHT 1900 mm - GUIDE PITCH H 25 mm	USABLE INSERTION HEIGHT 1900 mm - GUIDE PITCH H 25 mm		USABLE INSERTION HEIGHT 900 mm - GUIDE PITCH H 25 mm	USABLE INSERTION HEIGHT 900 mm - GUIDE PITCH H 25 mm	REAR END STOP	
FR2004099	FRE2004099	FRCROSS	FR1004099	FRE1004099	FRRAIL40	FRFIX

Note: fixing material consisting of 2 M8x75 mm expansion screws in steel for uncracked concrete floors equal to or greater than C20/25 class.

BOX HEIGHT	GUIDE PITCH HEIGHT	NEXIT	KRONOS	ODETTE	RfKLT	RLfKLT
55	75	⊥				
78	100	⊥				
120	150	⊥				
147	175			⊥	⊥	⊥
170	200	⊥				
220	250	⊥	⊥			
270/280	300				⊥	⊥
320	350	⊥				

Dimensions of this composition 1390x600x2010H mm



**Front picking 400 mm  
Depth 600 mm**



NEXIT



KRONOS



ODETTE



R-KLT



RL-KLT

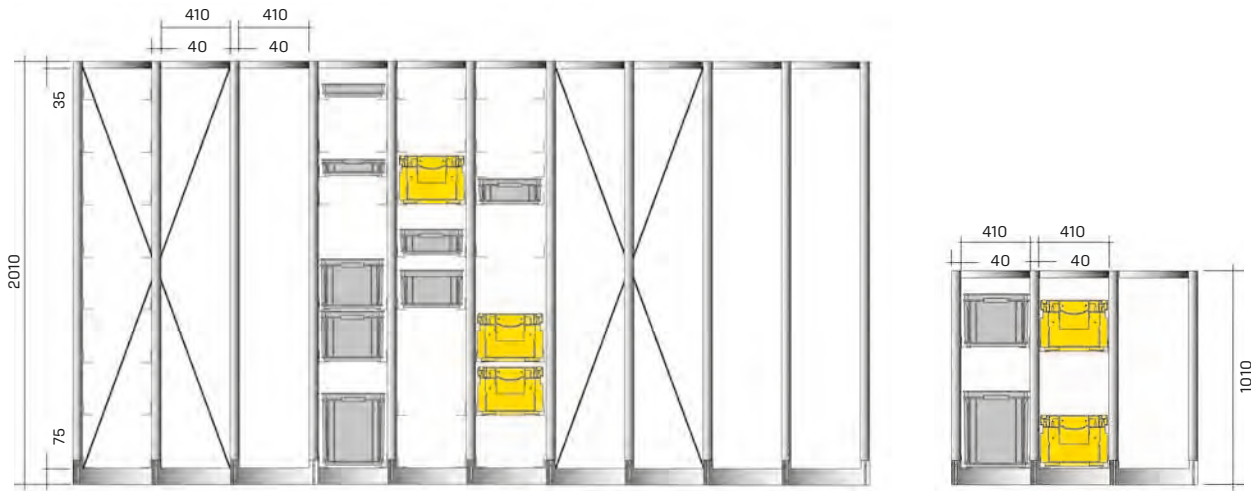

DOUBLE BAY BASE WITH CROSS SUPPORT 2010 H	ADDITIONAL SINGLE BAY 2010 H	CROSS SUPPORT	SINGLE BAY BASE 1010 H	ADDITIONAL SINGLE BAY 1010 H	GALVANISED PAIR OF GUIDES	PAIR OF ANCHOR BOLTS M8X75
250 kg LOAD CAPACITY PER BAY	250 kg LOAD CAPACITY PER BAY	1 CROSS SUPPORT EVERY 6 SINGLE BAYS	250 kg LOAD CAPACITY PER BAY	250 kg LOAD CAPACITY PER BAY	50 kg LOAD CAPACITY PER PAIR OF GUIDES	REQUIREMENT FOR FIXING TO GROUND
USABLE INSERTION HEIGHT 1900 mm - GUIDE PITCH H 25 mm	USABLE INSERTION HEIGHT 1900 mm - GUIDE PITCH H 25 mm		USABLE INSERTION HEIGHT 900 mm - GUIDE PITCH H 25 mm	USABLE INSERTION HEIGHT 900 mm - GUIDE PITCH H 25 mm	REAR END STOP	
<b>FR2006099</b>	<b>FRE2006099</b>	<b>FRCROSS</b>	<b>FR1006099</b>	<b>FRE1006099</b>	<b>FRRAIL60</b>	<b>FRFIX</b>

Note: fixing material consisting of 2 M8x75 mm expansion screws in steel for uncracked concrete floors equal to or greater than C20/25 class.

BOX HEIGHT	GUIDE PITCH HEIGHT	NEXIT	KRONOS	ODETTE	RfKLT	RLfKLT
78	100	⊥				
120	150	⊥				
147	175				⊥	⊥
170	200	⊥				
220	250	⊥	⊥	⊥		
270/280	300	⊥			⊥	⊥
320	350	⊥	⊥	⊥		
430	450	⊥				



Dimensions of this composition 1355x350x2010H mm

**Front picking 200 mm**  
**Depth 350 mm**



**COMPAT**



**ZEUS**



DOUBLE BAY BASE WITH CROSS SUPPORT 2010 H	ADDITIONAL SINGLE BAY 2010 H	CROSS SUPPORT	SINGLE BAY BASE 1010 H	ADDITIONAL SINGLE BAY 1010 H	GALVANISED PAIR OF GUIDES	PAIR OF ANCHOR BOLTS M8X75
250 kg LOAD CAPACITY PER BAY	250 kg LOAD CAPACITY PER BAY	1 CROSS SUPPORT EVERY 6 SINGLE BAYS	250 kg LOAD CAPACITY PER BAY	250 kg LOAD CAPACITY PER BAY	50 kg LOAD CAPACITY PER PAIR OF GUIDES	REQUIREMENT FOR FIXING TO GROUND
USABLE INSERTION HEIGHT 1900 mm - GUIDE PITCH H 25 mm	USABLE INSERTION HEIGHT 1900 mm - GUIDE PITCH H 25 mm		USABLE INSERTION HEIGHT 900 mm - GUIDE PITCH H 25 mm	USABLE INSERTION HEIGHT 900 mm - GUIDE PITCH H 25 mm	REAR END STOP	
FR2003599	FRE2003599	FRCROSS	FR1003599	FRE1003599	FRRAIL35	FRFIX

Note: fixing material consisting of 2 M8x75 mm expansion screws in steel for uncracked concrete floors equal to or greater than C20/25 class.

BOX HEIGHT	GUIDE PITCH HEIGHT	COMPAT	ZEUS
145	175	☒	☒
200	225	☒	

Dimensions of this composition 1492x500x2010H mm



**Front picking 300 mm**  
**Depth 500 mm**



**COMPAT**



**ZEUS**



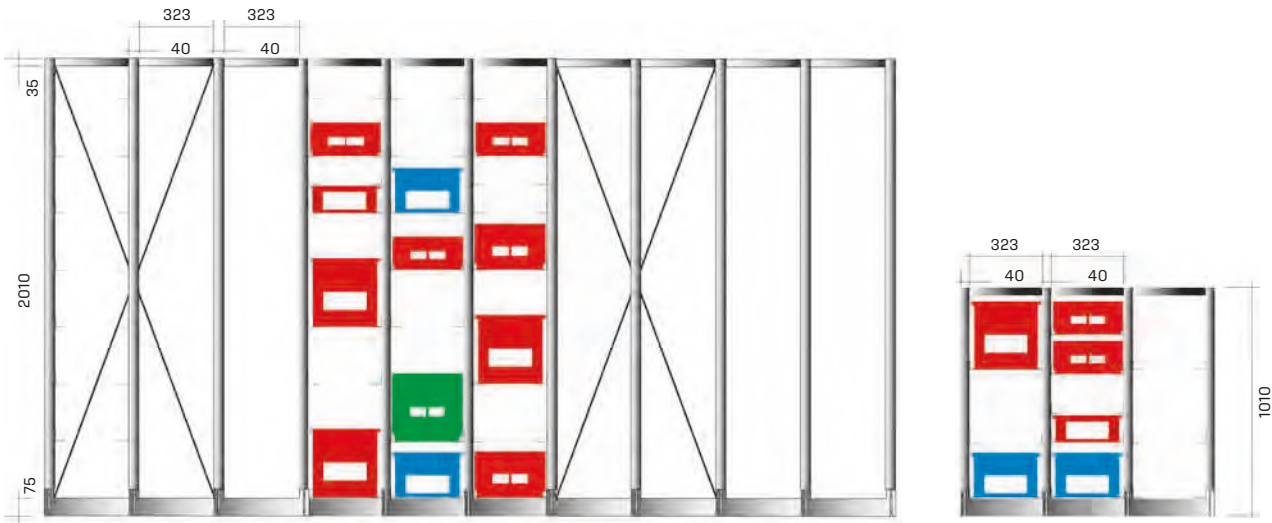

DOUBLE BAY BASE WITH CROSS SUPPORT 2010 H	ADDITIONAL SINGLE BAY 2010 H	CROSS SUPPORT	SINGLE BAY BASE 1010 H	ADDITIONAL SINGLE BAY 1010 H	GALVANISED PAIR OF GUIDES	PAIR OF ANCHOR BOLTS M8X75
250 kg LOAD CAPACITY PER BAY	250 kg LOAD CAPACITY PER BAY	1 CROSS SUPPORT EVERY 6 SINGLE BAYS	250 kg LOAD CAPACITY PER BAY	250 kg LOAD CAPACITY PER BAY	50 kg LOAD CAPACITY PER PAIR OF GUIDES	REQUIREMENT FOR FIXING TO GROUND
USABLE INSERTION HEIGHT 1900 mm - GUIDE PITCH H 25 mm	USABLE INSERTION HEIGHT 1900 mm - GUIDE PITCH H 25 mm		USABLE INSERTION HEIGHT 900 mm - GUIDE PITCH H 25 mm	USABLE INSERTION HEIGHT 900 mm - GUIDE PITCH H 25 mm	REAR END STOP	
FR2005099	FRE2005099	FRCROSS	FR1005099	FRE1005099	FRRAIL50	FRFIX

Note: fixing material consisting of 2 M8x75 mm expansion screws in steel for uncracked concrete floors equal to or greater than C20/25 class.

BOX HEIGHT	GUIDE PITCH HEIGHT	COMPAT	ZEUS
120	150		⊗
145	175	⊗	
200	225	⊗	⊗
300	325	⊗	⊗



# PICK

**PICK** container holder cabinets are the ideal commercial and industrial storage solution for small parts and small items.

They consist of a steel sheet structure with height-adjustable shelves, which can be variable in number according to the user's needs.

They are compatible for insertion of Compat containers series size 1 or 2 and Practibox container series, from 3 to 9 tilting.

These cabinets can be supplied without door or with door and lock.

## ADJUSTABLE SHELVES

iMICUBE

The cabinet can be partitioned with height-adjustable shelves, 25 mm in pitch, with insertion of as many shelves as needed.

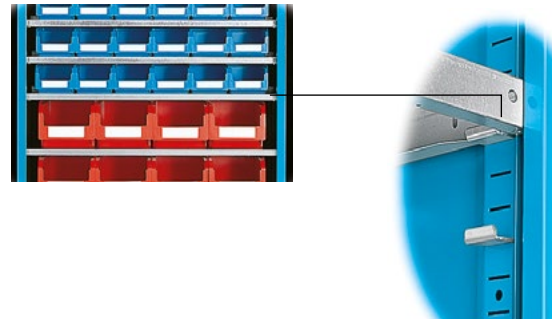

## CONTAINERS

The PICK cabinets can be fitted with Compat series containers in sizes 1 and 2, as well as the Practibox tilting drawer unit series, numbers 3 - 4 - 5 - 6 - 9.



## REAR STOP

A rear stop can be applied to the shelf to prevent the depthways displacement of container size 1



## SAFETY

For safety purposes, PICK container holder cabinets must be fixed to the floor or wall.



### Some examples of possible compositions with PICK 100 cabinets



700 x 270 H 1000 mm

iMICUBE



Cabinet load capacity **450 kg**.

Cabinet available in the following colours:

**grey** RAL7000 code 01  
**green** RAL6011 code 02  
**blue** RAL5012 code 04  
**grey** RAL7035 code 08

Other colours available on request.



RAL 7000 .01    RAL 6011 .02    RAL 5012 .04    RAL 7035 .08

COMP.	HINGED DOORS	LOCK	SHELVES	COMPAT SIZE 1	STOPS FOR CONTAINERS	COMPAT SIZE 2	SHELF LOAD CAPACITY KG	CABINET COLOUR	ARTICLE	PRICE €
1			8	54	9		50	blue 04	PK1000104	
2	■	■	8	54	9		50	blue 04	PK1001104	
3			6	24	4	12	50	blue 04	PK1000204	
4	■	■	6	24	4	12	50	blue 04	PK1001204	
5			5			24	50	blue 04	PK1000304	
6	■	■	5			24	50	blue 04	PK1001304	

⚠ Safety: for safety purposes, the container holder cabinets must be fixed to the floor or wall.

## Some examples of possible compositions with PICK 165 cabinets

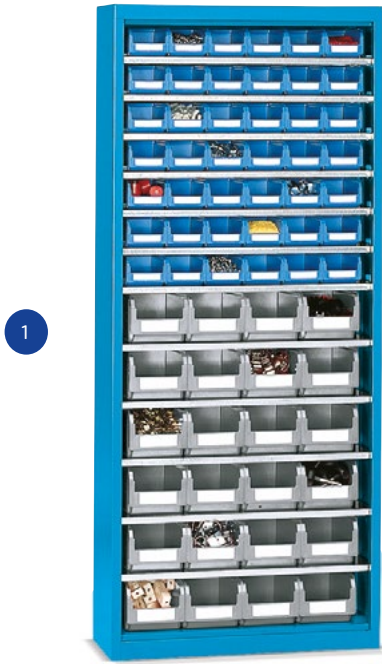



Cabinet load capacity **500 kg**.

Cabinet available in the following colours:

**grey** RAL7000 code 01  
**green** RAL6011 code 02  
**blue** RAL5012 code 04  
**grey** RAL7035 code 08

Other colours available on request.

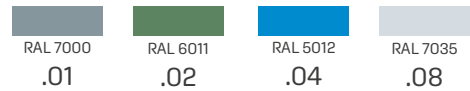

COMP.	HINGED DOORS	LOCK	SHELVES	COMPAT SIZE 1	STOPS FOR CONTAINERS	COMPAT SIZE 2	SHELF LOAD CAPACITY KG	CABINET COLOUR	ARTICLE	PRICE €
1			12	42	7	24	50	blue 04	PK16501 04	
2	■	■	12	42	7	24	50	blue 04	PK16511 04	
COMP.	HINGED DOORS	LOCK	PRACTIBOX HOLDER FRAME	PRACTIBOX PR 9077...	PRACTIBOX PR 6112...	PRACTIBOX PR 5164...	PRACTIBOX PR 4206...	PRACTIBOX PR 3240...	ARTICLE	PRICE €
3	■	■	1x1500H	2	4	3	1	1	PK16512 04	

⚠ Safety: for safety purposes, the container holder cabinets must be fixed to the floor or wall.

### Some examples of possible compositions with PICK 200 cabinets

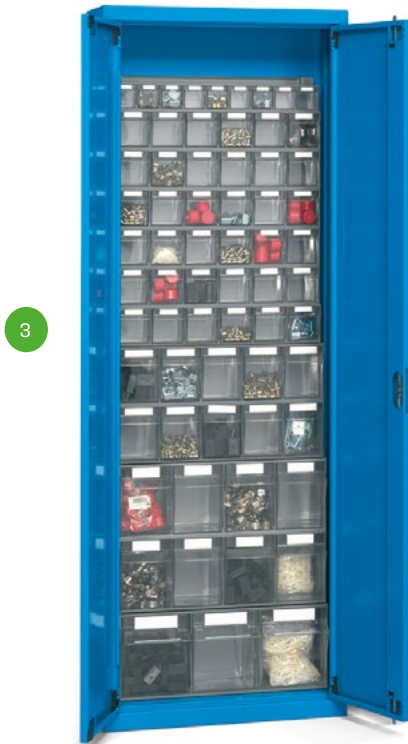
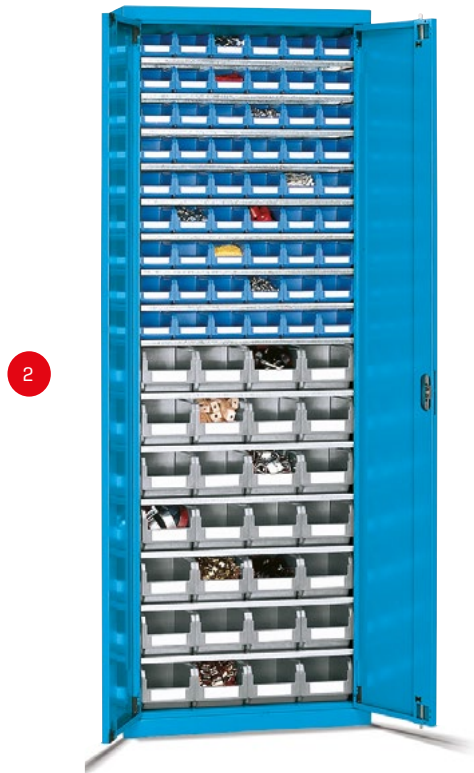
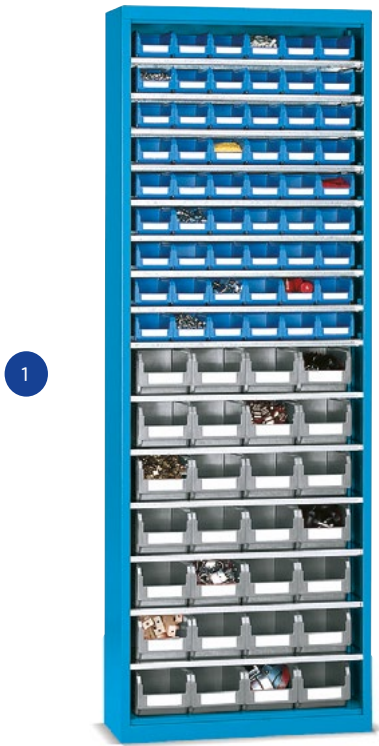





Cabinet load capacity **500 kg**.

Cabinet available in the following colours:

- grey** RAL7000 code 01
- green** RAL6011 code 02
- blue** RAL5012 code 04
- grey** RAL7035 code 08

Other colours available on request.

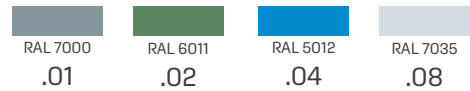

COMP.	HINGED DOORS	LOCK	SHELVES	COMPAT SIZE 1	STOPS FOR CONTAINERS	COMPAT SIZE 2	SHELF LOAD CAPACITY KG	CABINET COLOUR	ARTICLE	PRICE €
1			15	54	9	28	50	blue 04	PK2000104	
2	■	■	15	54	9	28	50	blue 04	PK2001104	
COMP.	HINGED DOORS	LOCK	PRACTIBOX HOLDER FRAME	PRACTIBOX PR 9077...	PRACTIBOX PR 6112...	PRACTIBOX PR 5164...	PRACTIBOX PR 4206...	PRACTIBOX PR 3240...	ARTICLE	PRICE €
3	■	■	1x1750H	1	6	2	2	1	PK2001204	

⚠ Safety: for safety purposes, the container holder cabinets must be fixed to the floor or wall.

**Empty cabinets  
for other configurations**



1

H 1000 mm



2



3

H 1650 mm



4



5

H 2000 mm



6

# 700 x 270 H 1000/1650/2000 mm

iMICUBE

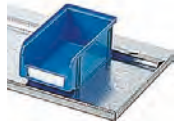
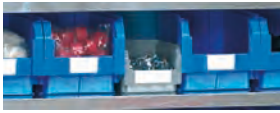

When size 1 containers are inserted, the stop bracket on the shelf must be used.  
Art. PK STOP -

Galvanized steel shelf, complete with 4 hooks  
Art. PK SHELF -

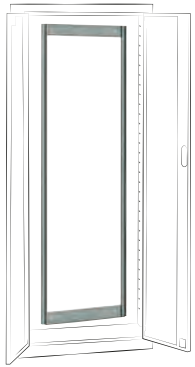

Practibox holder frame for cabinets 2000 mm in height, including fixing screws  
Art. PK FR20 01 -

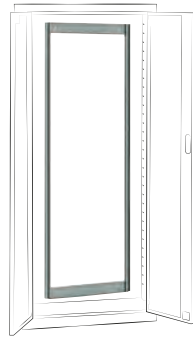

Practibox holder frame for cabinets 1650 mm in height, including fixing screws  
Art. PK FR16 01 -

Cabinet load capacity **500 kg**.

Cabinet available in the following colours:

**grey** RAL7000 code 01  
**green** RAL6011 code 02  
**blue** RAL5012 code 04  
**grey** RAL7035 code 08

Other colours available on request.



2 HILTI anchor bolts suitable for uncracked concrete floors greater than or equal to C20/25 class  
Recommended anchor bolt traction: 2.9 kN  
Anchor bolt diameter: Ø 6 mm  
Art. PK FIX -

RAL 7000	RAL 6011	RAL 5012	RAL 7035
.01	.02	.04	.08

COMP.	HINGED DOORS	LOCK	SHELVES	COMPAT SIZE 1	STOPS FOR CONTAINERS	COMPAT SIZE 2	SHELF LOAD CAPACITY KG	CABINET COLOUR	ARTICLE	PRICE €
1								blue 04	PK10000 04	
2	fl	fl						blue 04	PK10010 04	
3								blue 04	PK16500 04	
4	fl	fl						blue 04	PK16510 04	
5								blue 04	PK20000 04	
6	fl	fl						blue 04	PK20010 04	

⚠ Safety: for safety purposes, the container holder cabinets must be fixed to the floor or wall.



# SQUARE

**SQUARE** shelf units are stackable and can be used to create complete wall shelving installations units, in accordance with available space.

SQUARE shelf units consist of steel structures in RAL7000 grey colour and 8 different configurations, for Zeus series boxes and Compat series containers.

The warehouse configurations of SQUARE shelf

units can be easily modified since the individual compositions are monobloc structures – a solution that not only allows for rapid preparation of the area, but also imparts considerable strength even at full load.

# DUST PROTECTION COVER

IMICUBE

Use of the dust cover also protects the material from accidental loads.

Constructed in RAL7000 grey steel.



# WORKTOP

The worktop allows the creation of comfortable, practical workstations for the distribution of materials.

Constructed in RAL7000 grey steel.



# PLINTH

The plinth raises the shelf unit 85 mm from the ground, insulates it from the floor and prevents the bottom row of boxes/containers from touching the ground during extraction.

Constructed in RAL7000 grey steel.



# CONTAINERS

Individual boxes/containers can be extracted easily and quickly and a special hook positioned at the front on the guides prevents total or accidental ejection.

## COMPAT



size 3



size 4A5



size 4



size 5

## ZEUS



size 272-4



size 272-4A5



size 272-5



size 3

1



1025 x 310 x H 885 mm

2

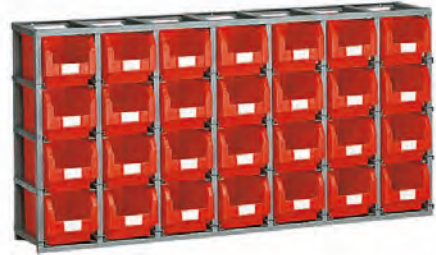

1765 x 310 x H 885 mm

3



1075 x 460 x H 885 mm

4



1765 x 460 x H 885 mm



size 4



size 272-4

5



1765 x 460 x H 1300 mm



size 4A5



size 272-4A5

6



1765 x 460 x H 1300 mm



size 5



size 272-5

7



1125 x 660 x H 1180 mm

8



1670 x 660 x H 1180 mm

## FRAME STACKABILITY

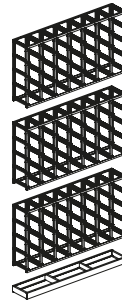

FRAME		SINGLE FRAME LOAD CAPACITYKG	BOX LOAD CAPACITYKG	NUMBER OF BOXES / CONTAINERS	PRICE € EXCLUDING CONTAINERS	FRAME		SINGLE FRAME LOAD CAPACITYKG	BOX LOAD CAPACITYKG	NUMBER OF BOXES / CONTAINERS	PRICE € EXCLUDING CONTAINERS		
1	1 frame	960	60	16		5	1 frame	2400	80	30			
	SQ16003	2 frames stacked	960				60	SQ30004	2 frames stacked			2400	80
	3 frames stacked	640	40				SQ30004	3 frames stacked	1500			50	
SQB1023	Plinth	1020 x 315 x H 85 mm				SQB1764	Plinth	1765 x 465 x H 85 mm					
SQC1023	Dust protection cover	1020 X 315 x H 20 mm				SQC1764	Dust protection cover	1765 x 465 x H 20 mm					
SQW1023	Worktop	1025 x 315 x H 32 mm				SQW1774	Worktop	1770 x 465 x H 32 mm					
2	1 frame	1680	60	28		6	1 frame	1600	80	20			
	SQ28003	2 frames stacked	1680				60	SQ204A5	2 frames stacked			1000	80
	3 frames stacked	1120	40				SQ204A5	3 frames stacked	1000			50	
SQB1763	Plinth	1765 x 315 x H 85 mm				SQB1764	Plinth	1765 x 465 x 85h mm					
SQC1763	Dust protection cover	1765 x 315 x H 20 mm				SQC1764	Dust protection cover	1765 x 465 x 20h mm					
SQW1773	Worktop	1770 x 315 x H 32 mm				SQW1774	Worktop	1770 x 465 x 32h mm					
3	1 frame	1200	100	12		7	1 frame	1200	200	6			
	SQ12004	2 frames stacked	1200				100	SQ06005	2 frames stacked			1200	200
	3 frames stacked	1200	100				SQ06005	3 frames stacked	1200			200	
SQB1074	Plinth	1070 x 465 x H 85 mm				SQB1126	Plinth	1125 x 660 x H 155 mm					
SQC1074	Dust protection cover	1070 x 465 x H 20 mm				SQC1126	Dust protection cover	1120 x 665 x H 30 mm					
SQW1074	Worktop	1075 x 465 x H 32 mm											
4	1 frame	1600	80	20		8	1 frame	1800	200	9			
	SQ20004	2 frames stacked	1600				80	SQ09005	2 frames stacked			1800	200
	3 frames stacked	160	80				SQ09005	3 frames stacked	1800			200	
SQB1764	Plinth	1765 x 465 x H 85 mm				SQB1676	Plinth	1670 x 660 x H 155 mm					
SQC1764	Dust protection cover	1765 x 465 x H 20 mm				SQC1666	Dust protection cover	1667 x 665 x H 30 mm					
SQW1774	Worktop	1770 x 465 x H 32 mm											

# GENERAL TERMS AND CONDITIONS OF SALE FOR IMILANI PRODUCTS

## 1. DEFINITIONS

1.1 WITHIN THIS AGREEMENT, THE TERMS SPECIFIED BELOW SHALL HAVE THE FOLLOWING MEANING:

- A) BUYER: ANY TRADER WHO PURCHASES OR PROPOSES TO PURCHASE FROM IMILANI THE PRODUCTS MARKETED BY IMILANI;
- B) ORDER CONFIRMATION: REFERS TO THE DOCUMENT WITH WHICH IMILANI ACCEPTS A PROPOSAL;
- C) INCOTERMS2010: INCOTERMS OF THE INTERNATIONAL CHAMBER OF COMMERCE, IN THE TEXT IN FORCE AT THE DATE OF FINALISING THE ORDER;
- D) ORDER(S): MEANS THE CONTRACT, FORMED BY THE PROPOSAL SUBMITTED BY THE BUYER AND THE ORDER CONFIRMATION ISSUED BY IMILANI, WHICH REGULATES THE SUPPLY OF PRODUCTS;
- E) PARTS: IMILANI AND THE BUYER;
- F) PRODUCTS: GOODS COVERED BY A SALE OR SALE NEGOTIATION;
- G) PROPOSAL(S): THE REQUEST(S) TO PURCHASE THE PRODUCTS SENT BY THE BUYER TO IMILANI.

## 2. FIELD OF APPLICATION

2.1 THESE CONDITIONS OF SALE (HEREINAFTER THE "CONDITIONS") APPLY BETWEEN IMILANI SRL (HEREINAFTER "IMILANI") AND THE BUYER EVEN WHEN THEY HAVE NOT BEEN AGREED UPON OR REFERRED TO BY THE PARTIES.

2.2 ANY EXCEPTIONS SHALL BE VALID ONLY IF CONTAINED IN SEPARATE DOCUMENTS SIGNED BY THE PARTIES.

2.3 THE GENERAL TERMS AND CONDITIONS OF SALE ARE AN INTEGRAL PART OF ALL ORDERS, INCLUDING WHEN FINALISED BY TELEPHONE, VERBALLY, BY FAX, EMAIL OR INTERNET.

2.4 IN THE EVENT OF DISCREPANCIES BETWEEN THE PROVISIONS REFERRED TO HEREIN AND THOSE CONTAINED IN THE ORDER, THE LATTER SHALL IN ANY CASE PREVAIL.

## 3. FINALISATION OF THE ORDER

3.1 THE BUYER MAY SUBMIT PROPOSALS TO IMILANI EITHER DIRECTLY OR THROUGH AGENTS AND THEIR REPRESENTATIVES. HOWEVER, AN ORDER SHALL BE FINALISED ONLY AFTER AN ORDER CONFIRMATION HAS BEEN SENT BY IMILANI FOR EACH INDIVIDUAL PROPOSAL.

3.2 IMILANI EXPRESSLY RESERVES THE RIGHT TO EVALUATE ANY PROPOSAL AND SHALL NOT BE BOUND TO THE ACCEPTANCE THEREOF.

3.3 ANY SUPPLY OFFERS FROM IMILANI TO THE BUYER SHALL ONLY BE CONSIDERED FIRM AND IRREVOCABLE IF QUALIFIED AS SUCH IN WRITING BY IMILANI.

3.4 THE REGISTERED OFFICES OF IMILANI SHALL ALWAYS BE THE PLACE OF FINALISATION OF THE ORDER, INCLUDING ORDERS THAT ARE FINALISED ELECTRONICALLY.

## 4. DELIVERY TERMS

4.1 IMILANI SHALL DELIVER THE PRODUCTS EX-WORKS (EXW INCOTERMS2010). IF REQUESTED, IMILANI SHALL TAKE CARE OF THE TRANSPORTATION OF THE PRODUCTS, AT THE RISK, COST AND EXPENSE OF THE BUYER. THE PAYMENT OF TRANSPORT COSTS BY IMILANI SHALL NOT AFFECT THE RISKS OF THE SHIPMENT, WHICH SHALL CONTINUE TO BE BORNE BY THE BUYER AT THE LATEST UPON DELIVERY OF THE PRODUCTS TO THE FIRST CARRIER.

4.2 THE DELIVERY OF THE PRODUCTS MUST TAKE PLACE BY THE DEADLINE SPECIFIED IN THE ORDER, CALCULATED IN WORKING DAYS. HOWEVER, THE DELIVERY DEADLINE IS PURELY INDICATIVE AND IS NOT AN ESSENTIAL TERM OF THE CONTRACT AND, IN ANY CASE, DOES NOT INCLUDE TRANSPORT TIME.

4.3 UPON RECEIPT OF THE NOTICE OF GOODS READY FOR PICK-UP, THE BUYER MUST COLLECT THE PRODUCTS WITHIN A DEADLINE OF 10 (TEN) DAYS. SHOULD THE BUYER DEFAULT, THE PRODUCTS MAY BE STORED OUTDOORS, WITH IMILANI RELEASED FROM ANY LIABILITY, AND ALL GUARANTEES BEING FORFEITED IN FAVOUR OF IMILANI; THE BUYER SHALL BE CHARGED FOR ANY HANDLING AND STORAGE COSTS INCURRED BY IMILANI, WHICH MAY ALSO, AT ITS DISCRETION, HAVE THE PRODUCTS PLACED IN STORAGE AT THE BUYER'S EXPENSE.

4.4 IMILANI SHALL BE ENTITLED TO ISSUE A REGULAR INVOICE WITHIN 10 (TEN) DAYS FROM THE NOTICE OF GOODS READY FOR PICK UP.

## 5. COMPLAINTS

5.1 ANY COMPLAINTS REGARDING THE PACKAGING CONDITION, QUANTITY, NUMBER OR EXTERNAL CHARACTERISTICS OF THE PRODUCTS (APPARENT DEFECTS) MUST BE SUBMITTED TO IMILANI IN WRITING, UNDER PENALTY OF FORFEITURE, WITHIN 8 (EIGHT) BUSINESS DAYS FROM THE DATE OF RECEIPT OF THE PRODUCTS.

5.2 ANY COMPLAINTS RELATING TO DEFECTS THAT CANNOT BE IDENTIFIED THROUGH DILIGENT CONTROL UPON RECEIPT (HIDDEN DEFECTS) MUST BE SUBMITTED TO IMILANI, UNDER PENALTY OF FORFEITURE, WITHIN 8 (EIGHT) DAYS FROM THE DATE OF DISCOVERY OF THE DEFECT AND REPORTED TO IMILANI IN THE MANNER PROVIDED UNDER THE COMPLAINTS / RETURNS CONDITIONS.

5.3 IN NO CASE SHALL AGENTS, CUSTOMERS OR INTERMEDIARIES OF IMILANI HAVE THE POWER TO REPRESENT IMILANI OR TAKE ANY BINDING OBLIGATIONS ON BEHALF OF IMILANI VIS À VIS THE BUYER OR OTHER THIRD PARTIES. TO THIS END, ANY NOTICE RELATING TO FAULTS OR DEFECTS OF THE PRODUCTS SHALL BE INVALID AND INEFFECTIVE IF MADE TO AGENTS, CUSTOMERS OR INTERMEDIARIES OF IMILANI.

## 6. PRICES

6.1 THE PRICES OF THE PRODUCTS SHALL BE THOSE SPECIFIED IN THE IMILANI PRICE LIST IN FORCE AT THE TIME THE ORDER IS FINALISED OR, IF THE PRODUCT IS NOT INCLUDED IN THE PRICE LIST OR THE PRICE LIST IS NOT AVAILABLE, THOSE SPECIFIED IN THE ORDER CONFIRMATION.

6.2 UNLESS OTHERWISE AGREED, THE AFOREMENTIONED PRICES SHALL BE CALCULATED EX WORKS (EXW INCOTERMS2010). THESE PRICES DO NOT INCLUDE THE COSTS OF SPECIAL PACKAGING, SHIPPING AND TRANSPORT FROM IMILANI'S PREMISES, WHICH SHALL BE BORNE BY THE BUYER. UNLESS OTHERWISE AGREED, THE BUYER SHALL ALSO BEAR ALL EXPENSES, TAXES OR DUTIES INHERENT IN THE SALE OF THE PRODUCTS, INCLUDING THE COSTS OF ALL CUSTOMS FORMALITIES (AS WELL AS ANY DUTIES, TAXES AND OTHER OFFICIAL CHARGES TO BE PAID FOR EXPORTING THE PRODUCTS).

## 7. PAYMENT CONDITIONS

7.1 WHERE THE TERMS OF PAYMENT ARE NOT SPECIFIED IN THE ORDER, THE PAYMENT MUST BE MADE WITHIN 30 DAYS FROM THE END OF MONTH INVOICE DATE, BY BANK TRANSFER. THE PAYMENT SHALL BE CONSIDERED PAID MADE WHEN THE SUM BECOMES AVAILABLE TO IMILANI AT ITS BANK IN ITALY.

7.2 IF THE PARTIES AGREED ON AN ADVANCE PAYMENT WITHOUT FURTHER SPECIFICATIONS, IT IS ASSUMED THAT THE ADVANCE PAYMENT REFERS TO THE ENTIRE PRICE OF THE PRODUCTS INCLUDED IN THE SUPPLY ORDER.

7.3 IF THE PARTIES HAVE AGREED ON PAYMENT BY DIRECT REMITTANCE, THIS SHALL BE DONE BY SWIFT TRANSFER - WITH FIXED VALUE DATE IN FAVOUR OF IMILANI ON THE DAY THE PAYMENT IS DUE - AT THE BANK SPECIFIED BY IMILANI.

7.4 IN THE EVENT OF PAYMENT DELAYED UNTIL AFTER THE AGREED DATE, DEFAULT INTEREST AT THE STATUTORY RATE SHALL BE APPLIED TO THE BUYER. IN ADDITION, IMILANI SHALL BE REIMBURSED FOR ANY COSTS INCURRED IN THE RECOVERY OF SUMS NOT PROMPTLY PAID.

7.5 THE BUYER IS NOT AUTHORISED TO MAKE ANY DEDUCTION FROM THE AGREED PRICE (E.G. IN CASE OF ALLEGED PRODUCT DEFECTS), WITHOUT PRIOR WRITTEN AGREEMENT WITH IMILANI.

## 8. FORCE MAJEURE

8.1 BOTH THE BUYER AND IMILANI MAY SUSPEND THE PERFORMANCE OF THEIR CONTRACTUAL OBLIGATIONS WHEN SUCH PERFORMANCE BECOMES IMPOSSIBLE OR UNREASONABLY BURDENSOME DUE TO AN UNFORESEEABLE IMPEDIMENT NOT UNDER THEIR CONTROL, SUCH AS FOR EXAMPLE, STRIKES, BOYCOTTS, LOCKOUTS, FIRES, WARS, RIOTS AND REVOLUTIONS, REQUISITIONS, EMBARGOS OR INTERRUPTIONS IN ENERGY SUPPLY.

8.2 THE PARTY WISHING TO INVOKE THIS CLAUSE MUST IMMEDIATELY INFORM THE OTHER IN WRITING THAT A FORCE MAJEURE CIRCUMSTANCE HAS OCCURRED AS WELL AS WHEN SUCH CIRCUMSTANCE NO LONGER EXISTS.

8.3 IF THE SUSPENSION DUE TO FORCE MAJEURE LASTS MORE THAN EIGHT WEEKS, EACH PARTY SHALL HAVE THE RIGHT TO TERMINATE THE ORDER, SUBJECT TO 10 DAYS' NOTICE, TO BE CONVEYED TO THE OTHER IN WRITING.

## 9. CHANGE IN THE BUYER'S FINANCIAL SITUATION

9.1 IMILANI SHALL BE ENTITLED TO SUSPEND THE FULFILMENT OF THE OBLIGATIONS ARISING FROM THE SUPPLY OF THE PRODUCTS IN THE EVENT THAT THE BUYER'S FINANCIAL SITUATION BECOMES SUCH AS TO SERIOUSLY ENDANGER THE BUYER'S PERFORMANCE OF ITS OWN OBLIGATIONS, UNLESS A SUITABLE GUARANTEE IS GIVEN.

## 10. APPLICABLE LAW AND JURISDICTION

10.1 THE GENERAL TERMS AND CONDITIONS OF SALE AND THE ORDERS ENTERED INTO BETWEEN IMILANI AND THE BUYER SHALL BE GOVERNED BY ITALIAN LAW.

10.2 FOR ANY DISPUTE REGARDING THE INTERPRETATION, PERFORMANCE, BREACH OR TERMINATION OF THESE GENERAL TERMS AND CONDITIONS OF SALE, THE COURT OF VICENZA SHALL HAVE EXCLUSIVE JURISDICTION, INCLUDING IN THE EVENT OF JOINDER OF PROCEEDINGS.

## 11. FINAL CLAUSES

11.1 SHOULD ONE OF THE PARTIES FAIL TO TAKE LEGAL ACTION OR EXERCISE A RIGHT UNDER THESE GENERAL TERMS AND CONDITIONS OF SALE, SUCH ACQUIESCENT CONDUCT MAY NOT BE INTERPRETED AS A FINAL WAIVER TO TAKE SUCH LEGAL ACTION OR EXERCISE SUCH RIGHTS IN THE FUTURE.

11.2 THE SALE OF PRODUCTS BY IMILANI TO THE BUYER DOES NOT GIVE THE LATTER ANY EXCLUSIVE TERRITORIAL RIGHT NOR DOES IT ALLOW THE BUYER TO TAKE ON THE STATUS OF DISTRIBUTOR OR RESELLER OF IMILANI.

11.3 ANY COMMUNICATION FROM THE BUYER TO IMILANI IN RELATION TO THESE GENERAL TERMS AND CONDITIONS OF SALE MUST BE SENT TO THE FOLLOWING CERTIFIED E-MAIL ADDRESS: IMILANISRL@LEGALMAIL.IT. THE AFOREMENTIONED COMMUNICATIONS SHALL TAKE EFFECT UPON RECEIPT BY THE RECIPIENT.

## 12. PRIVACY

12.1 IN ACCORDANCE WITH THE PROVISIONS OF LEGISLATIVE DECREE 196/03, BY ACCEPTING THIS CONTRACT, THE BUYER DECLARES THAT IT IS AWARE, AND EXPRESSLY AGREES, THAT ITS "PERSONAL DATA", PROVIDED (ALSO VERBALLY) BY ITSELF OR ACQUIRED DURING SALE TRANSACTIONS, IS KEPT WITH IMILANI IN ITS (PAPER, ELECTRONIC OR TELECOMMUNICATIONS) ARCHIVES AND PROCESSED AS PART OF THE CONDUCT OF BUSINESS ACTIVITIES OF IMILANI FOR MANAGEMENT PURPOSES, THE FULFILMENT OF LEGAL OBLIGATIONS, AND FOR STATISTICAL, COMMERCIAL, MARKETING, PROMOTIONAL AND CREDIT PROTECTION PURPOSES. SUCH DATA MAY ALSO BE: (A) DISCLOSED TO COMPANIES, ENTITIES, CONSORTIA OR ASSOCIATIONS RESPONSIBLE FOR CREDIT PROTECTION, (B) DISCLOSED/DISSEMINATED TO SUBSIDIARIES, PARENT COMPANIES OR ASSOCIATES ENGAGED IN COMMERCIAL, MARKET RESEARCH, MARKETING, MANAGEMENT OR IT MANAGEMENT ACTIVITIES; OR SUCH COMPANIES CAN BE GIVEN ACCESS TO THE AFOREMENTIONED ARCHIVES. IN RELATION TO THE PROCESSING OF SAID DATA, THE BUYER MAY EXERCISE THE RIGHTS INDICATED IN ART. 7 LEGISLATIVE DECREE 196/03 AND IMILANI HAS AN OBLIGATION TO COMMUNICATE WITHOUT DELAY ANY REQUESTS PURSUANT TO THAT ARTICLE. THE DATA CONTROLLER IS IMILANI IN THE PERSON OF ITS PRO-TEMPORE LEGAL REPRESENTATIVE. THE DATA CAN BE PROCESSED AT THE COMPANY'S REGISTERED OFFICES OR AT TAX CONSULTING FIRMS, AS WELL AS AT THE PREMISES OF ANY OTHER PROFESSIONALS THAT HAVE BEEN TASKED WITH PROCESSING THE ACCOUNTS AND ANY OTHER RELEVANT ASSIGNMENTS.





**iMilani**

innovative  
italian  
ideas

**iMilani srl**

Via Capitano Alessio, 109  
36027 Rosà (VI) – Italy

Tel +39 0424 583100  
info@imilani.it  
www.imilani.com

A brand of:  
**i'M**